



Integra[®] MicroFrance[®]

Integra ENT - Plastic surgery catalogue

Table of contents	ii	Osteotome	22
Warranty and Customer Service Information	iv	Guarded osteotome	23
Indications / Contre-indications	v	Double guarded osteotome	24
Speculum with handle	2	Fine osteotome	25
Adapter for cold light cable	2	Guarded osteotome, curved	25
Cold light cable	2	Guarded osteotome, straight	25
Self-retaining speculum with fiber optic	2	Straight osteotome, graduated	25
Self-retaining speculum with handle	2	Other osteotome, straight curette	26
Angled dissecting forceps	3	Straight rasp	27
Forceps, serrated jaws	3	Curved rasp	28
Forceps, spoon jaws	3	Double-end rasp, 210 mm	29
Forceps with teeth	3	Other rasp	30
Syringe	4	Nasal splint, Cartilage template, Crushing press, Bone forceps	31
Injection needle	4	Double-action rongeur	32
Pushing syringe	4	Angled forceps	33
Replacement tube	4	Double-action bone rongeur	34
Syringe	4	Septum forceps	35
Washer for syringe	4	Small scissors, pointed blades	36
Elevator, raspatory	5-6	Long scissors, pointed blades	37
Suction tube elevator with finger control	7-8	Small scissors, blunt	38
Jankowski	8	Long curved scissors, blunt	39
Lempert	8	Metzenbaum scissors	40
Micro suction irrigation tube	8	Mayo scissors	41
Wertheimer	8	Angled scissors	42-43
Scalpel handle	9	Scissors, serrated blades	44
Knife	10	Straight scissors, serrated bayonet blades	44
Angled knife	10	Straight scissors, serrated blades	44
Straight knife	10	Wire cutting dural scissors	44
Swivel knife	10	Dural scissors, serrated blades	45
Raspatory	11-12	Fine dissecting forceps	46
Curved raspatory	11	Forceps jaws with teeth	46
Sharp curved raspatory	12	Forceps serrated jaws	46
Straight raspatory	12	Forceps with teeth and platform	46
Retractor	13-18	Adson dissecting forceps	47
Articulated retractor	13	Other fine dissecting forceps	48
Blunt double retractor	18	Forceps with horizontal teeth	48
Blunt retractor	13, 15, 17, 18		
Double retractor	13, 16, 18		
Retractor with prongs	15		
Sharp retractor	13, 15, 17		
Skin hook	14		
Mallet	19		
Straight chisel- Straight gouge	20		
Gouge	21		

Medium dissecting forceps	49-50	Small scissors bayonet blades	75
Forceps serrated jaws	49, 50	Large scissors bayonet blades	76
Forceps with teeth	50	Facelift scissors spatula	77
Forceps with teeth and platform	49, 50	Lifting	78-79
Dissecting forceps 180 mm	51	Facelift forceps with teeth	78
Dissecting forceps 200 mm	52	Facelift retractor	79
Medium bipolar dissecting forceps	53	Breast	80-81
Bipolar cable	53	Breast areola marker	80
With serrated jaws	53	Breast curved elevator	81
With smooth jaws	53	Breast tensor	81
With teeth	53	Spatulated elevator	80
Bipolar dissecting forceps 200 mm	54	Stainless steel cup, universal tray, oiling spray, sterilization case	82
Medium monopolar dissecting forceps	55	Numerical index	83
Large monopolar dissecting forceps	56	Table for corresponding manufacturer part numbers	89
Tungsten needle-holder	57-58		
Large tungsten needle-holder	59		
Fine haemostatic forceps	60		
Medium haemostatic forceps	61		
Haemostatic forceps, serrated jaws	62		
Strong haemostatic forceps	63		
Otoplasty	64		
Micro surgery	65		
Irrigation tube	65		
Jewelers forceps	65		
Micro dissecting forceps	65		
Micro scissors	66		
Needle-holder	66		
Silicone cover	66		
Vascular clamp	65		
Gilbert instruments, Hand set	67-68		
Gilbert instruments, Bone Set	69-70		
Mouth-gag	71		
Malleable blade retractor, Double retractor blunt	72		
Maxillary	73		
Curved elevator	74		
Curved osteotome	74		
Curved raspatory	74		
Drill burr	73		
Hook	74		
Retractor	73		
Sharp hook	73		
Spreader	73		
Wire pass	74		

Integra Limited Warranty

Please refer to the warranty included in the packaging of each product to know the applicable warranty.

Contacts Customer service:

International

+33 (0) 4 37 47 59 50
+33 (0) 4 37 47 59 25 (fax)
csemea@integralife.com

France

+33 (0) 4 37 47 59 10
+33 (0) 4 37 47 59 29 (Fax)
custservfrance@integralife.com

Belgium & Luxembourg

+32 (0) 2 257 4130
+32 (0) 2 253 2466 (Fax)
custsvcbenelux@integralife.com

United Kingdom

+44 (0) 1264 312 725
+44 (0) 1264 312 821 (Fax)
custsvcs.uk@integralife.com

Netherlands

+31(0) 852 083 167
+31(0) 207 093 627 (Fax)
custsvcnetherlands@integralife.com

Italy

+39 (0) 2 577 8921
+39 (0) 2 575 113 71 (Fax)
custsvcitaly@integralife.com

MicroFrance® ENT Instrumentation

INDICATIONS

- All the medical devices showed in this catalogue have indications for diagnosis and/or ENT surgery.
- Sizes are not contractual and are given for information purposes only.

CONTRAINDICATIONS

- Do not use in indications other than the indications mentioned in the DFU or Labeling.

How to read the catalogue

The diagram illustrates the layout of a catalogue page. At the top, a green header contains the word "Diagnosis" and the "INTEGRA" logo. Below this, five instruments are displayed. Each instrument has a circular detail view at the top, a full-scale image in the middle, and a table at the bottom. The instruments are: Marquet (90° hook), Legent (45° hook), Blunt hook 90°, Blunt hook 45°, Cotton carrier/twist end, and Angled probe caustic holder. The tables provide product references and dimensions for each instrument.

Blunt hook 90°		Blunt hook 45°		Cotton carrier/twist end		Angled probe caustic holder	
MCO805	160mm	MCO807	160mm	7719-2	140mm	7731	110mm
2mm	2,5mm	1mm		Ø 1,2mm			working length 80mm

DOCUMENT FOR USE IN EUROPE, MIDDLE-EAST AND AFRICA ONLY.

Explanation of the table reference and complementary product description

Title or subtitles	
global complementary description	
Product Ref.1	complementary description1
Product Ref.2	complementary description2

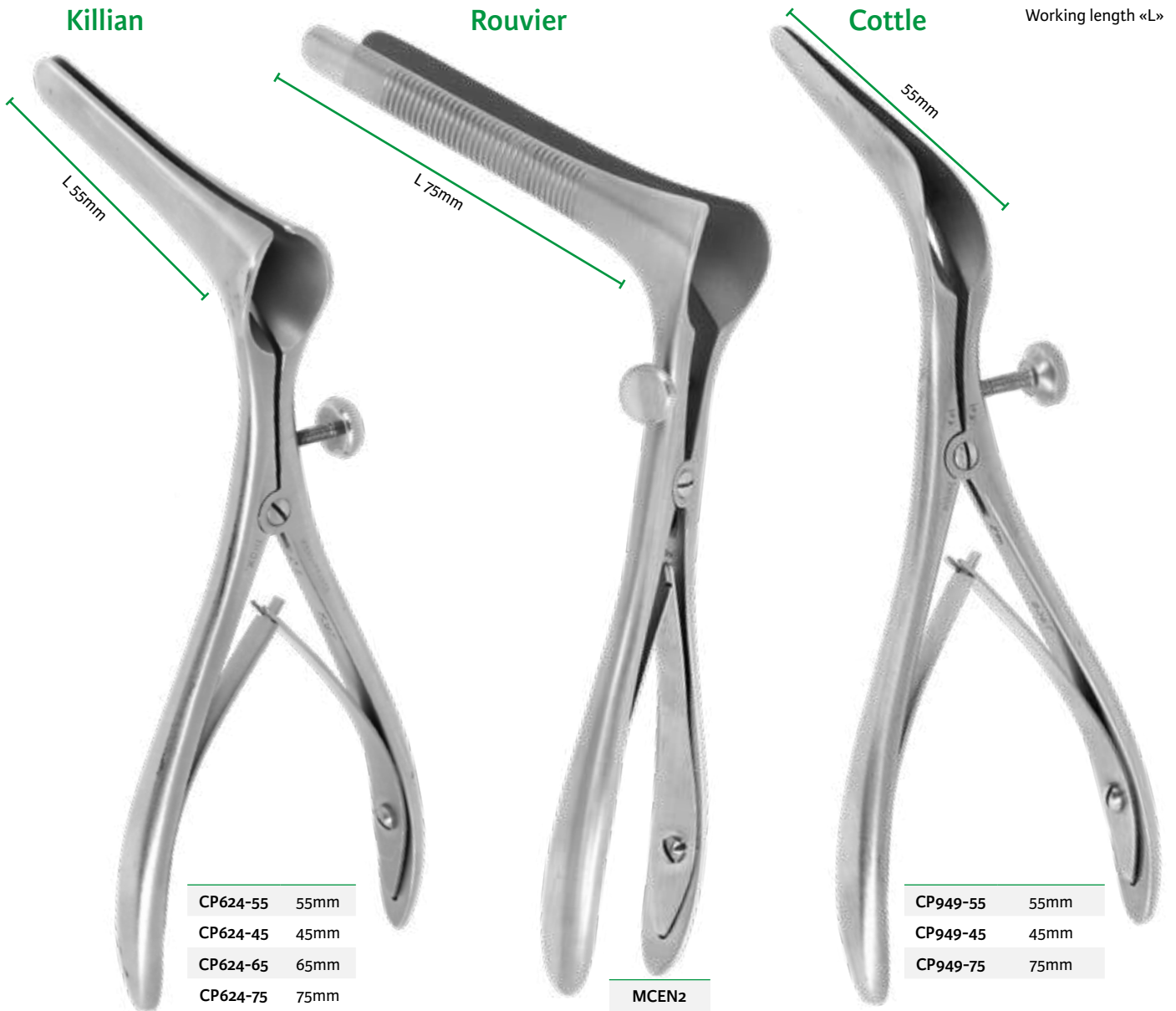

Self-retaining speculum with fiber optic - Cold light cable 220cm - Adapter for cold light cable



^(*)Not a medical device

^(D)Distributed by Integra MicroFrance SAS (France) - For corresponding manufacturer part numbers, see table in annex

Lucae



7726MF

Politzer



7732-1

150mm

7726MF	7727	7728
serrated jaws 1x12mm	spoon jaws	with teeth

120mm

7732-1	7733	7734
serrated jaws 1.5x14mm	spoon jaws	with teeth

Syringe

Génia

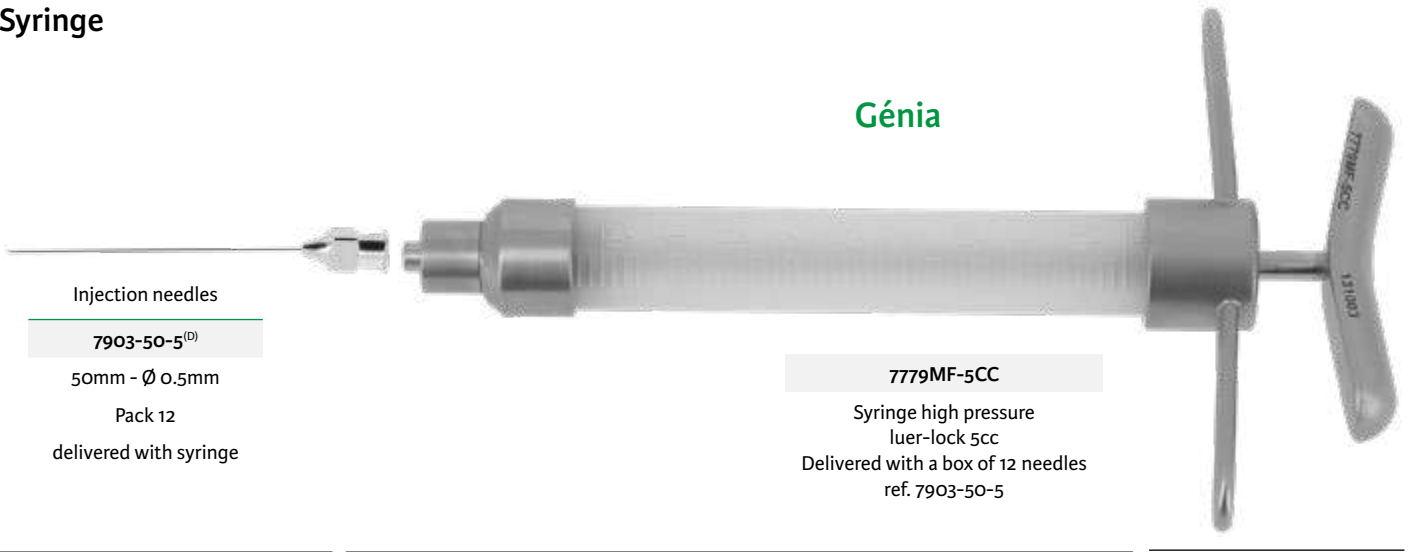

Injection needles

7903-50-5^(D)

50mm - Ø 0.5mm

Pack 12

delivered with syringe

7779MF-5CC

Syringe high pressure
luer-lock 5cc
Delivered with a box of 12 needles
ref. 7903-50-5

Grey washer luer

Replacement tube

White washer piston



7779MF-2

Pack 6



7779MF-3



7779MF-1

Pack 6



Pushing syringe

7783-12

Pack 2



Chouard

for syringe, single use, luer-lock 12cc

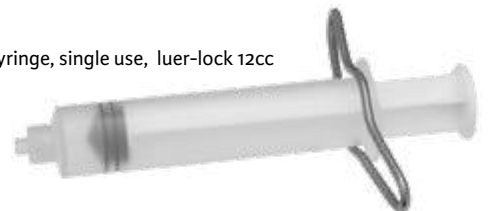

Injection needle



7903-50-5^(D)

50mm - Ø 0.5mm

Pack 12

for syringe 7779MF-5CC

^(D) Distributed by Integra MicroFrance SAS (France) - For corresponding manufacturer part numbers, see table in annex

Sébileau

Fleury

Freer

Howarth



190mm

CP985

5mm



180mm

MCO305

8.5mm



160mm

MCO803

2.5mm



185mm

CP611

5mm



220mm

CP625

Cottle

McKenty



220mm
CP626



240mm
CP627



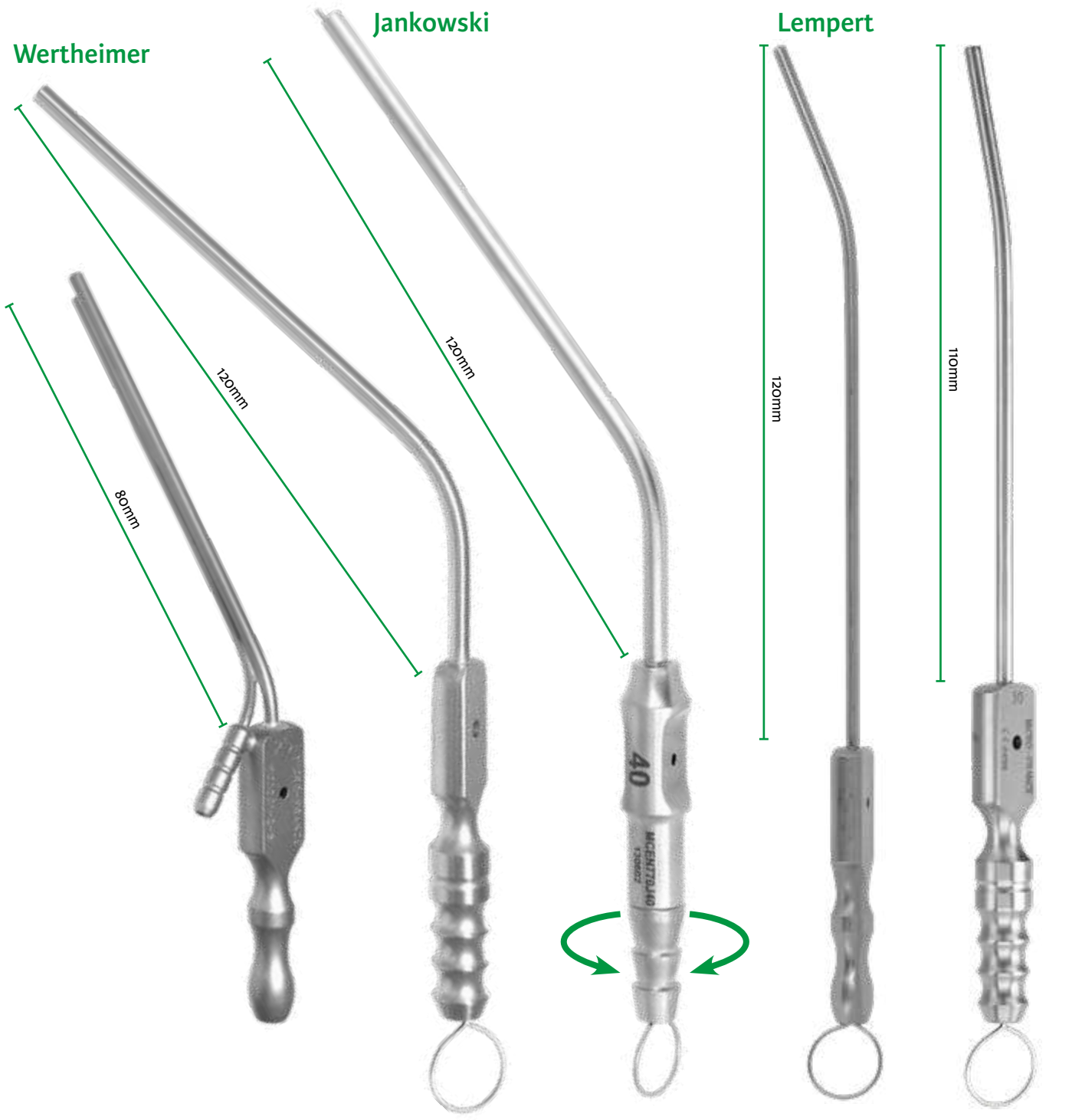

- 1.5mm
- 2mm
- 2.5mm
- 3mm
- 3.5mm
- 4mm

Wertheimer	
MCO201-2-5	2.5mm
MCO201-3-0	3mm

Wertheimer	
MCO770-1-5	1.5mm
MCO770-2-0	2mm
MCO770-2-5	2.5mm
MCO770-3-0	3mm
MCO770-3-5	3.5mm
MCO770-4-0	4mm

Jankowski	
MCEN770J40	4mm
MCEN770J30	3mm

Lempert	
MCO771-2-5	2.5mm
MCO771-3-0	3mm
MCO771-4-0	4mm

CP330-3-0	3mm
CP330-4-0	4mm



120mm

160mm

200mm

150mm

120mm

1003IG^(D)

1005I^(D)

1003LI^(D)

CP821

1004IG^(D)

N° 3

N° 7

N° 3L

N° 4

use with blades 11/15

blades 23

^(D) Distributed by Integra MicroFrance SAS (France) - For corresponding manufacturer part numbers, see table in annex

Ballenger



200mm	
CP622-4	4mm
215mm	
3714164	3mm
3714166	5mm

Joseph



160mm	
CP333	angled

Joseph



160mm	
3714678	
7mm	

Farabeuf

Fleury

Sébileau

Plester



150mm

7787-10

10mm



170mm

MCO979

6.5mm



150mm

CP825

4mm



180mm

MCO988

7.5mm



195mm

3724059

6.5mm

Joseph

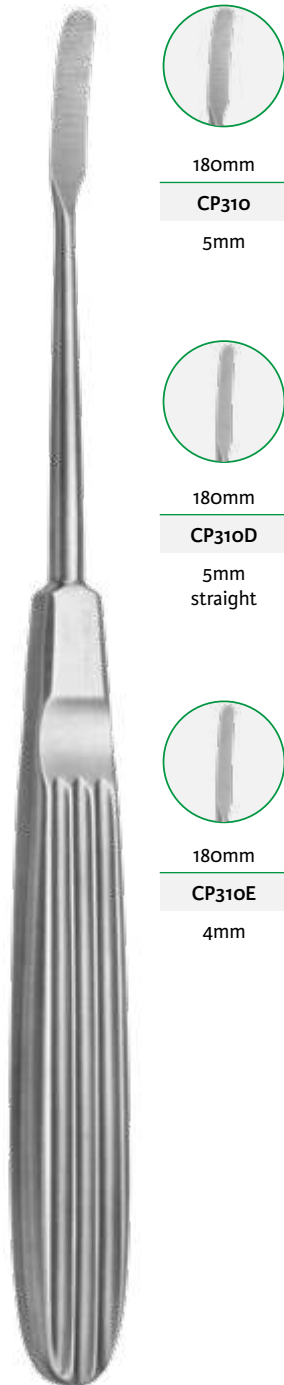

180mm

CP310

5mm



180mm

CP310D

5mm
straight

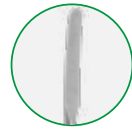

180mm

CP310E

4mm

CP310

Obwegeser



Obwegeser

180mm

CP344A

5mm

CP344B

7mm

CP344C

11mm

Obwegeser-Tessier

180mm - sharp

CP344AT

5mm

CP344BT

7mm

CP344CT

11mm



Obwegeser

190mm

CP344D

7mm
curved

CP344E

7mm
very curved

Obwegeser-Tessier

190mm - sharp

CP344DT

7mm
curved

CP344ET

7mm
very curved

CP344A

Farabeuf



140mm	120mm
7768-1	7768
Pack 2	Pack 2

Desmarres



140mm
CP822-12
12mm
CP822-10
10mm
CP822-14
14mm

Gillies



180mm
CP17
3mm - sharp
CP17-1
2mm - sharp
M812A
2mm blunt

Gillies



145mm
CP17-3
2mm
CP17-2
3mm



145mm
CP628
5mm

Humby



110mm
CP941
articulated

Kleinert-Kutz



160mm

- 3714024 3mm
- 3714025 5mm
- 3714026 7mm

Cottle



145mm

- 3714107 4mm
- very curved
- 3714108 4mm
- 3714109 5mm

Sisson



150mm

- 3714111 6mm
- blunt

Converse



180mm

- 3714364 2.5mm

Frazier



130mm

- 3724256 3.5mm

Knapp



150mm

3714027

8mm

3714028

blunt

Volkmann



140mm

CP21-3

sharp

CP21A-3

blunt



150mm

7782-1-2



180mm

CP335



160mm

CP609

3 sharp prongs

80mm
CP340

Claoué



110mm
CP341

Converse



95mm
CP331 CP331-1
sharp blunt

Kilner



125mm
CP803

Jost



120mm
CP338



130mm
CP339



Aufricht



170mm

CP306 45mm

Cottle



130mm

3714187

Cottle



3714182

130mm

3714182 left tip sharp
right ball

3714183 right tip sharp
left ball

Joseph



CP23-4

4mm



CP23-6

6mm



CP23-8

8mm



CP23A-8

8mm
blunt



CP23-10

10mm

160mm

CP23-10

10mm



220mm

CP630

with loop and ball

Ragnell



160mm

CP632

Dufourmentel



170mm

CP947

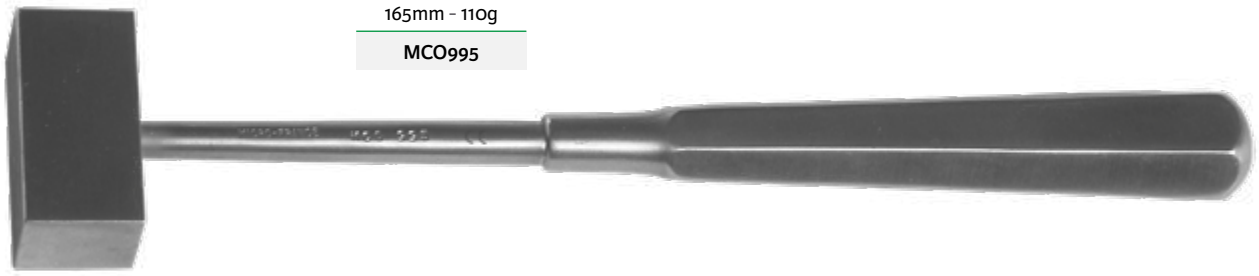

165mm - 110g

MCO995



Lombard

185mm - 330g

7766



180mm - 200g

CP907

1 teflon head



180mm - 230g

CP300

Jost



Chisel
straight
180mm

CP801-7	7mm
CP801-10	10mm

Fleury



Gouge
straight
130mm

MCO214-13-10	1mm
MCO214-13-20	2mm
MCO214-13-40	4mm
MCO214-13-60	6mm
MCO214-13-80	8mm

Ballenger

Metzenbaum



straight, V Shaped	
150mm	
3714055	2mm
3714056	4mm
3714057	6mm
3714058	8mm

straight, V Shaped	
150mm	
3714320	5mm

Bayonet	
150mm	
CP823-5	5mm

bayonet, V Shaped	
150mm	
CP824-5	5mm

Aiach



160mm
CP317
16mm

Pollet-Pech



160mm
CP318
13mm

Marchac



180mm
CP304-10

Size	curved	straight
2mm	CP304B-2	CP304-2
3mm	CP304B-3	CP304-3
4mm	CP304B-4	CP304-4
5mm	CP304B-5	CP304-5
6mm	CP304B-6	CP304-6
7mm	-	CP304-7
8mm	CP304B-8	CP304-8
9mm	-	CP304-9
10mm	CP304B-10	CP304-10
11mm	-	CP304-11
12mm	CP304B-12	CP304-12
14mm	-	CP304-14
15mm	-	CP304-15
16mm	-	CP304-16

Tessier

Jost

Marchac

Claoué

Silver



CP315

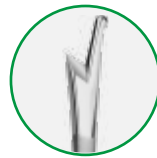

CP305

Pech-Marchac

Lindas



CP315D
curved right

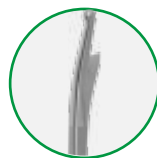

CP305L
curved left



CP315G
curved left

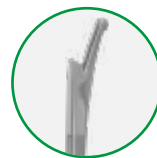

CP305R
curved right



3714098
curved right



3714099
curved left



180mm

CP316

180mm

CP802

180mm

CP315

180mm

CP305

180mm

3714098

Mac-Indoe



180mm
CP314-14
14mm
Osteotome gouge

Robin



160mm
CP309-14-16



CP309-8-12
8 - 12mm

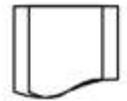

CP309-10-14
10 - 14mm

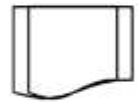

CP309-12-16
12 - 16mm

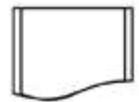

CP309-14-16
14 - 16mm



CP309-14-18
14 - 18mm

Cottle



195mm
CP8o8-6
6mm

Cottle



195mm
CP8o6
6mm

Cottle



190mm
CP8o7
5mm

Becker

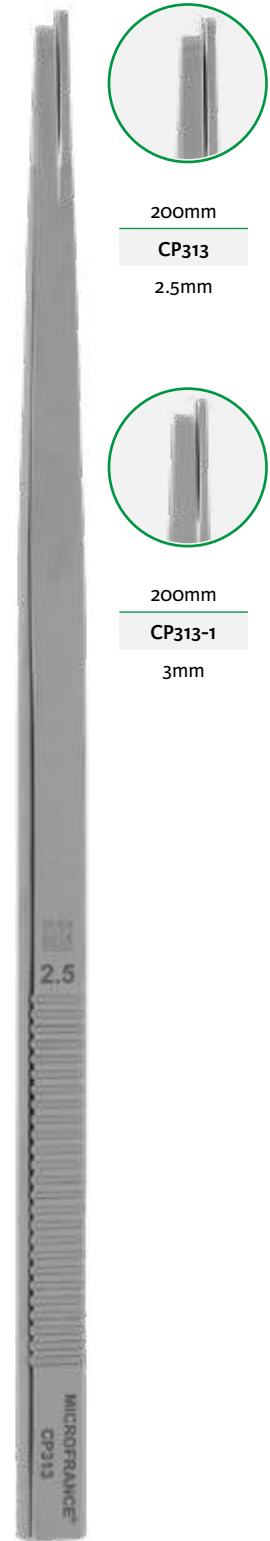

200mm
CP313
2.5mm

Other osteotome

Parkès



170mm
3714096
4mm

Straight curette

Volkman



CP302-6

170mm		
○	CP302-2	2mm
○	CP302-3	3mm
○	CP302-4	4mm
○	CP302-5	5mm
○	CP302-6	6mm
○	CP302-8	8mm

Maltz



170mm
CP301-1

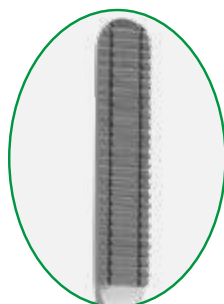

Maltz

CP301-1

8x35mm - downstroke

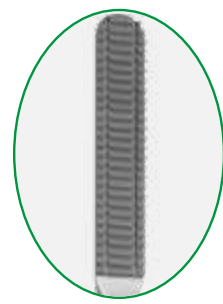

Maltz

CP301

10x45mm - downstroke

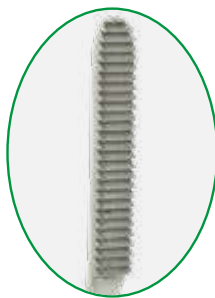

170mm

CP905

8x35mm, concave

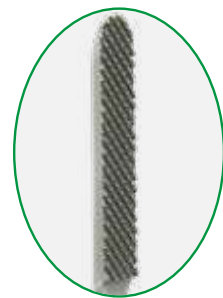

170mm

CP828

8x35mm - downstroke



170mm

CP978

8x35mm, straight, coarse

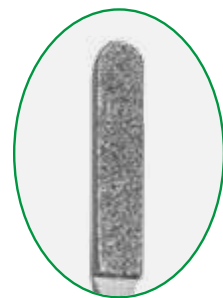

180mm

CP810

8x30mm, straight diamond

Aufricht



200mm
CP1100
8x8mm

200mm



CP973
8x25mm
downward
cutting



CP974
8x25mm
upward cutting

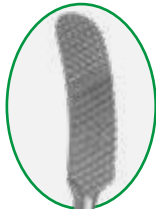

CP976
8x30mm
bi-directional
cutting



200mm
CP291
4x15mm

Bigot



190mm
CP998-1
8x12mm
cross cutting

Fomon



180mm
CP301-2
8x30mm
downward cutting

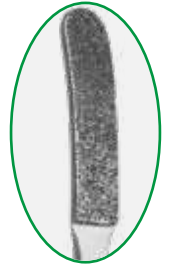

180mm
CP809
8x30mm
diamond

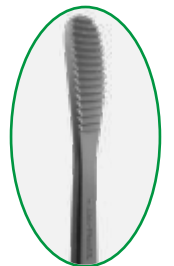

175mm
CP301-3
7x20mm
concave
downward
cutting

Becker

Becker

Fomon

Rees

Gorney

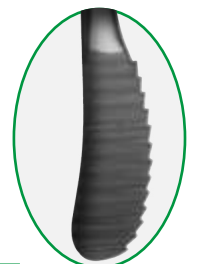
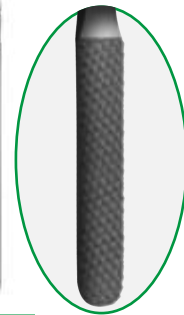

CP301-10
7x38mm-7/8
Sure-Grip™
tungsten

CP1104
7x20mm-1/2
Sure-Grip™
tungsten

CP1105
7x20mm-3/4
Sure-Grip™
tungsten

CP301-4
7x38mm
coarse

CP301-5
7x38mm
coarse

CP301-9
7x12mm
8x22mm

Fomon



210mm

Double-ended
one convex
one flat
coarse teeth

3714149 7mm

fine teeth

3714148 7mm

3714149

Aquaplast™

Scale 1/2

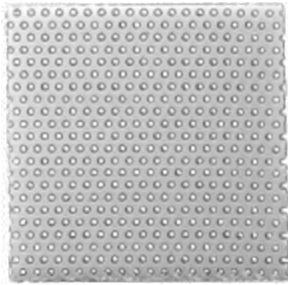

AQ1728^(D)

75x75mm - Pack 10
not sterile, single use

Cartilage template



CP1109

80x90mm
with graduations

^(D) Distributed by Integra MicroFrance SAS (France)
For corresponding manufacturer part numbers, see table in annex.

Cartilage crushing press

Just



CP814-1

delivered with key CP814-3



CP814-2

Smooth plate
30x50mm
for CP814-1



CP814-3

Tightening key
for CP814-1

Perforator bone forceps



Stoll



150mm

CP640

Beyer



CP380

160mm

CP380	CP380-2
straight jaws 2mm	curved jaws 2mm

Beyer



CP380-3

180mm

CP380-3	CP380-5	CP380-1
curved jaws 2mm	curved jaws 4mm	straight jaws 2mm

Jansen-Middleton



180mm

Angled double-action
rongeur

CP621 4x20mm

Double-action bone rongeur

Scale 2/3



Ruskin

160mm

CP381

Martin



240mm

7765

delivered with 2 jaws

Streiff



CP16-1

105mm

CP16-1

CP16

curved blades

straight blades

Scale 3/4



100mm

CP353

strong curvature

Offret



100mm

CP356

Joseph



CP354A

120mm

CP354A

CP354

curved blades

straight blades

Joseph



CP919A

110mm

CP919A

CP919

curved blades

straight blades

Fox



CP358A

110mm

CP358A

CP358

curved blades

straight blades

Kilner-jost



120mm

CP362

curved

Boetcher



180mm

CP997

curved

Brophy



CP367-1

150mm

CP367-1

curved

CP367

straight

Joseph



CP355A

150mm

CP355A

curved

CP355

straight

Bregeat

Matt finish



110mm

CP363

curved blades

Stevens

Matt finish



110mm

CP922

straight blades

Stevens

Matt finish



110mm

CP922A

curved blades

Stevens

Matt finish



115mm - Tenotomy scissors

CP922B

curved blades

Shea

Matt finish



120mm

CP637

curved blades

Reynolds

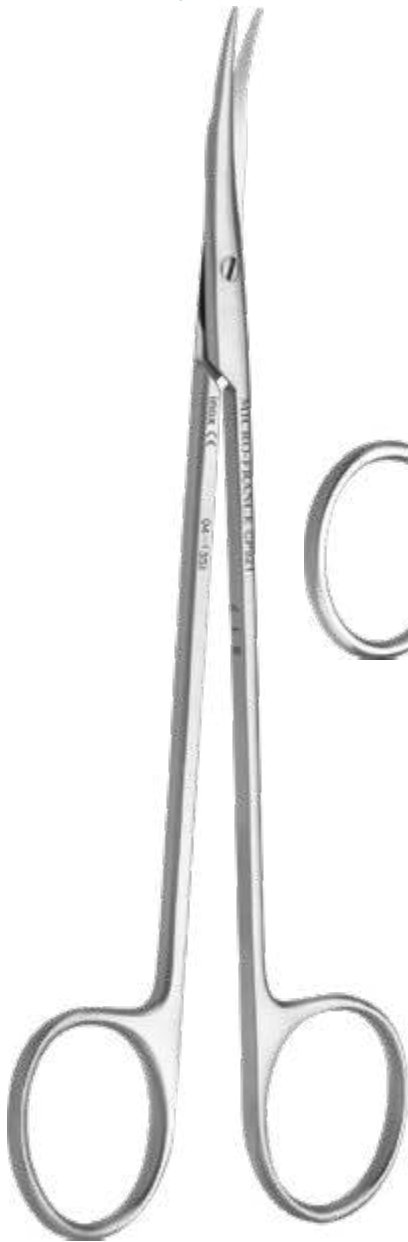

160mm

CP921

Ragnell



150mm

CP616-15

130mm

CP616-13

Joseph



150mm

CP355C

Léger



150mm

CP365



CP351-7

110mm

CP351-7	CP351-6
curved blades	straight blades



CP351-5



CP931-5

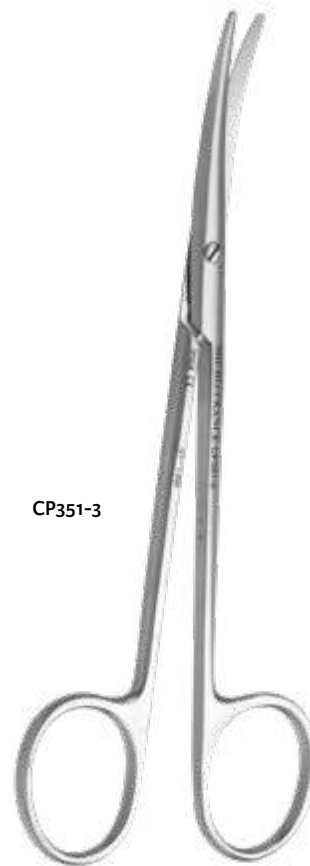

CP351-3

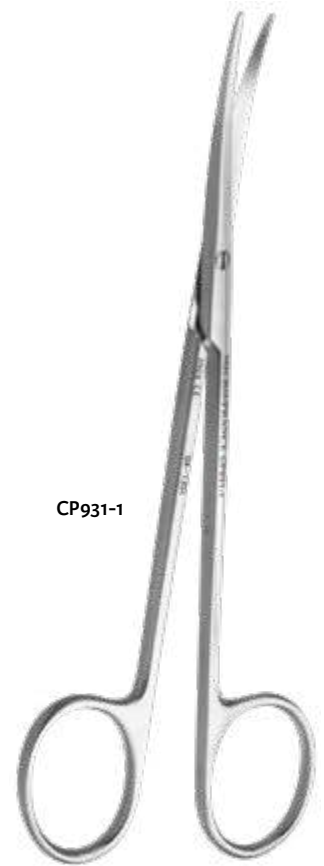

CP931-1

curved standard	
CP351-5	CP351-1
200mm	180mm

curved, delicate	
CP931-5	CP931-3
200mm	180mm

150mm	
CP351-3	CP351-2
curved blades	straight blades

150mm - fine blades	
CP931-1	CP931
curved	straight

matt finish



Becker-Converse

100mm

CP1106

serrated blades



Converse

100mm

CP348



Fomon

140mm

CP612

very curved



Fomon

140mm

CP613

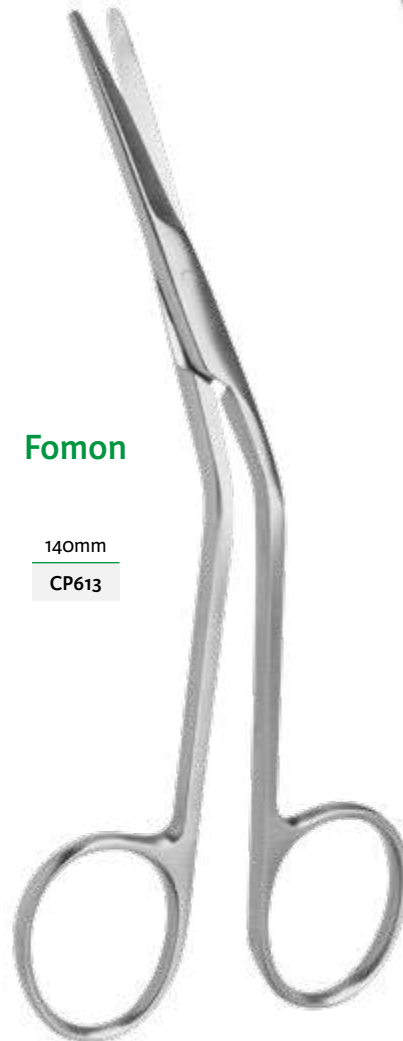

Cottle-Pech

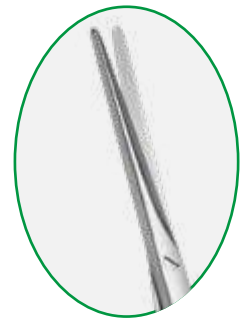

140mm

CP635

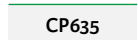

Cottle

150mm

CP614



Pellegrini

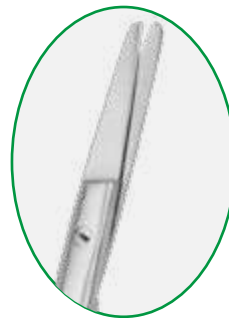

150mm

CP359

serrated blades
dorsal scissors



180mm

CP350

straight scissors
serrated bayonet
blades

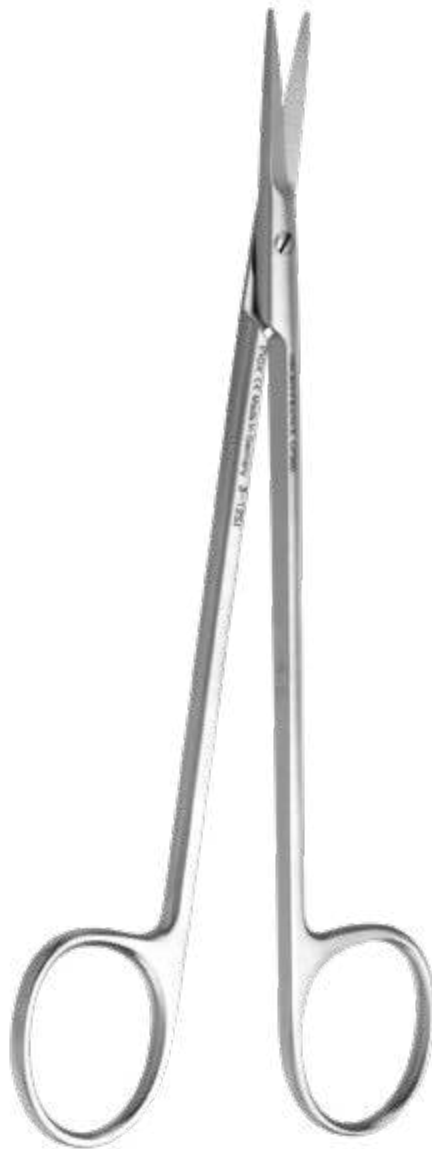

150mm

CP360

straight scissors
serrated blades



120mm

713T

Wire cutting dural scissors
tungsten notched blades

Bebee





Heymann-Klossek

170mm

CP615-1

straight

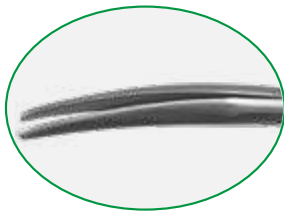

170mm

CP615-2

curved left

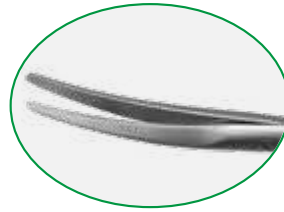

170mm

CP615-3

curved right

Dissecting forceps 110mm



Castroviejo

CP938-1

Horizontal teeth and platform

Castroviejo

CP37

Oblique teeth and platform

CP332

Serrated jaws 1.4mm

Dissecting forceps 120mm

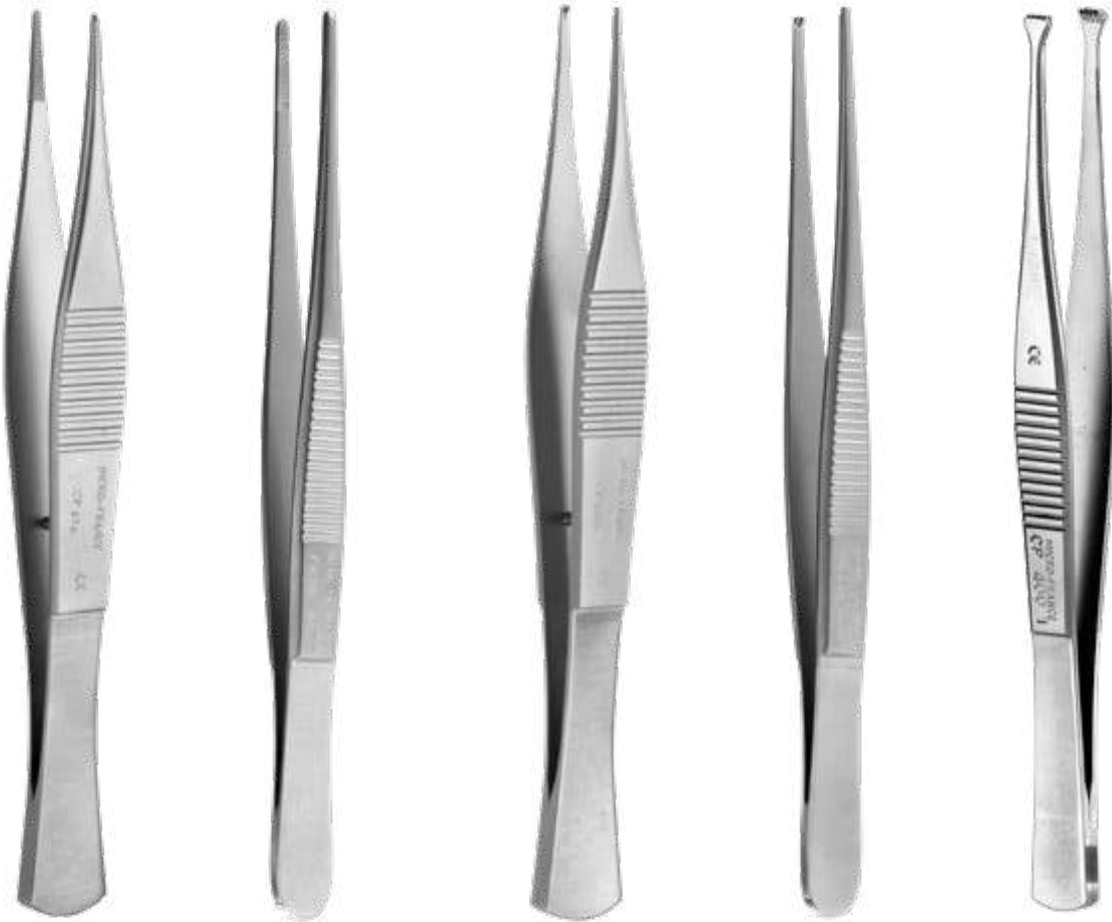

serrated jaws

CP414

Jaws 1mm

7831A-12

Jaws 1.5mm

jaws with teeth

CP406

Jaws 1mm

7833A-12

Jaws 1.5mm

CP400-1

5x5 teeth

150mm

Adson



- CP604-15 serrated jaws 1.5mm
- CP605-15 1x2 teeth jaws 1.5mm

Adson-Brown



- CP606-15 7x7 teeth

120mm



Adson-Tubiana Jaws 1mm Adson Jaws 1.5mm Adson-Brown Jaws 1.5mm Adson-Brown Jaws with 7x7 teeth

M832	M833	CP604	CP605	CP606A	CP606
serrated	1x2 teeth	serrated	1x2 teeth	tungsten serrated jaws	

120mm



Adson-Tubiana

M801

jaws 1x2 teeth and smooth platform

Mac-Indoe

140mm



CP934

oblique teeth and serrated platform

CP934-1

serrated jaws

Debakey

Barraya

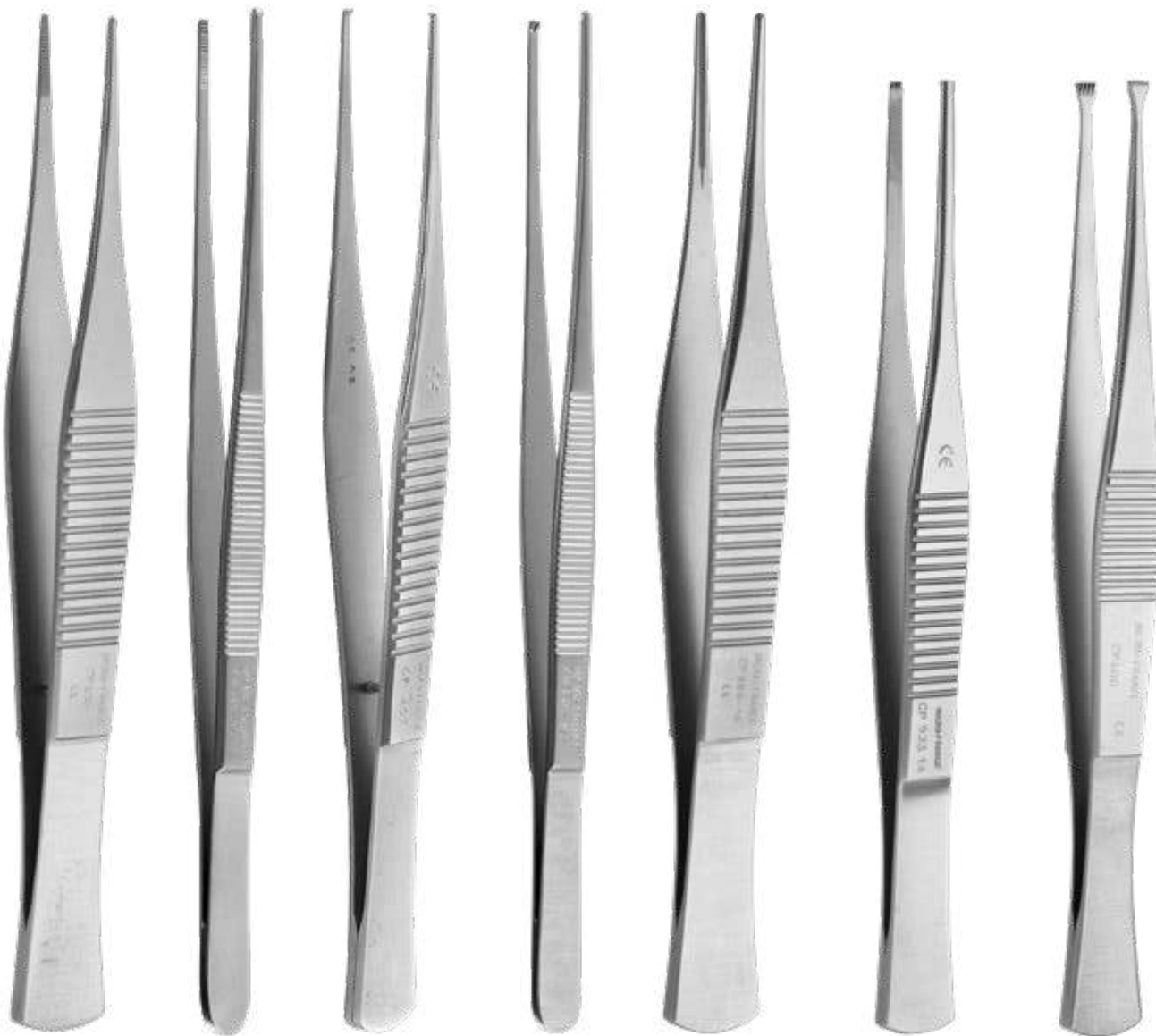

150mm

140mm

CP415	7831A-15	CP407	7833A-15	CP988-15	CP933-14	CP400
serrated jaws 1mm	serrated jaws 1.5mm	1x2teeth jaws 1mm	1x2teeth jaws 1.5mm	Jaws 1.5mm	3x4 teeth and serrated platform	5x5 teeth

Précelle



150mm

CP345

serrated angled jaws

Barraya



160mm

CP933-16

3x4 teeth and
serrated platform

Claoué



160mm

CP401

5x6 teeth

Mac-Indoe



170mm

CP936

1x2 teeth and
serrated platform

Debaquey

Potts-Smith

Barraya



1.5mm

7831A-18



1.5mm

CP988-18



1mm

CP409

1x2 teeth



1.5mm

7833A-18

1x2 teeth



1.5mm

CP933-18

3x4 teeth and
serrated platform



6x6

CP400-2

Debaquey



200mm	210mm
7832	7834
1mm serrated jaws	1mm 1x2 teeth



2mm
7831A-20



1.5mm
CP988-20



2mm
7833A-20
1x2 teeth

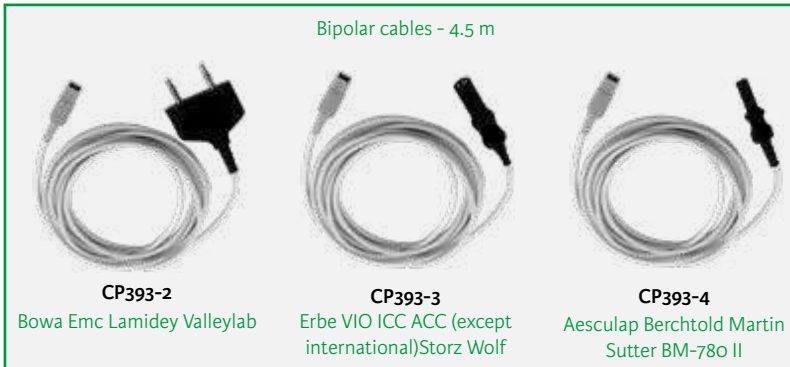

Magnan



Adson



110mm		120mm			160mm		200mm	
CP392-1R	CP604BR	CP605BR	CP392-2R	CP392-8R	CP392BI	CP392BS		
smooth Jaws 1x8mm	serrated jaws 1.5mm	Jaws with teeth 1.5mm	smooth Jaws 1x8mm	smooth Jaws 1x8mm	smooth Jaws 0.5x5mm	smooth Jaws 0.5x5mm		



Bipolar cables - 4.5 m



CP393-2
Bowa Emc Lamidey Valleylab



CP393-3
Erbe VIO ICC ACC
(except international)
Storz Wolf



CP393-4
Aesculap Berchtold Martin
Sutter BM-78o II

CP392-3R	CP392-10R	CP392-5R	CP392-9R
straight smooth Jaws 1x8mm	angled smooth Jaws 1x8mm	bayonet smooth Jaws 1x8mm	bayonet smooth Jaws 1x8mm

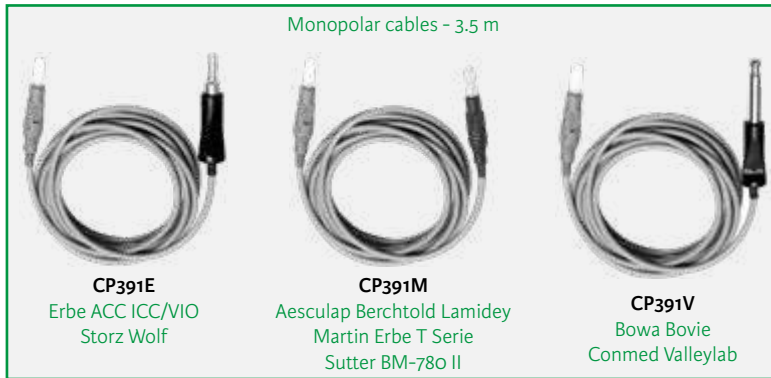

Adson



110mm

CP390-1

Smooth jaws
1x8mm



120mm

CP604M

Serrated jaws
1.5mm



CP605M

Jaws with teeth
1.5mm



160mm

CP390-2

Smooth jaws
1x8mm



CP390-8

Jaws with teeth
1x8mm

Scale 2/3

Working length - «L»

Chambon



290mm L 260mm

CP390L26

Smooth jaws
1x8mm



CP390-3

Smooth jaws
1x8mm



230mm L 200mm

CP390-5

Angled jaws
1x8mm



CP390-7

Smooth jaws
1x8mm

Monopolar cables 3.5 m



CP391E

Erbe ACC ICC/VIO
Storz Wolf



CP391M

Aesculap Berchtold Martin
Erbe T Serie Lamidey
Sutter BM-780 II



CP391V

Bowa Bovie Conmed Valleylab



703T

Halsey

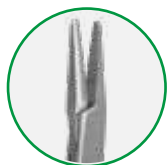

130mm

703T	704T
Serrated jaws	Smooth jaws



702T

Crile-Wood Mayo-Hégar

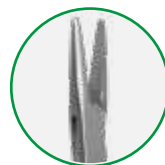

150mm

702T	714T
------	------



Becker



130mm

CP1107

Diamond jaws

Scale 2/3

Crile-Wood

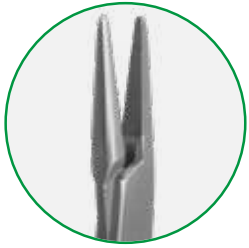

200mm

720T



Crile-Wood

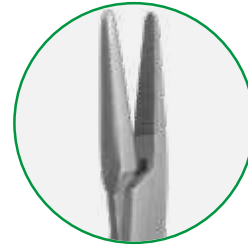

180mm

701T



Stratte



210mm

7945T



Leriche

140mm - without teeth

7867-1	7867-2
straight	curved

140mm - with teeth

7867-3	7867-4
straight	curved



7867-1

Halsted

120mm - with teeth

P761-7	P761-8
straight	curved

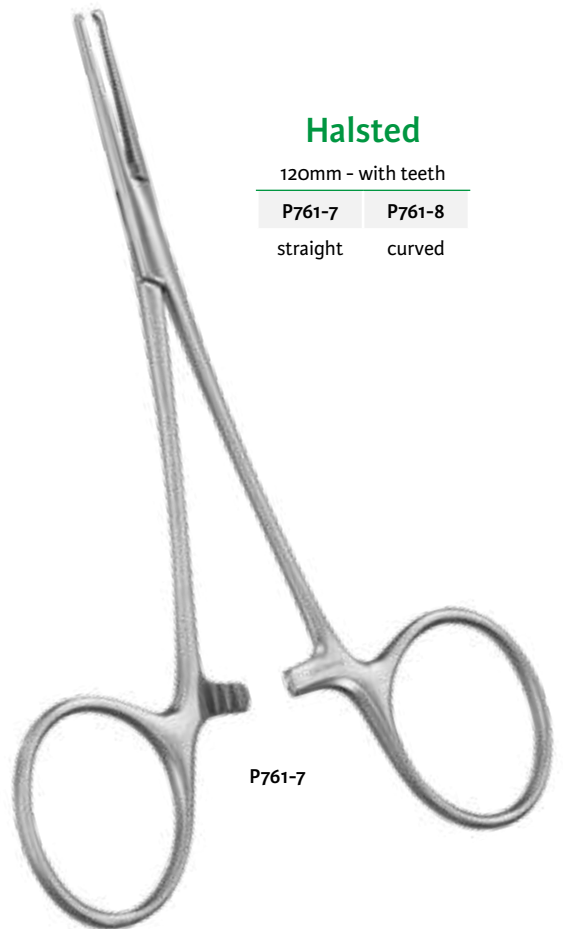

P761-7



Kelly

Without teeth

140mm	160mm
-------	-------

P762-2	P762-4
--------	--------

curved	curved
--------	--------

P762-2

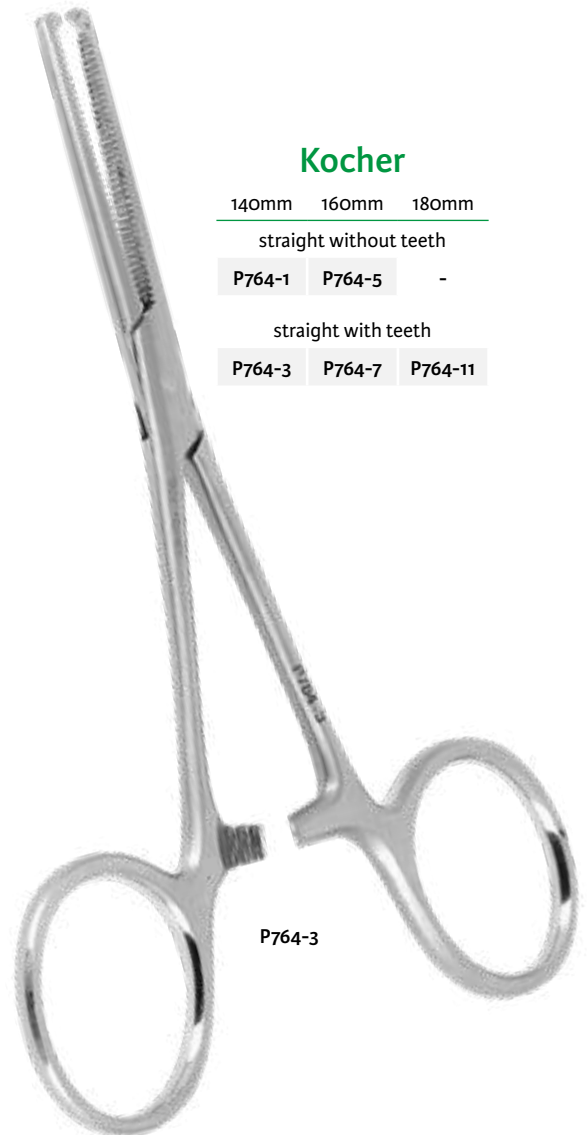

Kocher

140mm	160mm	180mm
-------	-------	-------

straight without teeth

P764-1	P764-5	-
--------	--------	---

straight with teeth

P764-3	P764-7	P764-11
--------	--------	---------

P764-3



Martel

130mm

P763

Forceps with teeth,
«T» tip



Péan

140mm 160mm

P765-14 P765-16

Haemostatic forceps
serrated jaws

P765-14



Terrier

130mm

P769

Haemostatic forceps
serrated jaws

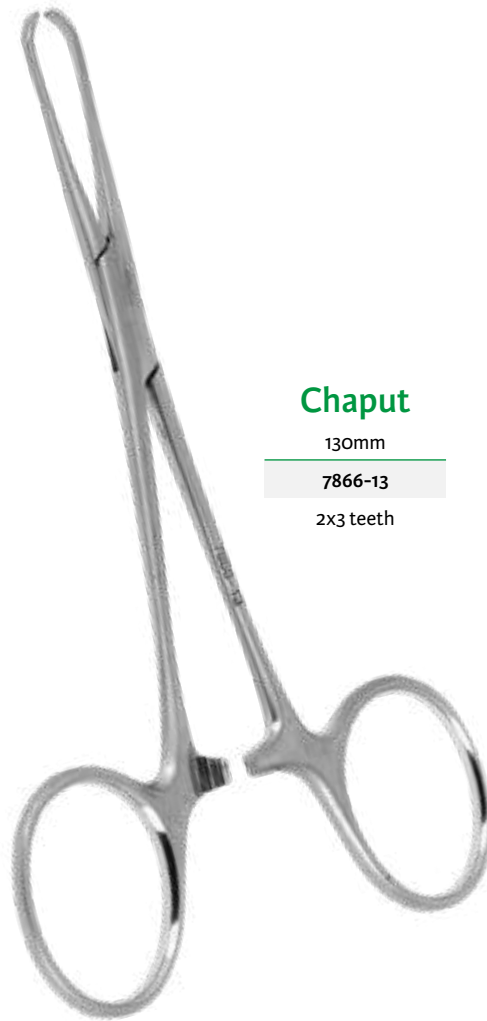

Chaput

130mm

7866-13

2x3 teeth

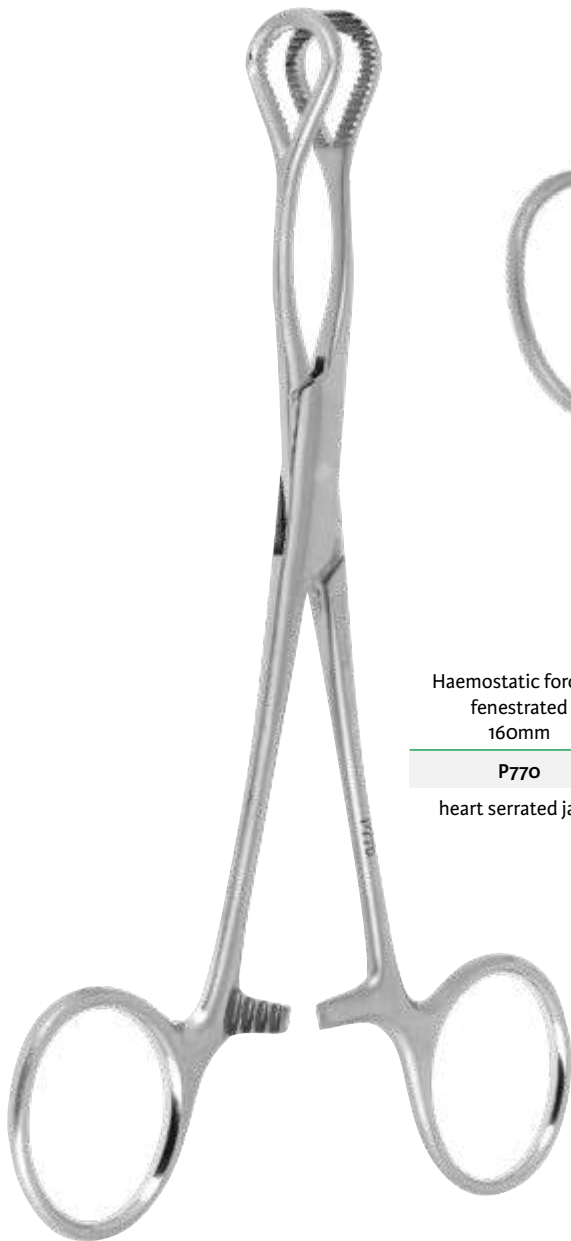

Haemostatic forceps
fenestrated
160mm

P770

heart serrated jaws



Ombredanne

Forceps with teeth
130mm

P771

Otoabrader rasps



CP85L



Stenstrom

160mm - 2x8mm

CP85L	CP85R
curved left	curved right



CP85R

Elevators



CP85AL



Stenstrom

160mm - 2x8mm

CP85AL	CP85AR
curved left	curved right



CP85AR

Working length «L»

Micro Irrigation tube



MCM10-0-5 Ø 0.5mm L 30mm
MCM10-1-0 Ø 1.0mm

Micro vascular clamp - L 13mm

Gilbert O'Brien

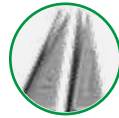

medium

MCM13

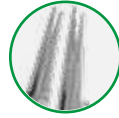

small

MCM13-1

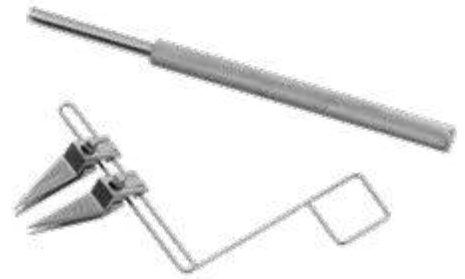

MCM13

Micro dissecting forceps - 150mm



MCM4BISR



MCM4BISR

Jaws with teeth and platform

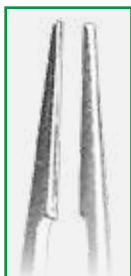

MCM4R

Smooth jaws with plate

Jewelers forceps



130mm

MCM973D3 n°3

MCM973D5 n°5

Micro scissors

Vanas



MCM7BISR

8mm
Blunt curved

Vanas



MCM7R

8mm
straight serrated jaws



MCM970

8mm
Atraumatic curved



MCM7BISR
150mm

Micro needle-holder

O'Brien



MCM12R

5x0.3mm
Smooth jaws curved



MCM12R
150mm

Barraquer-Comtet



MCM1R

8mm
Smooth jaws straight



MCM25-3

210x130mm

Scale 1/4

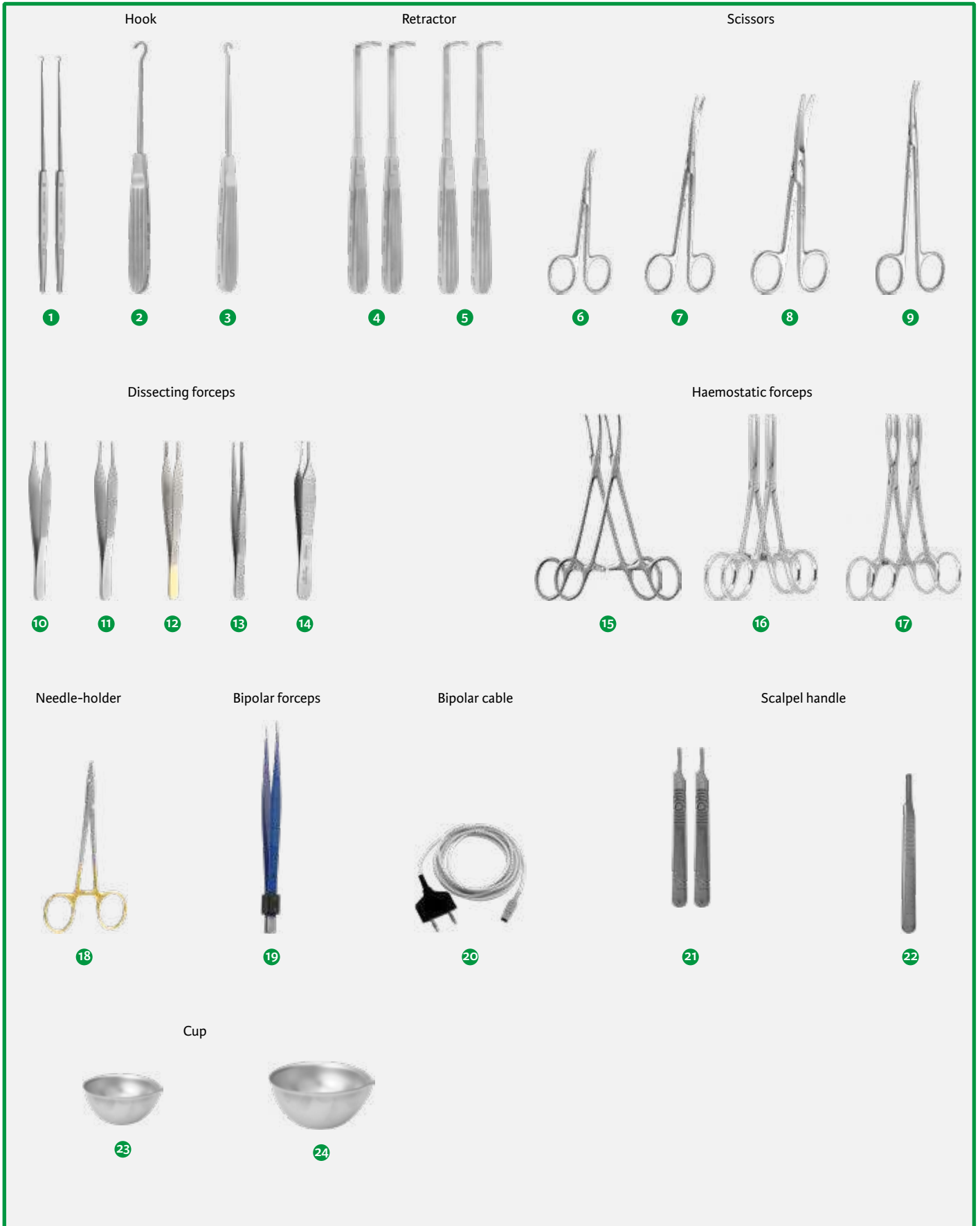

Composition Hand set of Gilbert

N°	Reference	Description	Qt	Detail
1	CP17	Gillies round sharp hook 3mm tip 180mm length	2	page 13
2	M809	Blunt tendon hook, large size, 190mm length	1	see below
3	M809A	Blunt tendon hook, small size, 190mm length	1	see below
4	M806A	Tubiana-Gilbert retractor 10x20mm, 190mm length	2	see below
5	M806E	Tubiana-Gilbert retractor 5x20mm, 190mm length	2	see below
6	CP922A	Stevens curved tenotomy scissors, blunt tip, 110mm length	1	page 38
7	CP931-1	Metzenbaum delicate curved scissors, blunt tip, 150mm length	1	page 40
8	CP352-1	Mayo curved scissors, beveled blades, 150mm length	1	page 41
9	CP921	Reynolds curved scissors, blunt tip, 160mm length	1	page 39
10	M801	Adson-Tubiana delicate forceps, 1x2 teeth and plateform, 120mm length	1	see below
11	M833	Adson-Tubiana dissecting forceps, 1x2 teeth, 1mm jaws, 120mm length	1	see below
12	CP606A	Adson dissecting forceps, serrated tungsten jaws, 1.5mm tip, 120mm length	1	page 47
13	7833A-12	Dissecting forceps, 1x2 teeth, 1.5mm jaws, 120mm length	1	page 46
14	CP605	Adson dissecting forceps, 1x2 teeth, 1.5mm jaws, 120mm length	1	page 47
15	7867-2	Leriché haemostatic forceps, curved jaws without teeth, 140mm length	2	page 60
16	P764-3	Kocher haemostatic forceps, straight jaws with teeth, 140mm length	2	page 61
17	P765-14	Péan haemostatic forceps, serrated jaws, 140mm length	2	page 62
18	703T	Halsey tungsten needle-holder, for needles 4/0 5/0, 130mm length	1	page 57
19	CP392-2R	Bipolar forceps, 1x8mm jaws, 160mm length	1	page 53
20	CP393-2	Bowa Emc Lamidey Valleylab bipolar cable, 4.5m ⁽¹⁾	1	page 53
21	1003IG ^(D)	Scalpel handle, size 3, for 11/15 blades, graduated handle from 0 to 55mm, 120mm length	2	page 09
22	1004IG ^(D)	Scalpel handle, size 4, for 23 blades, graduated handle from 0 to 55mm, 120mm length	1	page 09
23	7876-60 ^(D)	Stainless steel cup with pouring spout, 60mm diameter, 60ml	1	page 82
24	7876-80 ^(D)	Stainless steel cup with pouring spout, 80mm diameter, 100ml	1	page 82

⁽¹⁾ Please contact customer service for a bipolar cable compatible with a different generator from those mentioned

Scale 1/2



M809

Tendon hook 190mm

M809	M809A
large	small

Tubiana-Gilbert



M806A

Blunt retractor 190mm

M806A	M806E
10x20mm	5x20mm



M801

Adson-Tubiana

Delicate forceps 120mm

M801	M833
1x2 teeth and plateform	1x2 teeth jaws 1mm

^(D) Distributed by Integra MicroFrance SAS (France) - For corresponding manufacturer part numbers, see table in annex

Scale 1/2



Composition Bone set of Gilbert

N°	Reference	Description	Qt	Page
1	M821A	Graft remover Ø2mm 100mm length	1	see below
2	M821B	Graft remover Ø4mm 100mm length	1	
3	M821C	Graft remover Ø6mm 100mm length	1	
4	M823A	Square pick 1mm tip, 165mm length	1	see below
5	M823B	Square pick 2mm tip, 165mm length	1	
6	M823C	Square pick 3mm tip, 165mm length	1	
7	M823D	Square pick 4mm tip, 165mm length	1	
8	M823E	Square pick 5mm tip, 165mm length	1	
9	M813C	Curved raspatory 2mm, 160mm length	1	see below
10	M813B	Curved raspatory 3mm, 160mm length	1	
11	M813A	Curved raspatory 4mm, 160mm length	1	
12	M815B	Curved raspatory square 3mm tip, 150mm length	1	see below
13	M815A	Curved raspatory square 4mm tip, 150mm length	1	
14	CP302-2	Volkman curette, straight, 2mm, 170mm length	1	page 26
15	CP302-3	Volkman curette, straight, 3mm, 170mm length	1	
16	CP958	Trélat curved elevator, 5mm, 170mm length	1	page 74
17	CP304-2	Marchac Straight osteotome 2mm, 185mm length	1	page 22
18	CP304-3	Marchac Straight osteotome 3mm, 185mm length	1	
19	CP304-5	Marchac Straight osteotome 5mm, 185mm length	1	
20	CP304-7	Marchac Straight osteotome 7mm, 185mm length	1	
21	CP304-9	Marchac Straight osteotome 9mm, 185mm length	1	
22	CP304-11	Marchac Straight osteotome 11mm, 185mm length	1	
23	CP907	Round mallet, 1 teflon head, 200g, 180mm length	1	page 19
24	CP380-3	Beyer double-action rongeur, curved 2mm jaws, 180mm length	1	page 32
25	CP392-2R	Bipolar forceps, 1x8mm jaws, 160mm length	1	page 53
26	CP393-2	Bowa Emc Lamidey Valleylab bipolar cable, 4.5m ⁽¹⁾	1	

⁽¹⁾ Please contact customer service for a bipolar cable compatible with a different generator from those mentioned

Scale 1/2



M815A

Curved raspatory square tip 160mm

M815A	M815B
4mm	3mm



M813B

Curved raspatory 150mm

M813A	M813B	M813C
4mm	3mm	2mm



M823C

Square pick 165mm

M823A	M823B	M823C	M823D	M823E
1mm	2mm	3mm	4mm	5mm



M821B

Graft remover 100mm

M821A	M821B	M821C
Ø2mm	Ø4mm	Ø6mm

Scale 1/2

Masson

7809MF

140mm



Doyen

7821B

120mm

7821A

140mm



7821B

7805-11



Seemann-Seiffert

7805-11

110mm

7805-13

130mm

Jennings

7804-9 90mm

7804-11 110mm

7804-13 130mm

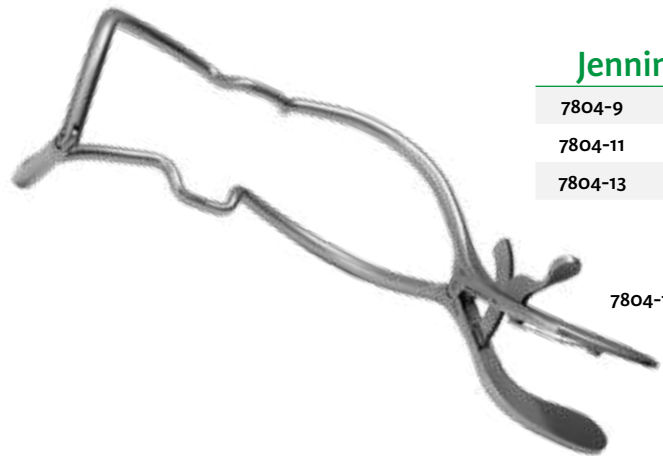

7804-13

Malleable



210mm
CP818-8



8mm 10mm 12mm 15mm 20mm

CP818-8 CP818-10 CP818-12 CP818-15 CP818-20

Dautrey



15x40mm

15x55mm

140mm
CP984

Dautrey



15x60mm

15x85mm

140mm
CP984-1

Malleable



10mm

15mm

Malleable blade retractor
10/15mm - 160mm

7773

Ginestet

260mm

CP986

Sharp hook



Lindemann

Drill burr



164RS-1-8^(D)

45mm shaft 33mm

168RS^(D)

70mm shaft 45mm

^(D) Distributed by Integra MicroFrance SAS (France) - For corresponding manufacturer part numbers, see table in annex

Tessier

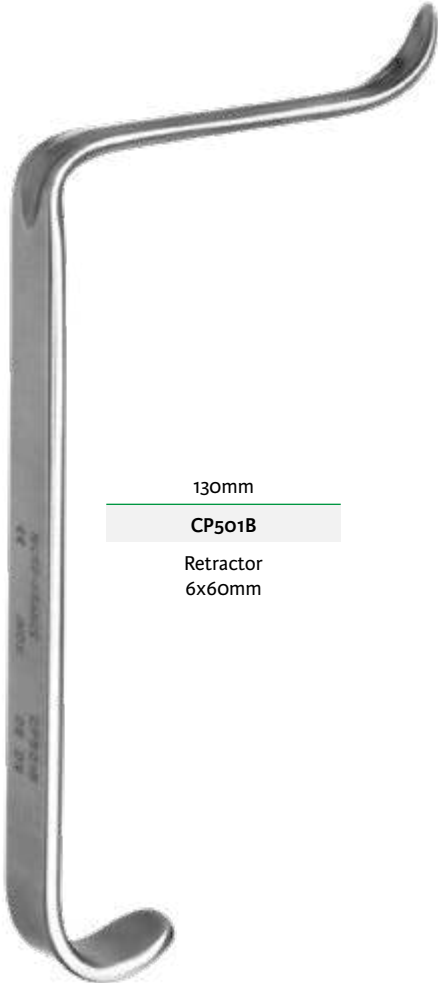

130mm

CP501B

Retractor
6x60mm



180mm

CP521

Spreader

Obwegeser

145mm

CP522

curved wire pass



Kawamoto

Veau

Trélat



curved osteotome
175mm

sharp hook 90°
165mm

curved elevator
170mm

curved raspatory
170mm

CP324

CP956

CP957

CP958

CP959

CP960

10mm

8mm

6mm

5mm

3mm

4mm

Tessier



120mm

CP364

curved



160mm

CP914

curved



160mm

CP357-1

curved



200mm

CP357-2

curved

Trepsat



200mm

CP369-2



CP369-1

straight

5.5mm



CP369-2

straight

8.5mm



CP369-3

straight

13mm

Facelift forceps with teeth

Assumpção

Pitanguy

Servant



180mm

CP829T

with ratchet

160mm

CP830

150mm

CP994

Forceps with teeth

Facelift retractor

Freeman

Facelift blunt retractor



190mm

Freeman

Facelift shapr retractor 4 prongs



180mm



CP819-12	CP819-15	CP826	CP826-1
85x12mm	85x15mm	35mm	20mm

Spatulated elevator



Scale 1/3

Working length «L»

Slamia

320mm - L 200mm

CP845

Breast areola marker

Breast areola marker - Ø 38/42mm

Scale 1/1



CP961

double serrated



CP961-1

double sharp

Breast areola marker

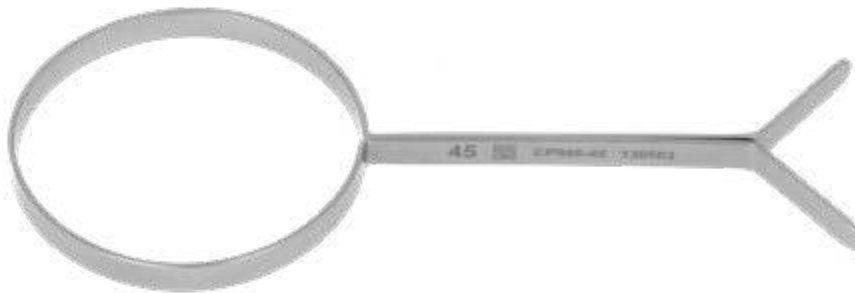

CP980-45

Dufourmental

CP980-35	Ø 35mm
CP980-40	Ø 40mm
CP980-45	Ø 45mm
CP980-50	Ø 50mm
CP980-55	Ø 55mm

Scale 1/3

Breast curved elevator

Agris-Dingmann

370mm - L 250mm



left

CP991L

right

CP991R

Breast tensor

Mole

290mm



CP981

Picture for information, without scale



Cup	
7876-60 ^(D)	60mm
7876-80 ^(D)	80mm
7876-100 ^(D)	100mm
7876-120 ^(D)	120mm
7876-160 ^(D)	160mm



Tray	
7872-24 ^(D)	240x180mm



MCO731^(D)
Surgical instrument oil

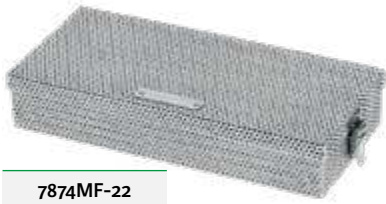

7874MF-22
220x100x40mm

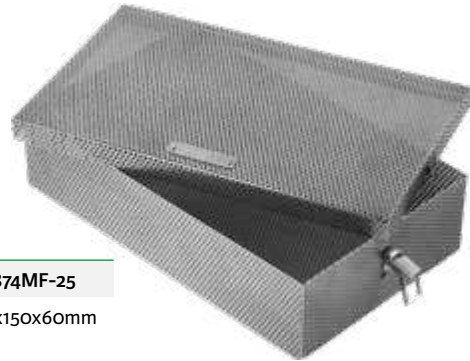

7874MF-25
250x150x60mm

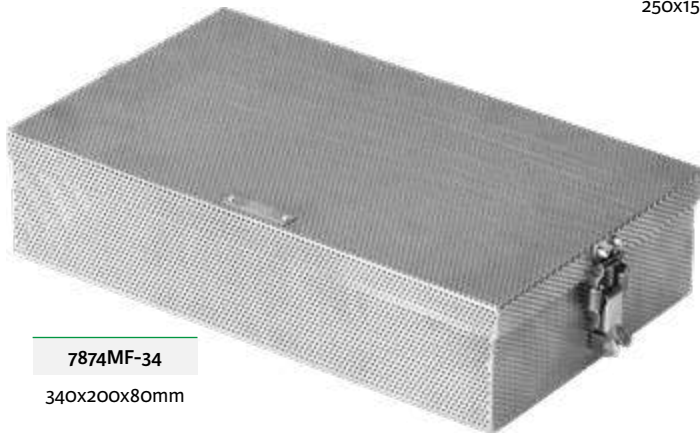

7874MF-34
340x200x80mm

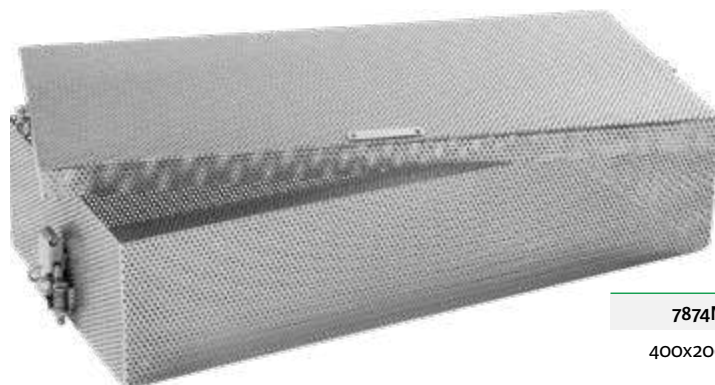

7874MF-40
400x200x90mm

^(D) Distributed by Integra MicroFrance SAS (France) - For corresponding manufacturer part numbers, see table in annex

Numerical index

1

164RS-1-8(D)	73
168RS(D)	73
1003IG(D)	9, 68
1003LI(D)	9
1004IG(D)	9, 68
1005I(D)	9

3

3714024	14
3714025	14
3714026	14
3714027	15
3714028	15
3714055	21
3714056	21
3714057	21
3714058	21
3714096	26
3714098	23
3714099	23
3714107	14
3714108	14
3714109	14
3714111	14
3714148	30
3714149	30
3714164	10
3714166	10
3714182	17
3714183	17
3714187	17
3714320	21
3714364	14
3714678	10
3724059	11
3724256	14

7

701T	59
702T	57
703T	57, 68
704T	57
713T	44
714T	57
720T	59
7726MF	3
7727	3
7728	3

7732-1	3
7733	3
7734	3
7765	35
7766	19
7768	13
7768-1	13
7773	72
7779MF-1	4
7779MF-2	4
7779MF-3	4
7779MF-5CC	4
7782-1-2	15
7783-12	4
7787-10	11
7804-9	71
7804-11	71
7804-13	71
7805-11	71
7805-13	71
7809MF	71
7821A	71
7821B	71
7831A-12	46
7831A-15	49
7831A-18	51
7831A-20	52
7832	52
7833A-12	46, 68
7833A-15	49
7833A-18	51
7833A-20	52
7834	52
7866-13	63
7867-1	60
7867-2	60, 68
7867-3	60
7867-4	60
7872-24(D)	82
7874MF-22	82
7874MF-25	82
7874MF-34	82
7874MF-40	82
7876-60(D)	68, 82
7876-80(D)	68, 82
7876-100(D)	82
7876-120(D)	82
7876-160(D)	82
7903-50-5(D)	4
7945T	59

A

AQ1728(D)	31
-----------------	----

CP

CP16	36
CP16-1	36
CP17	13, 68
CP17-1	13
CP17-2	13
CP17-3	13
CP21-3	15
CP21A-3	15
CP23-4	17
CP23-6	17
CP23-8	17
CP23-10	17
CP23A-8	17
CP37	46
CP85AL	64
CP85AR	64
CP85L	64
CP85R	64
CP291	28
CP300	19
CP301	27
CP301-1	27
CP301-2	28
CP301-3	28
CP301-4	29
CP301-5	29
CP301-9	29
CP301-10	29
CP302-2	26, 70
CP302-3	26, 70
CP302-4	26
CP302-5	26
CP302-6	26
CP302-8	26
CP304-2	22, 70
CP304-3	22, 70
CP304-4	22
CP304-5	22, 70
CP304-6	22
CP304-7	22, 70
CP304-8	22
CP304-9	22, 70
CP304-10	22
CP304-11	22, 70
CP304-12	22
CP304-14	22

^(D) Distributed by Integra MicroFrance SAS (France) - For corresponding manufacturer part numbers, see table in annex

CP304-15.....	22	CP344DT.....	12	CP391M.....	55, 56
CP304-16.....	22	CP344E.....	12	CP391V.....	55, 56
CP304B-2.....	22	CP344ET.....	12	CP392-1R.....	53
CP304B-3.....	22	CP345.....	50	CP392-2R.....	53, 68, 70
CP304B-4.....	22	CP348.....	42	CP392-3R.....	54
CP304B-5.....	22	CP350.....	44	CP392-5R.....	54
CP304B-6.....	22	CP351-1.....	40	CP392-8R.....	53
CP304B-8.....	22	CP351-2.....	40	CP392-9R.....	54
CP304B-10.....	22	CP351-3.....	40	CP392-10R.....	54
CP304B-12.....	22	CP351-5.....	40	CP392BI.....	53
CP305.....	23	CP351-6.....	40	CP392BS.....	53
CP305L.....	23	CP351-7.....	40	CP393-2.....	53, 54, 68, 70
CP305R.....	23	CP352.....	41	CP393-3.....	53, 54
CP306.....	17	CP352-1.....	41, 68	CP393-4.....	53, 54
CP309-8-12.....	24	CP352-2.....	41	CP400.....	49
CP309-10-14.....	24	CP352-3.....	41	CP400-1.....	46
CP309-12-16.....	24	CP353.....	36	CP400-2.....	51
CP309-14-16.....	24	CP354.....	36	CP401.....	50
CP309-14-18.....	24	CP354A.....	36	CP406.....	46
CP310.....	12	CP355.....	37	CP407.....	49
CP310D.....	12	CP355A.....	37	CP409.....	51
CP310E.....	12	CP355C.....	39	CP414.....	46
CP313.....	25	CP356.....	36	CP415.....	49
CP313-1.....	25	CP357-1.....	76	CP501B.....	73
CP314-14.....	24	CP357-2.....	76	CP521.....	73
CP315.....	23	CP358.....	36	CP522.....	74
CP315D.....	23	CP358A.....	36	CP604.....	47
CP315G.....	23	CP359.....	43	CP604-15.....	47
CP316.....	23	CP360.....	44	CP604BR.....	53
CP317.....	22	CP362.....	37	CP604M.....	55
CP318.....	22	CP363.....	38	CP605.....	47, 68
CP324.....	74	CP364.....	75	CP605-15.....	47
CP330-3-0.....	8	CP365.....	39	CP605BR.....	53
CP330-4-0.....	8	CP367.....	37	CP605M.....	55
CP331.....	16	CP367-1.....	37	CP606.....	47
CP331-1.....	16	CP369-1.....	77	CP606-15.....	47
CP332.....	46	CP369-2.....	77	CP606A.....	47, 68
CP333.....	10	CP369-3.....	77	CP609.....	15
CP335.....	15	CP380.....	32	CP611.....	5
CP337.....	7	CP380-1.....	32	CP612.....	42
CP337-1.....	7	CP380-2.....	32	CP613.....	42
CP338.....	16	CP380-3.....	32, 70	CP614.....	43
CP339.....	16	CP380-5.....	32	CP615-1.....	45
CP340.....	16	CP381.....	34	CP615-2.....	45
CP341.....	16	CP390-1.....	55	CP615-3.....	45
CP344A.....	12	CP390-2.....	55	CP616-13.....	39
CP344AT.....	12	CP390-3.....	56	CP616-15.....	39
CP344B.....	12	CP390-5.....	56	CP621.....	33
CP344BT.....	12	CP390-7.....	56	CP622-4.....	10
CP344C.....	12	CP390-8.....	55	CP624-45.....	2
CP344CT.....	12	CP390L26.....	56	CP624-55.....	2
CP344D.....	12	CP391E.....	55, 56	CP624-65.....	2

^(D) Distributed by Integra MicroFrance SAS (France) - For corresponding manufacturer part numbers, see table in annex

CP624-75.....	2	CP931.....	40	CP1109.....	31
CP624LF-75.....	2	CP931-1.....	40, 68		
CP625.....	5	CP931-3.....	40		
CP626.....	6	CP931-5.....	40		
CP627.....	6	CP933-14.....	49		
CP628.....	13	CP933-16.....	50		
CP630.....	18	CP933-18.....	51		
CP632.....	18	CP934.....	49		
CP635.....	42	CP934-1.....	49		
CP637.....	38	CP936.....	50		
CP640.....	31	CP938-1.....	46		
CP801-7.....	20	CP941.....	13		
CP801-10.....	20	CP947.....	18		
CP802.....	23	CP949-45.....	2		
CP803.....	16	CP949-55.....	2		
CP806.....	25	CP949-75.....	2		
CP807.....	25	CP956.....	74		
CP808-6.....	25	CP957.....	74		
CP809.....	28	CP958.....	70, 74		
CP810.....	27	CP959.....	74		
CP814-1.....	31	CP960.....	74		
CP814-2.....	31	CP961.....	80		
CP814-3.....	31	CP961-1.....	80		
CP818-8.....	72	CP973.....	28		
CP818-10.....	72	CP974.....	28		
CP818-12.....	72	CP976.....	28		
CP818-15.....	72	CP978.....	27		
CP818-20.....	72	CP980-35.....	80		
CP819-12.....	79	CP980-40.....	80		
CP819-15.....	79	CP980-45.....	80		
CP821.....	9	CP980-50.....	80		
CP822-10.....	13	CP980-55.....	80		
CP822-12.....	13	CP981.....	81		
CP822-14.....	13	CP984.....	72		
CP823-5.....	21	CP984-1.....	72		
CP824-5.....	21	CP985.....	5		
CP825.....	11	CP986.....	73		
CP826.....	79	CP988-15.....	49		
CP826-1.....	79	CP988-18.....	51		
CP828.....	27	CP988-20.....	52		
CP829T.....	78	CP991L.....	81		
CP830.....	78	CP991R.....	81		
CP845.....	80	CP994.....	78		
CP905.....	27	CP997.....	37		
CP907.....	19, 70	CP998-1.....	28		
CP914.....	75	CP1100.....	28		
CP919.....	36	CP1102.....	7		
CP919A.....	36	CP1103.....	7		
CP921.....	39, 68	CP1104.....	29		
CP922.....	38	CP1105.....	29		
CP922A.....	38, 68	CP1106.....	42		
CP922B.....	38	CP1107.....	58		

M	
M801.....	48, 68
M806A.....	68
M806E.....	68
M809.....	68
M809A.....	68
M812A.....	13
M813A.....	70
M813B.....	70
M813C.....	70
M815A.....	70
M815B.....	70
M821A.....	70
M821B.....	70
M821C.....	70
M823A.....	70
M823B.....	70
M823C.....	70
M823D.....	70
M823E.....	70
M832.....	47
M833.....	47, 68

MCEN	
MCEN2.....	2
MCEN770J30.....	8
MCEN770J40.....	8

MCL	
MCL38N(D).....	2
MCL75.....	2
MCL170(D)(1).....	2
MCL171(D)(1).....	2
MCL173(D)(1).....	2
MCL174(D)(1).....	2
MCL197(D)(1).....	2

MCM	
MCM1R.....	66
MCM4BISR.....	65
MCM4R.....	65
MCM7BISR.....	66
MCM7R.....	66
MCM10-0-5.....	65
MCM10-1-0.....	65
MCM12R.....	66

MCM13	65
MCM13-1	65
MCM25-3	66
MCM970	66
MCM973D3	65
MCM973D5	65

S

SCP337A	7
---------------	---

MCO

MCO201-2-5	8
MCO201-3-0	8
MCO214-13-10	20
MCO214-13-20	20
MCO214-13-40	20
MCO214-13-60	20
MCO214-13-80	20
MCO305	5
MCO731(D)	82
MCO770-1-5	8
MCO770-2-0	8
MCO770-2-5	8
MCO770-3-0	8
MCO770-3-5	8
MCO770-4-0	8
MCO771-2-5	8
MCO771-3-0	8
MCO771-4-0	8
MCO803	5
MCO979	11
MCO988	11
MCO995	19

P

P761-7	60
P761-8	60
P762-2	61
P762-4	61
P763	62
P764-1	61
P764-3	61, 68
P764-5	61
P764-7	61
P764-11	61
P765-14	62, 68
P765-16	62
P769	62
P770	63
P771	63

⁽¹⁾ Not a medical device

⁽²⁾ Distributed by Integra MicroFrance SAS (France) - For corresponding manufacturer part numbers, see table in annex

**Table for corresponding
manufacturer part numbers
For information purposes only**

Integra MicroFrance® product reference	Corresponding manufacturer part number
1003IG	M3IG
1003LI	M3LI
1004IG	M4IG
1005I	M5I
164RS-1-8	39164RF104018
168RS	39168RF105023
7872-24	1224
7876-100	310
7876-120	312
7876-160	316
7876-60	306
7876-80	308
7903-50-5	13.202
AQ1728	PS-1728
MCL170 ⁽¹⁾	CO101
MCL171 ⁽¹⁾	CO201
MCL173 ⁽¹⁾	CO100
MCL174 ⁽¹⁾	CO200
MCL197 ⁽¹⁾	CO103
MCL38N	EC-BLU50U090
MCO731	430490

⁽¹⁾ Not a medical device

Integra® MicroFrance®

Integra ENT - Plastic surgery catalogue

Manufacturers :



Integra MicroFrance SAS (France)
Le Pavillon ■ 03160 Saint Aubin le Monial ■ France



Hager & Meisinger GmbH
Hansenmannstrasse 10
D- 41468 Neuss ■ Allemagne



Swann Morton Ltd
Penn Works ■ Owlerton Green ■ Sheffield
South Yorkshire S6 2BJ ■ Royaume Uni



Unimed SA
Rue du Grand-Pré 10
1007 Lausanne ■ Suisse

Manufacturers with CE class I products only :



Agencinox
Zone Industrielle
89110 Aillant sur Tholon ■ France



Chemische Fabrik Dr. Weigert GmbH & Co.
Mühlenhagen
D-20539 Hamburg ■ Allemagne



Moria S.A.
15, rue Georges Besse
92160 Antony ■ France



Qfix
440 Church Road
Avondale ■ PA 19311 USA



Medical devis & QA Services Ltd
76, Stockport Road ■ Timperley
Cheshire ■ WA15 75N ■ Royaume Uni



Sunoptic Technologies
6018 Bowdendale Avenue
Jacksonville 32216 ■ Florida USA



RMS - UK Limited
28 Trinity Road ■ Nailsea
Somerset BS48 4NU ■ Royaume Uni

Availability of these products might vary from a given country or region to another, as a result of specific local regulatory approval or clearance requirements for sale in such country or region.

- Consult product labels and inserts for any indications, contraindications, hazards, warnings, precautions, and instructions for use.
- Non contractual document. The manufacturer reserves the right, without prior notice, to modify the products in order to improve their quality.
- Warning: Applicable laws restrict these products to sale by or on the order of a physician.

Additional information for EMEA Customers only :

Products mentioned in this document are CE class I, Im, IIa or IIb devices. Contact Integra should you need any additional information on devices classification. All the medical devices mentioned on this document are CE marked according to European council directive 93/42/EEC on medical devices and its relatives. References that are not medical devices are identified with the indication "NOT A MEDICAL DEVICE".

Products marked with the symbol ⁽⁹⁾ are distributed by Integra MicroFrance SAS (France)

Date of last révision : 12/2020

For more information, please contact customer service :

Europe, Middle-East, Africa

International: +33 (0) 437 47 59 50 ■ +33 (0) 437 47 59 25 (Fax) ■ csema@integralife.com
France: +33 (0) 437 47 59 10 ■ +33 (0) 437 47 59 29 (Fax) ■ custservfrance@integralife.com
United Kingdom: +44 (0) 1264 312 725 ■ +44 (0) 1264 312 821 (Fax) ■ custsvcs.uk@integralife.com
Belgium & Luxembourg: +32 (0)2 257 4130 ■ +32 (0)2 253 2466 (Fax) ■ custsvcbenelux@integralife.com
Netherlands: +31(0) 852 083 167 ■ +31(0) 207 093 627 (Fax) ■ custsvcnetherlands@integralife.com
Italy: +39 (0)2 577 8921 ■ +39 (0)2 575 113 71 (Fax) ■ custsvitaly@integralife.com
integralife.eu/contact

Integra and the Integra logo are registered trademarks of Integra LifeSciences Corporation or its subsidiaries in the United States and/or other countries.

MicroFrance is a trademark of Integra LifeSciences Corporation or its subsidiaries.
All other trademarks and product names are the property of their respective owners.

© 2020 Integra LifeSciences Corporation. All rights reserved.

0332887-4-EN

DOCUMENT FOR USE IN EUROPE, MIDDLE-EAST AND AFRICA ONLY.