



Integra[®] MicroFrance[®]

Integra ENT - Nose catalogue

Table of contents	ii	Other Rasps	37
Warranty and Customer Service Information	iv	Nasal splint, cartilage template	38
Indications / Contraindications	v	Crushing press, Perforator bone forceps	39
Diagnosis	2-3	Punch rongeur forceps	40
Air bag	2	Double-action rongeur	41-42
Angled probe caustic holder	3	Double-action bone rongeur	43
Blunt hook	3	Septum forceps	44
Cotton carrier	3	Small scissors, pointed blades, matt finish	45
Electrode Cautery	2	Small scissors, pointed blades	46
Eustachian catheter probe	2	Long scissors, pointed blades	47
Screws speculum	2	Small scissors, blunt blades, matt finish	48
Spring speculum	2	Small scissors, blunt blades	49
Speculum with handle	4	Long scissors, blunt blades	50
Speculum with handle - Fiberoptic	5	Small Metzenbaum scissors, matt finish	51
Flexible tension arm	6	Mayo scissors, beveled blades, matt finish	52
Angled dissecting forceps	7	Angled scissors, dorsal scissors, lower lateral scissors	53
Angled forceps	8	Dural scissors - Scissors, serrated blades	54
Syringe	9	Fine dissecting forceps	55
Elevator, raspatory	10-11	Adson dissecting forceps	56
Suction tube elevator	12-13	Medium dissecting forceps	57-58
Scalpel	14	Dissecting forceps, 180mm	59-60
Knife	15	Dissecting forceps, 200mm	61
Raspatory	16-17	Medium bipolar dissecting forceps	62
Retractor	18-23	Medium monopolar dissecting forceps	63
Curette	24-25	Tungsten needle-holder	64
Mallet	26-27	Fine haemostatic forceps	65
Chisel - Gouge	28	Medium haemostatic forceps	66
Osteotome	29	Haemostatic forceps, serrated jaws - Forceps with teeth	67
Guarded osteotome	30	Forceps with teeth	68
Double guarded osteotome	31	Suction tube with finger control	69
Fine osteotome	32	Micro suction tube - adapters	70
Other osteotomes	33	Blunt suction tube	71-72
Straight rasp	34		
Curved rasp	35		
Double-ended rasp, 210 mm	36		

Frazier suction irrigation system	73	Wormald frontal instrumentation	102
Dessi electric irrigation pump accessories	74	Wormald skull base instrumentation	103-104
Irrigation tubing	74	Stamm skull base instrumentation	105
Sleeve for telescope	74	Sterilization case, tray, cup	106
Irrigation tube guide, trocar	75	Plastic sterilization case	107
Displacer elevator	76	Numerical index	109
Seeker, pick	77	Table for corresponding manufacturer part numbers For information purposes only	117
Knife - Elevator	78		
Dissector and knife	78		
Knife	78		
Sickle knife	78		
Fenestrated cup forceps	79		
De Gabory cup forceps	80		
Jankowski cup forceps	81		
Rouvier cup forceps	82		
Weil-Blakesley cup forceps	83		
Pediatric cup forceps	84		
Fenestrated cup forceps	85		
Cup forceps, curved down	86		
Backbiting punch forceps	87		
Pediatric backbiting punch forceps	88		
Micro punch forceps	89		
Micro fine punch cutting forceps	90		
Micro punch rongeur	91		
Nasal sinus scissors - Scissors, serrated blades	92		
Clip applier	93		
Micro bipolar forceps	94		
Micro bipolar forceps with suction	95		
Micro monopolar instruments	96		
Lemoine , Klossek, Kennedy instruments	97		
Vaughan Instruments	98		
Parsons Instruments	99		
Duncavage Instruments	100		
Levine orbital instrumentation	101		

Integra Limited Warranty

Please refer to the warranty included in the packaging of each product to know the applicable warranty.

Contacts Customer service:

International

+33 (0) 4 37 47 59 50
+33 (0) 4 37 47 59 25 (fax)
csemea@integralife.com

France

+33 (0) 4 37 47 59 10
+33 (0) 4 37 47 59 29 (Fax)
custservfrance@integralife.com

Belgium & Luxembourg

+32 (0) 2 257 4130
+32 (0) 2 253 2466 (Fax)
custsvcbenelux@integralife.com

United Kingdom

+44 (0) 1264 312 725
+44 (0) 1264 312 821 (Fax)
custsvcs.uk@integralife.com

Netherlands

+31(0) 852 083 167
+31(0) 207 093 627 (Fax)
custsvcnetherlands@integralife.com

Italy

+39 (0) 2 577 8921
+39 (0) 2 575 113 71 (Fax)
custsvcitaly@integralife.com

MicroFrance® ENT Instrumentation

INDICATIONS

- All the medical devices showed in this catalogue have indications for diagnosis and/or ENT surgery.
- Sizes are not contractual and are given for information purposes only.

CONTRAINDICATIONS

- Do not use in indications other than the indications mentioned in the DFU or Labeling.

How to read the catalogue

Title and/or product family

Detail view of the instrument

Instrument to a 1/1 scale except mentioned otherwise

Explanatory table see below

Blunt hook 90°		Blunt hook 45°		Cotton carrier twist end	Angled probe caustic holder
MCO805	MCO805A	MCO950	MCO807	7719-2	7731
2mm	2,5mm	0,8mm	1mm	Ø 1,2mm	working length 80mm

DOCUMENT FOR USE IN EUROPE, MIDDLE-EAST AND AFRICA ONLY

3

Explanation of the table reference and complementary product description

Title or subtitles	
global complementary description	
Product Ref.1	complementary description1
Product Ref.2	complementary description2

Electrode cautery



125mm
7706MF
125mm
7882

Eustachian catheter probe



160mm
7722-3
2.5mm

Spring speculum, screws speculum

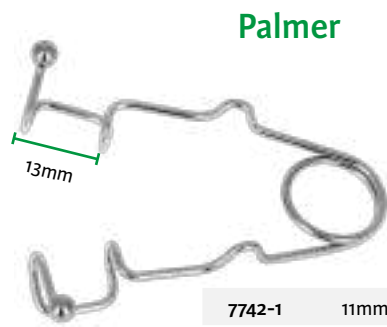

Palmer

7742-1	11mm
7742-2	13mm
7742-3	15mm

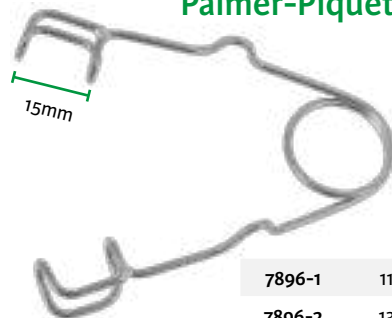

Palmer-Piquet

7896-1	11mm
7896-2	13mm
7896-3	15mm



Vacher

7746A ^{(D)*}	small
7746B ^{(D)*}	large

Air bag

Causse



Scale 1/5

7717C

^(D) Distributed by Integra MicroFrance SAS (France) - For corresponding manufacturer part numbers, see table in annex
*Please check with your sales representative availability of this product in your country

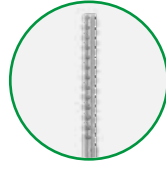
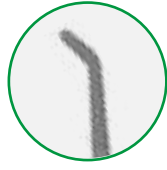
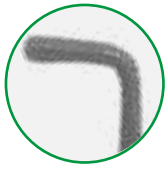

Marquet

Legent

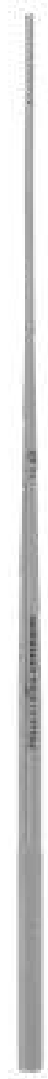

Blunt hook
90°

Blunt hook
45°

Cotton carrier, twist end
15mm

Angled probe caustic
holder

165mm

165mm

140mm

110mm

MCO805

MCO805A

MCO950

MCO807

7719-2

7731

2mm

2.5mm

0.8mm

1mm

Ø 1.2mm

working length 80mm

Hartmann



160mm

7898

Tieck-Halle



130mm

7897

Beckman



140mm

7899

Left hand

Vienna



140mm

MCO233

Dilatator



140mm

MCO237

Self-retaining
Serrated blades

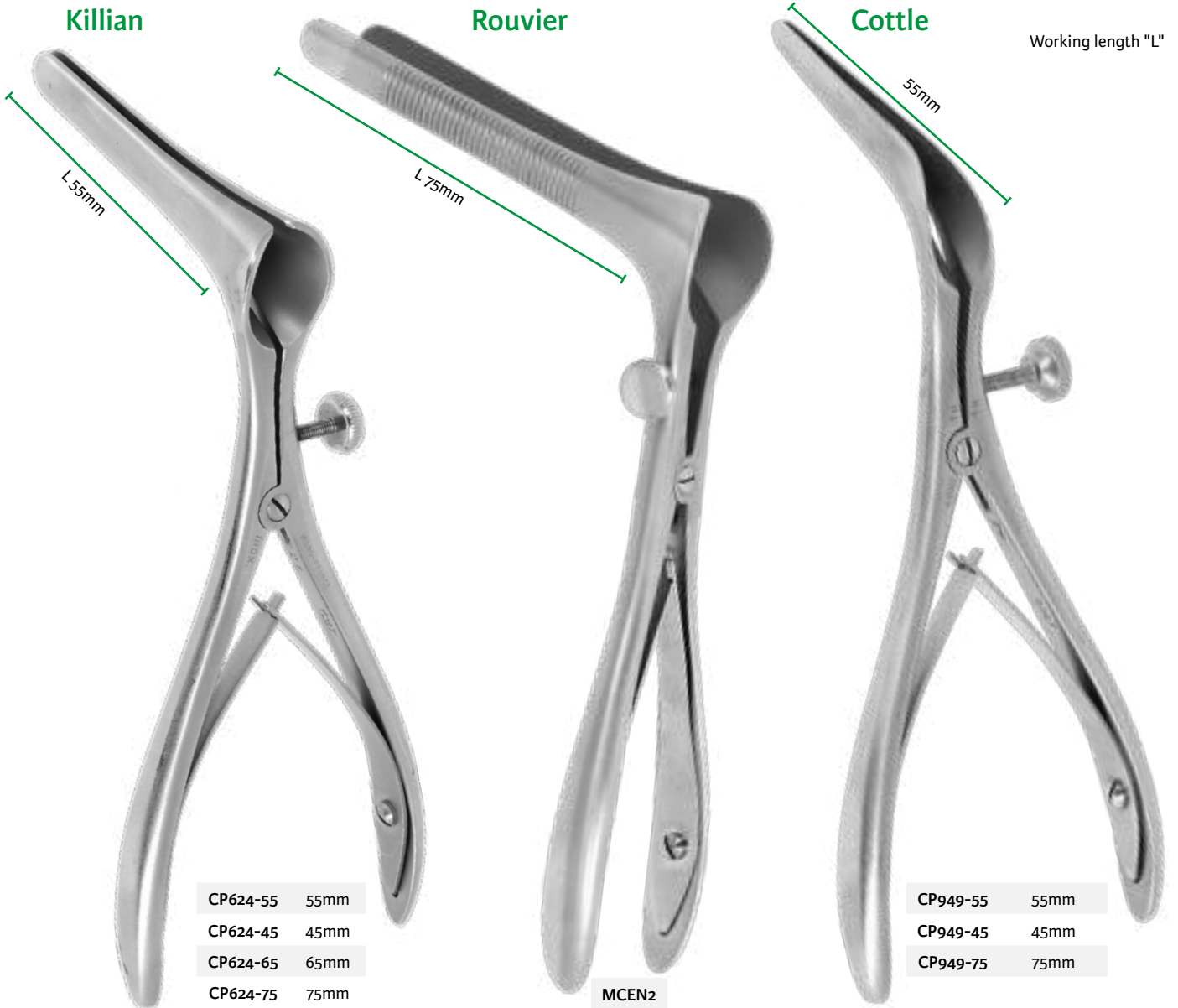

Self-retaining speculum with fiber optic - Fiberoptic 220cm - Adapters



Adapters	for generator	for instrument
Wolf	MCL170 ^{(D)(*)}	MCL171 ^{(D)(*)}
Storz	MCL173 ^{(D)(*)}	MCL174 ^{(D)(*)}
Olympus	MCL197 ^{(D)(*)}	

^(f) Not a medical device

^(D) Distributed by Integra MicroFrance SAS (France) - For corresponding manufacturer part numbers, see table in annex
*Please check with your sales representative availability of this product in your country

Flexible tension arm

Legent



Complete flexible tension arm

MCO980

Delivered with MCO981

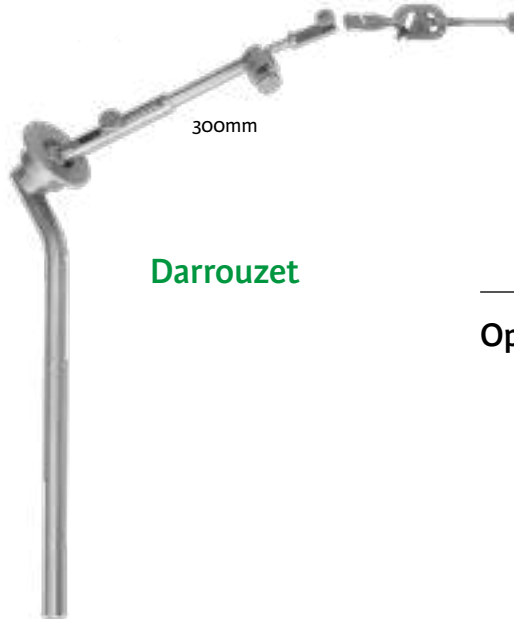

Darrouzet

Complete flexible tension arm

MCO978

Delivered with MCO978S

Operating room table clamp



CEV984

CEV985

Accessories for flexible tension arm

Ear quick-lock speculum

Articulated kneecap

Self-retaining specula



MCO981



MCO983-4



Devèze

MCO981D



MCO978S

Lucae



7726MF

Politzer



7732-1

150mm

7726MF	7727	7728
serrated jaws 1x12mm	spoon jaws	with teeth

120mm

7732-1	7733	7734
serrated jaws 1,5x14mm	spoon jaws	with teeth

Angled forceps

Scale 1/2

Serrated jaws

Rouvier

Pradès



MCEN18

MCEN19

3x8mm

0.9x7mm

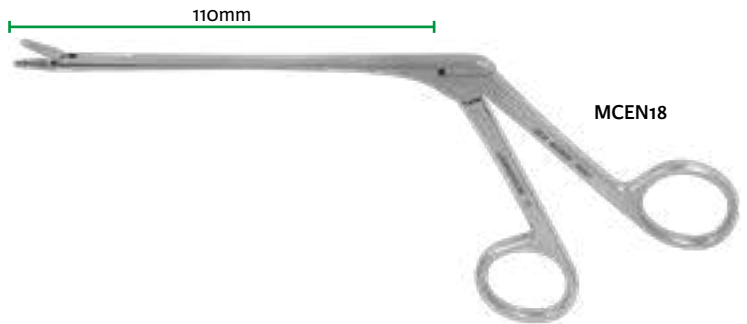

MCEN18

Lubet-Barbon

Jaws 60mm



7749

7750

smooth jaws

serrated jaws

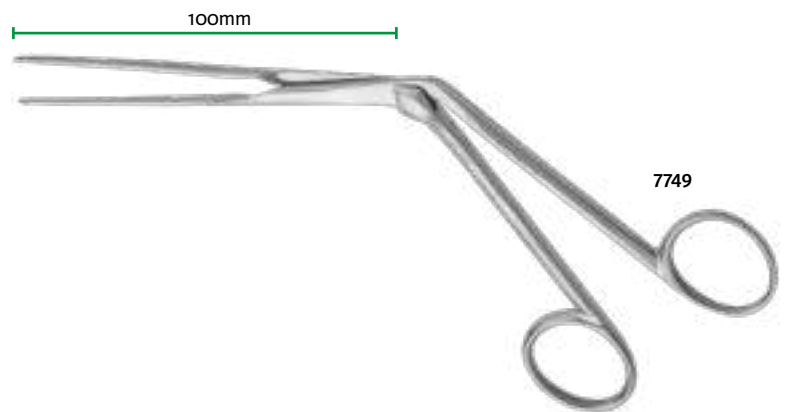

7749

Spoon jaws forceps

Brünings

Spoon jaws

Fenestrated spoon jaws



7761-1

7761-2

7761B-1

7761B-2

7.5mm

9.5mm

7.5mm

9.5mm

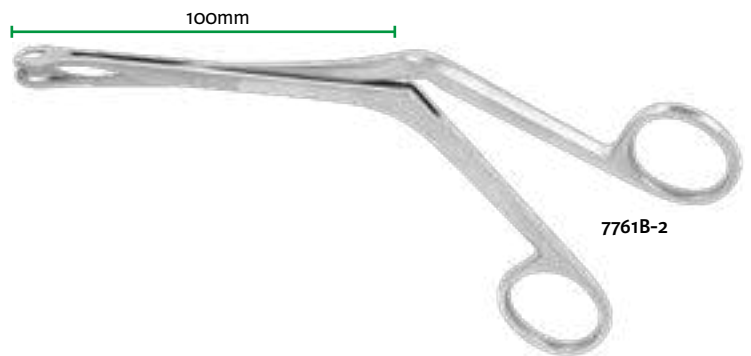

7761B-2

Luc

Spoon jaws

Fenestrated spoon jaws

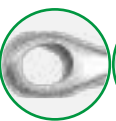
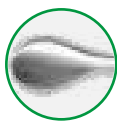

7761C1

7761C2

7761C3

7761BC1

7761BC2

7761BC3

7mm

9mm

11mm

7mm

9mm

11mm

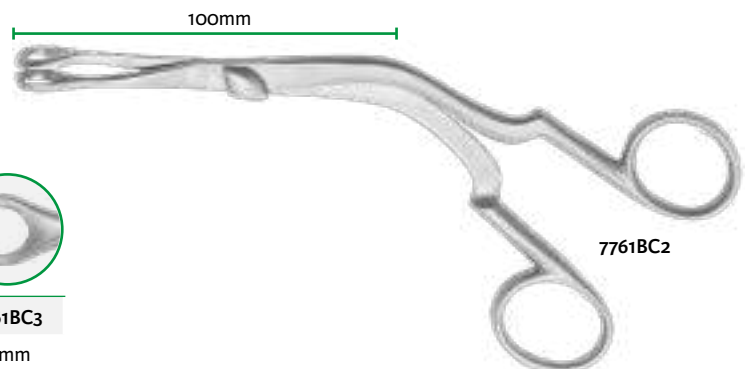

7761BC2

Syringe

Génia



7779MF-5CC

Syringe high pressure
luer-lock 5cc

Grey washer luer



7779MF-2
Pack 6

Replacement tube

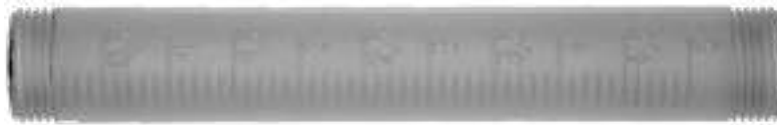

7779MF-3

White washer piston



7779MF-1
Pack 6

Sébileau



190mm

CP985

5mm

Fleury



180mm

MCO305

8,5mm

Freer



160mm

MCO803

2,5mm

Howarth



185mm

CP611

5mm



220mm

CP625

Cottle



220mm
CP626

McKenty



240mm
CP627

Rouvier

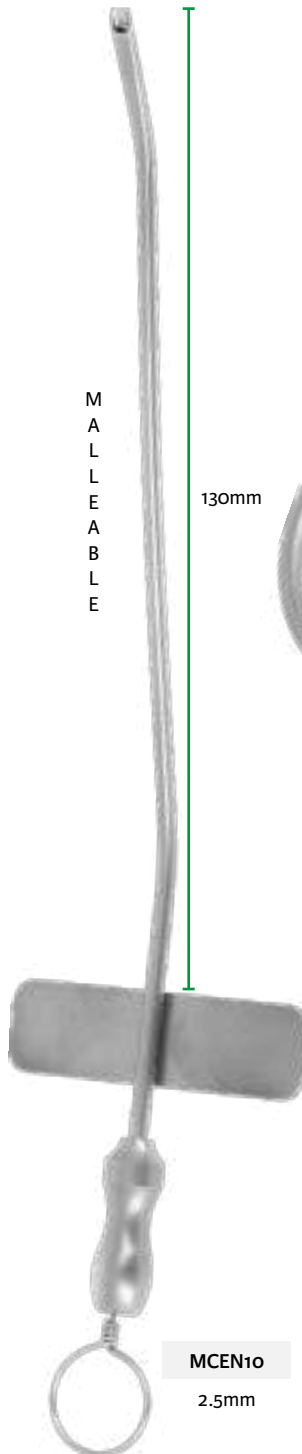

MCEN10
2.5mm

Orsel

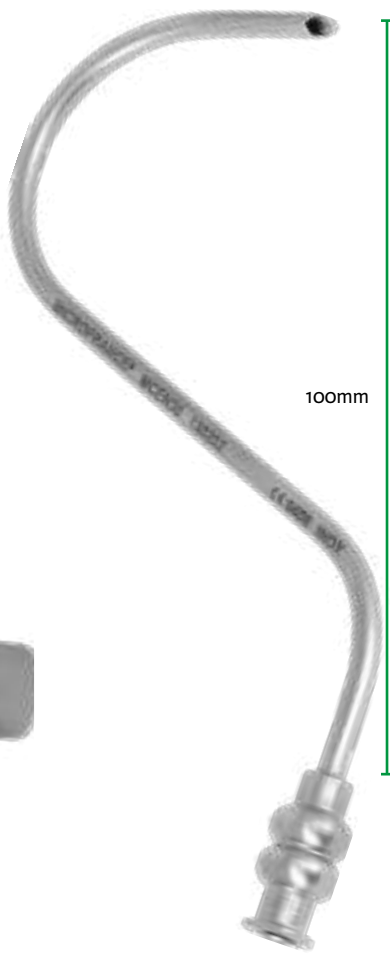

MCEN39
3mm



MCEN764
3.5mm
sharp

MCEN765
3.5mm
blunt



Orsel

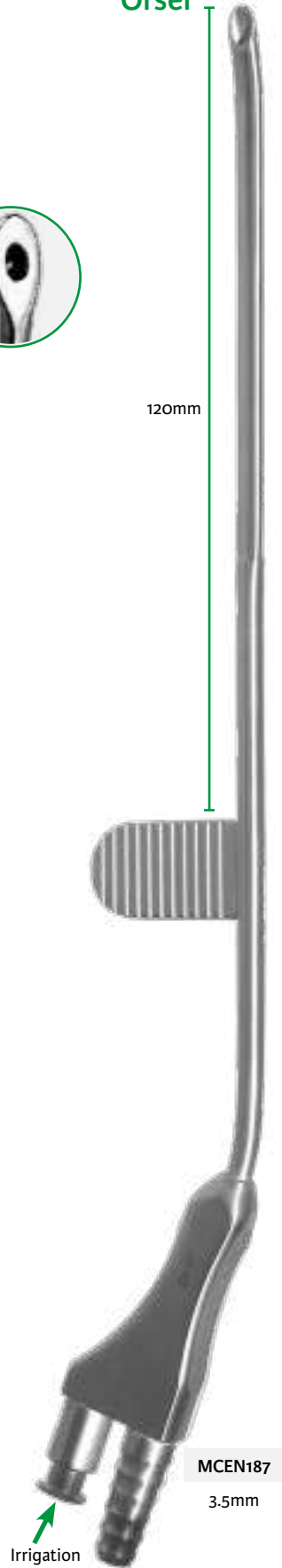

MCEN187
3.5mm
Irrigation





120mm

1003IG^(D)*

N° 3



160mm

1005I^(D)*

N° 7



200mm

1003LI^(D)*

N° 3L



150mm

CP821



120mm

1004IG^(D)*

N° 4

blades 23

use with blades 11/15

^(D) Distributed by Integra MicroFrance SAS (France) - For corresponding manufacturer part numbers, see table in annex
*Please check with your sales representative availability of this product in your country

Ballenger



200mm	
CP622-4	4mm
215mm	
3714164	3mm
3714166	5mm

Joseph



160mm	
CP333	angled

Joseph



160mm	
3714678	
7mm	

Farabeuf

Fleury

Sébileau

Plester



150mm

7787-10

10mm



170mm

MCO979

6,5mm



150mm

CP825

4mm



180mm

MCO988

7,5mm



195mm

3724059

6,5mm

Joseph

Obwegeser

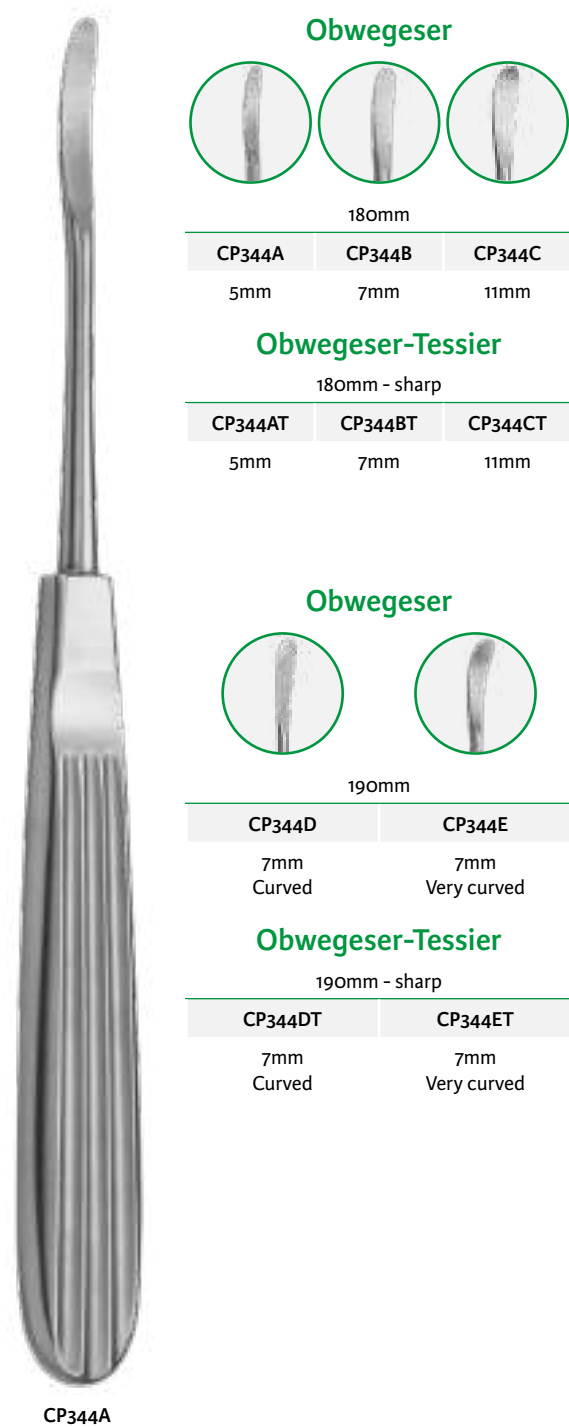
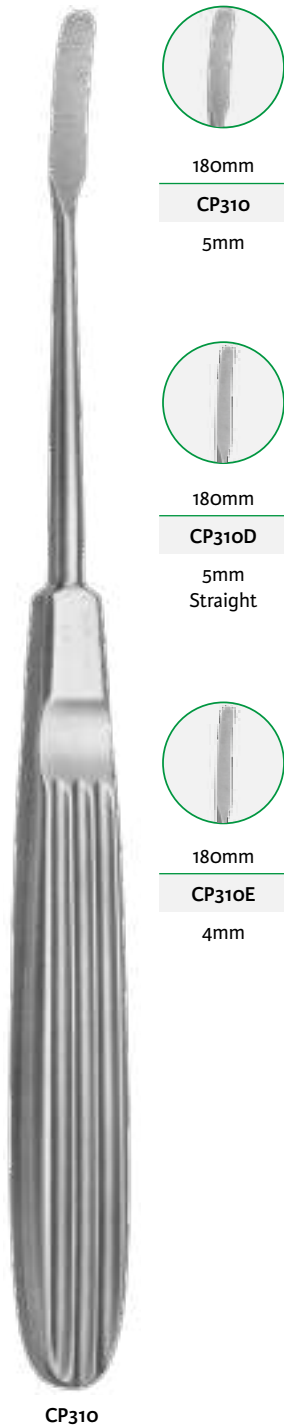

Farabeuf

Desmarres

Gillies

Gillies

Humby



140mm 120mm
7768-1 7768
pair pair

140mm
CP822-12
12mm
CP822-10
10mm
CP822-14
14mm

180mm
CP17
3mm
CP17-1
2mm

145mm
CP17-3
2mm
CP17-2
3mm

145mm
CP628
5mm

110mm
CP941
articulated

Kleinert-Kutz



160mm

3714024	3mm
3714025	5mm
3714026	7mm

Cottle



145mm

3714107	4mm
very curved	
3714108	4mm
3714109	5mm

Sisson



150mm

3714111	6mm
---------	-----

Converse



180mm

3714364	2,5mm
---------	-------

Frazier



130mm

3724256	3,5mm
---------	-------

Knapp



150mm

3714027

8mm

3714028

blunt

Volkmann



140mm

CP21-3

sharp

CP21A-3

blunt



150mm

7782-1-2



180mm

CP335



160mm

CP609

3 sharp prongs

80mm

CP340

Cloué



110mm

CP341

Converse



95mm

CP331

CP331-1

sharp

blunt

Kilner



125mm

CP803

Jost



120mm

CP338



130mm

CP339



Aufricht



170mm
CP306 45mm

Cottle



130mm
3714187

Cottle



130mm
3714182 Right tip sharp,
left ball tip
3714183 Left tip sharp,
right ball tip

Joseph



CP23-4
4mm



CP23-6
6mm



CP23-8
8mm



CP23A-8
8mm
mousse



CP23-10
10mm

160mm
CP23-10
10mm



220mm

CP630

with loop
and ball

Ragnell



160mm

CP632

Dufourmentel



170mm

CP947



Lima

Frèche

Jankowski

Klosssek

M
A
L
L
E
A
B
L
E

M
A
L
L
E
A
B
L
E

2,2mm

2mm

2,2mm

5mm

250mm

774

4x6mm

220mm

MCEN104

6x8mm

220mm

MCEN109

4x6mm
including bent tool

200mm

MCEN106

200mm

MCEN107

Scale 1/1

Straight curette

Volkman



CP302-6

170mm								
<input type="radio"/>	CP302-2	2mm	<input type="radio"/>	CP302-4	4mm	<input checked="" type="radio"/>	CP302-6	6mm
<input type="radio"/>	CP302-3	3mm	<input type="radio"/>	CP302-5	5mm	<input type="radio"/>	CP302-8	8mm



165mm - 110g

MCO995

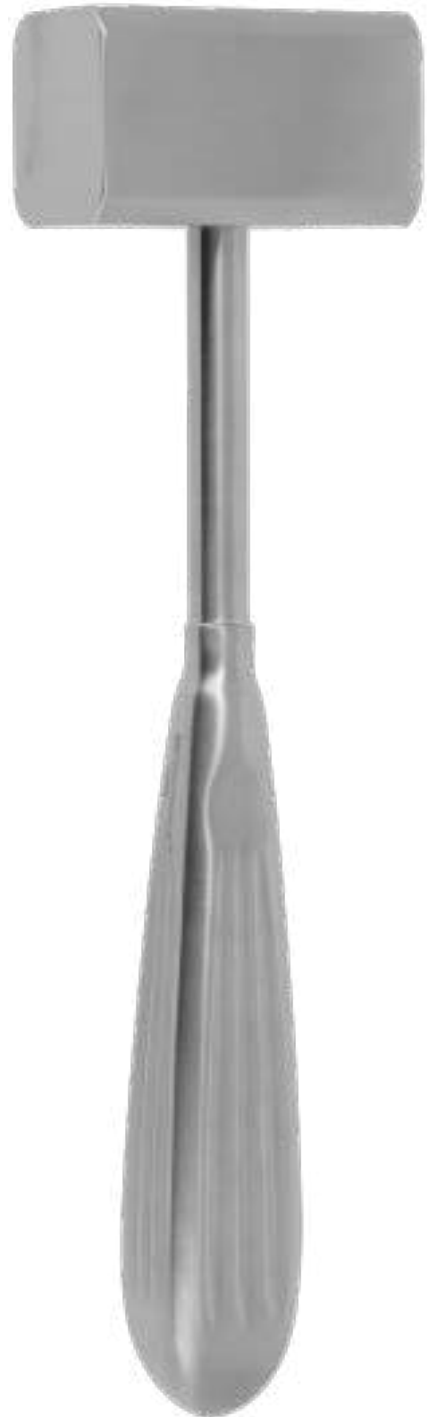

Lombard

185mm - 330g

7766



180mm - 200g

CP907

1 teflon head



180mm - 230g

CP300

Jost



Ballenger



Metzenbaum



Fleury

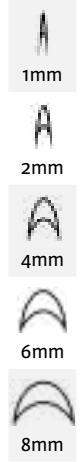

Chisel

Gouge

Straight

Straight 'V' shaped

Bayonet

Bayonet 'V' shaped

Straight

180mm

150mm

150mm

150mm

150mm

130mm

CP801-7	7mm
CP801-10	10mm

3714055	2mm
3714056	4mm
3714057	6mm
3714058	8mm

3714320	5mm
---------	-----

CP823-5	5mm
---------	-----

CP824-5	5mm
---------	-----

MCO214-13-10	1mm
MCO214-13-20	2mm
MCO214-13-40	4mm
MCO214-13-60	6mm
MCO214-13-80	8mm

Aiach



160mm

CP317

16mm

Pollet-Pech



160mm

CP318

13mm

Marchac



180mm

CP304-10

Size	Curved	Straight
 2mm	CP304B-2	CP304-2
 3mm	CP304B-3	CP304-3
 4mm	CP304B-4	CP304-4
 5mm	CP304B-5	CP304-5
 6mm	CP304B-6	CP304-6
 7mm	-	CP304-7
 8mm	CP304B-8	CP304-8
 9mm	-	CP304-9
 10mm	CP304B-10	CP304-10
 11mm	-	CP304-11
 12mm	CP304B-12	CP304-12
 14mm	-	CP304-14
 15mm	-	CP304-15
 16mm	-	CP304-16

Tessier

Jost

Marchac

Claoué

Silver



180mm

CP316



180mm

CP802



180mm

CP315



CP315

Pech-Marchac



CP315D

curved right

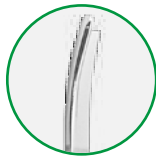

CP315G

curved left



180mm

CP305



CP305

Lindas

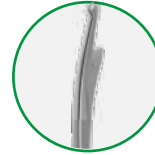

CP305L

curved left

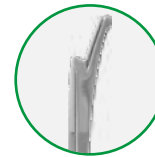

CP305R

curved right



180mm

3714098

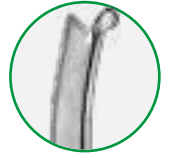

3714098

curved right



3714099

curved left

Mac-Indoe



180mm
CP314-14
14mm

Robin



160mm
CP309-14-16



CP309-8-12
8 - 12mm

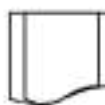

CP309-10-14
10 - 14mm

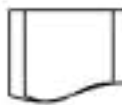

CP309-12-16
12 - 16mm

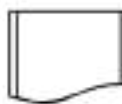

CP309-14-16
14 - 16mm



CP309-14-18
14 - 18mm

Cottle



195mm
CP808-6
6mm

Cottle



195mm
CP806
6mm

Cottle



190mm
CP807
5mm

Becker



200mm
CP313

Parkès



170mm

3714096

4mm

Maltz



170mm
CP301-1

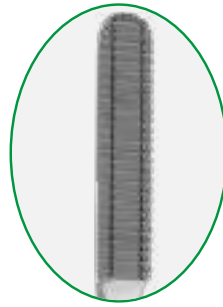

Maltz

CP301-1

8x35mm - downstroke

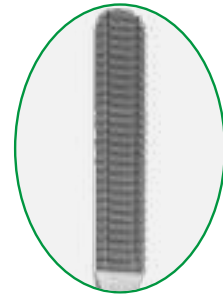

Maltz

CP301

10x45mm - downstroke

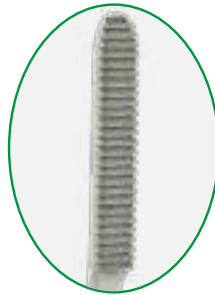

170mm

CP905

8x35mm, downcutting,
concave

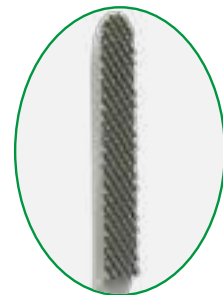

170mm

CP828

8x35mm - downstroke



170mm

CP978

8x35mm, straight, coarse

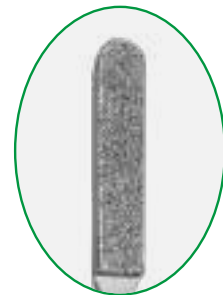

180mm

CP810

8x30mm, straight, diamond

Aufricht

200mm



CP973

8x25mm
downward
cutting



CP974

8x25mm
upward cutting

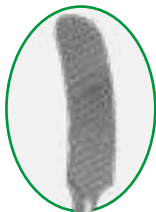

CP976

8x30mm
bi-directional



200mm

CP1100

8x8mm

Bigot



200mm

CP291

4x15mm



190mm

CP998-1

8x12mm
cross-cutting

Fomon

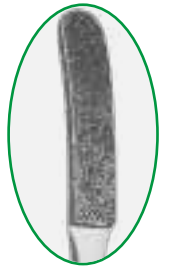

180mm

CP809

8x30mm
diamond



175mm

CP301-3

7x20mm
concave
downward
cutting



180mm

CP301-2

8x30mm
downward cutting

Becker

Becker

Fomon

Rees

Gorney

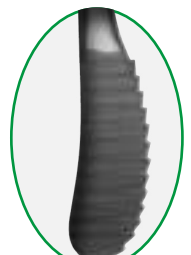

CP301-10
7x38mm-7/8
Sure-Grip™
tungsten

CP1104
7x20mm-1/2
Sure-Grip™
tungsten

CP1105
7x20mm-3/4
Sure-Grip™
tungsten

CP301-4
7x38mm
coarse

CP301-5
7x38mm
coarse

CP301-9
7x12mm
8x22mm

Fomon



210mm

Double-ended
one convex
one flat
coarse teeth

3714149 7mm

fine teeth

3714148 7mm

3714149

Aquaplast™ nasal splint

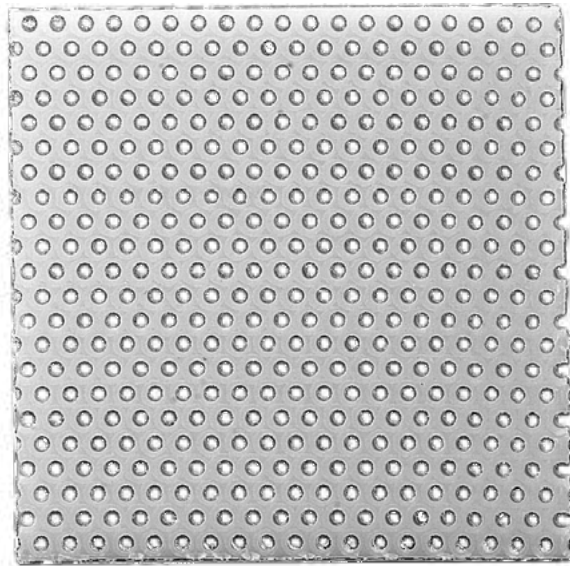

AQ1728^(D)*

75x75mm - Pack 10
not sterile, single use

Cartilage template

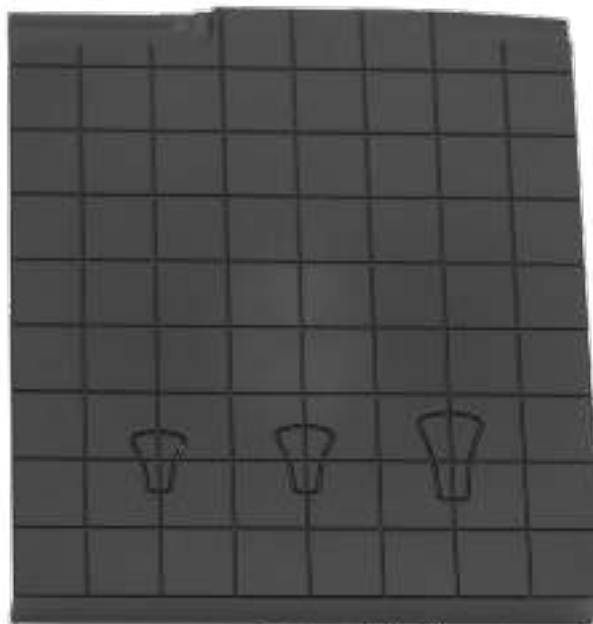

CP1109

80x90mm
with graduations

^(D) Distributed by Integra MicroFrance SAS (France). For corresponding manufacturer part numbers, see table in annex
*Please check with your sales representative availability of this product in your country

Scale 1/2

Cartilage crushing press

Jost

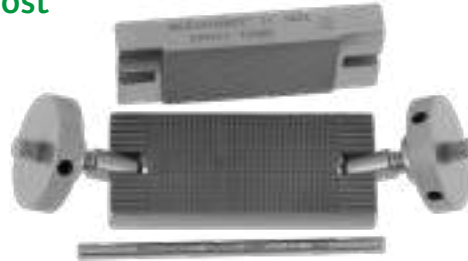

CP814-1

Delivered with key CP814-3



CP814-2

Smooth plate device 30x50mm
for CP814-1



CP814-3

Tightening key
for CP814-1

Scale 1/2

Perforator bone forceps

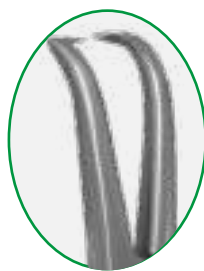

Stoll

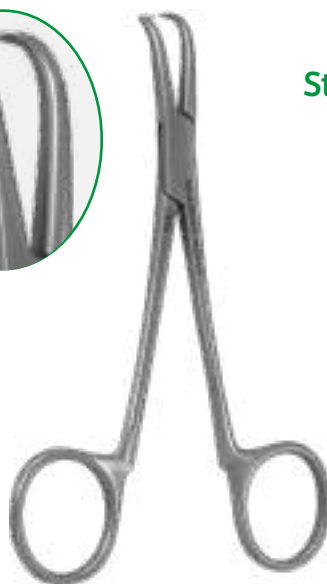

150mm

CP640

Scale 1/2

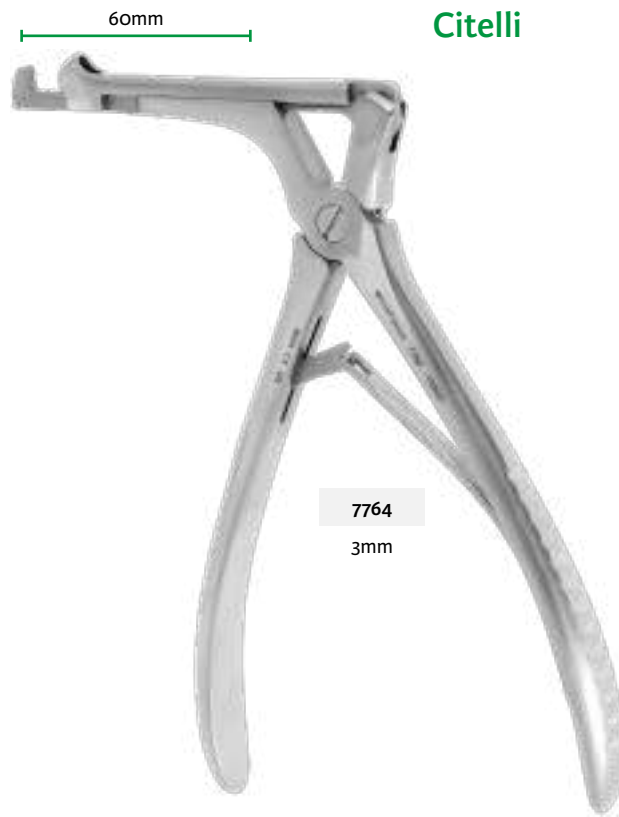

Beyer



CP380

160mm

CP380	CP380-2
straight jaws 2mm	curved jaws 2mm

Beyer



CP380-3

180mm

CP380-3	CP380-5	CP380-1
curved jaws 2mm	curved jaws 4mm	straight jaws 2mm

Jansen-Middleton



180mm

Double-action rongeur

CP621 4x20mm

Scale 2/3

Double-action bone rongeur

Ruskin



160mm

CP381

Scale 2/3

Martin



240mm

7765

Delivered with 2 jaws

Offret

Scale 3/4



100mm
CP353
strong curvature



100mm
CP356

Streiff

Joseph

Fox



105mm
CP16-1 CP16
Curved blades Straight blades



110mm
CP919A CP919
Curved blades Straight blades



110mm
CP358A CP358
Curved blades Straight blades

Joseph

Kilner-jost



120mm - matt finish

CP354A	CP354
Curved blades	Straight blades

120mm - matt finish

CP362
Curved

Boetcher

Brophy

Joseph



180mm

CP997

Curved



CP367-1

150mm

CP367-1

Curved

CP367

Straight

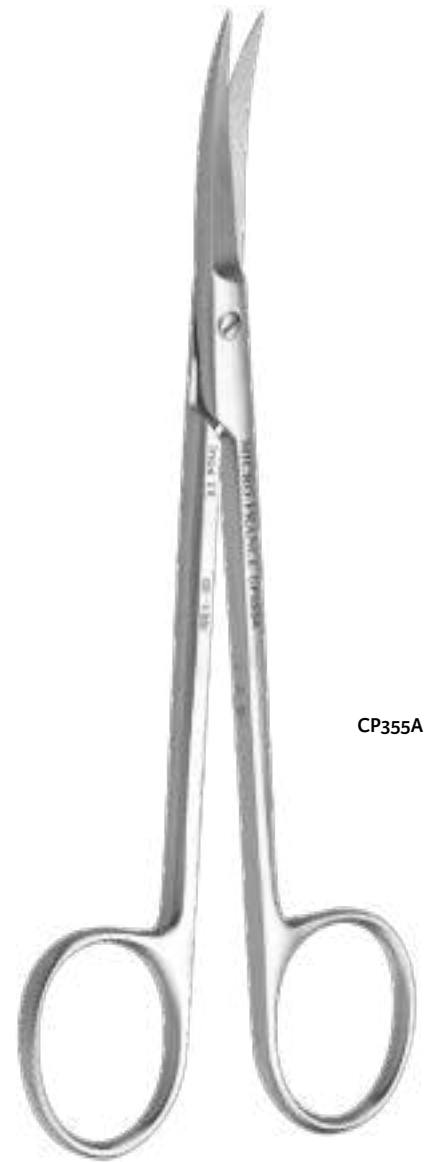

CP355A

150mm

CP355A

Curved

CP355

Straight

Bregat

Stevens

Stevens



110mm
CP363
Curved blades



110mm - Tenotomy scissors
CP922
Straight blades



110mm - Tenotomy scissors
CP922A
Curved blades

Stevens

Shea

matt finish

matt finish



115mm - Tenotomy scissors

CP922B

Curved blades



120mm

CP637

Curved blades

Reynolds



160mm

CP921

Ragnell

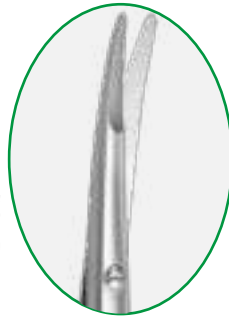

150mm

CP616-15



130mm

CP616-13

Joseph



150mm

CP355C

Léger



150mm

CP365

Metzenbaum



110mm

CP351-7	CP351-6
Curved blades	Straight blades

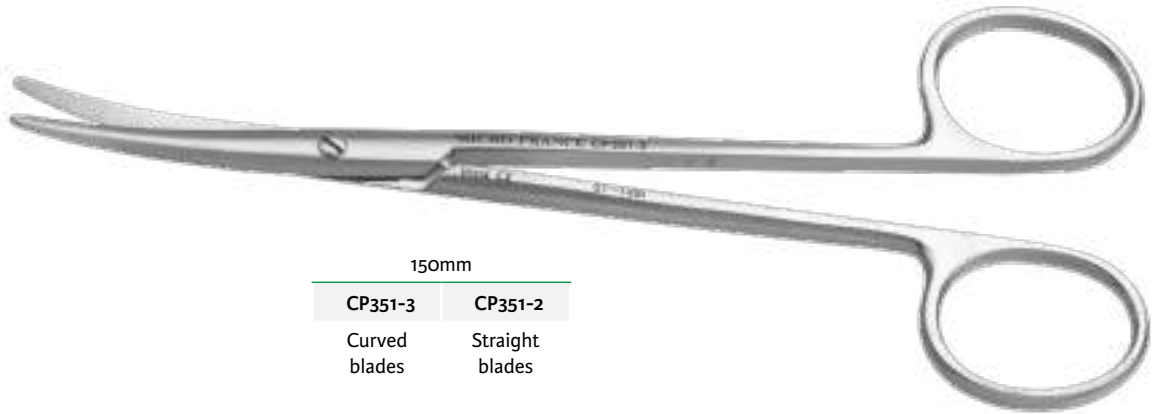

150mm

CP351-3	CP351-2
Curved blades	Straight blades

Delicate curved scissors

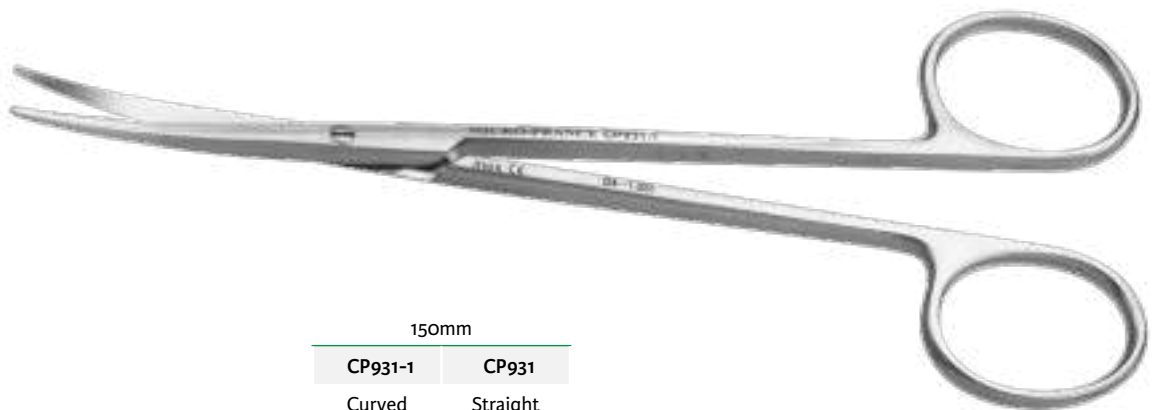

150mm

CP931-1	CP931
Curved blades	Straight blades

Mayo



Becker-Converse

100mm

CP1106

Angled scissors
serrated blades



Converse

100mm

CP348

Angled scissors



Fomon

Fomon



140mm

CP612

lower lateral scissors
very curved

Cottle

Pellegrini

Cottle-Pech

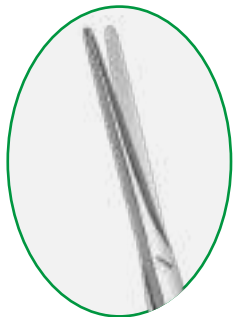

140mm

CP635

dorsal scissors

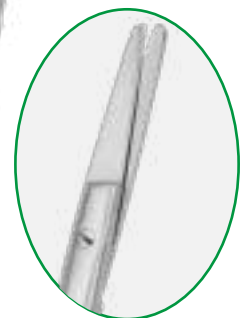

150mm

CP359

dorsal scissors
serrated blades



140mm

CP613

dorsal scissors - blunt tip

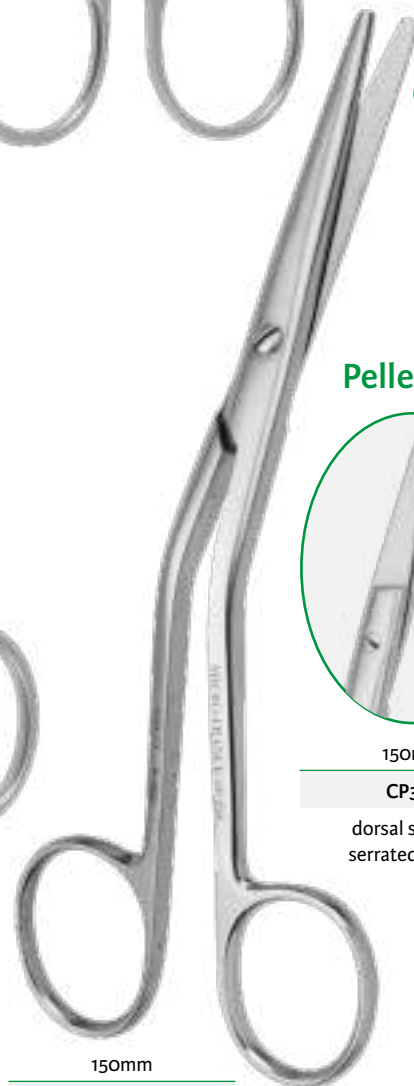

150mm

CP614

dorsal scissors

Heymann-Klossek

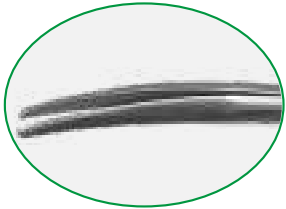
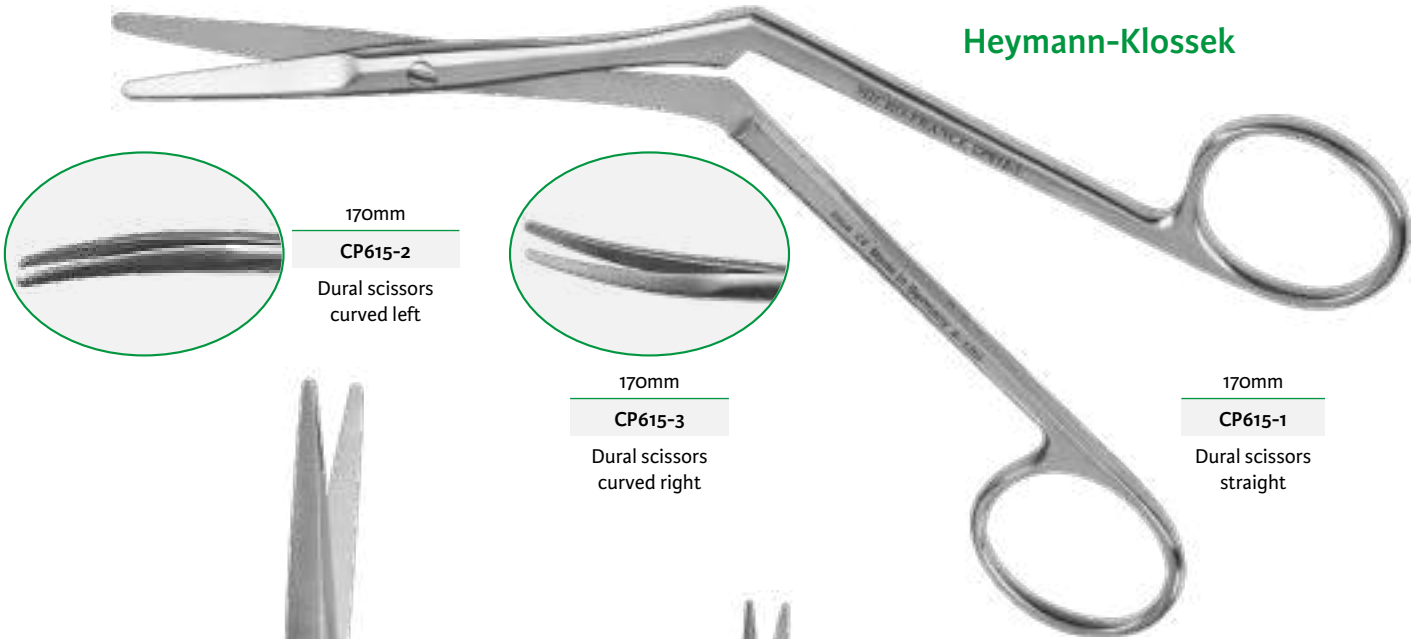

170mm
CP615-2
Dural scissors
curved left



170mm
CP615-3
Dural scissors
curved right

170mm
CP615-1
Dural scissors
straight



180mm
CP350
Straight scissors
serrated bayonet blades

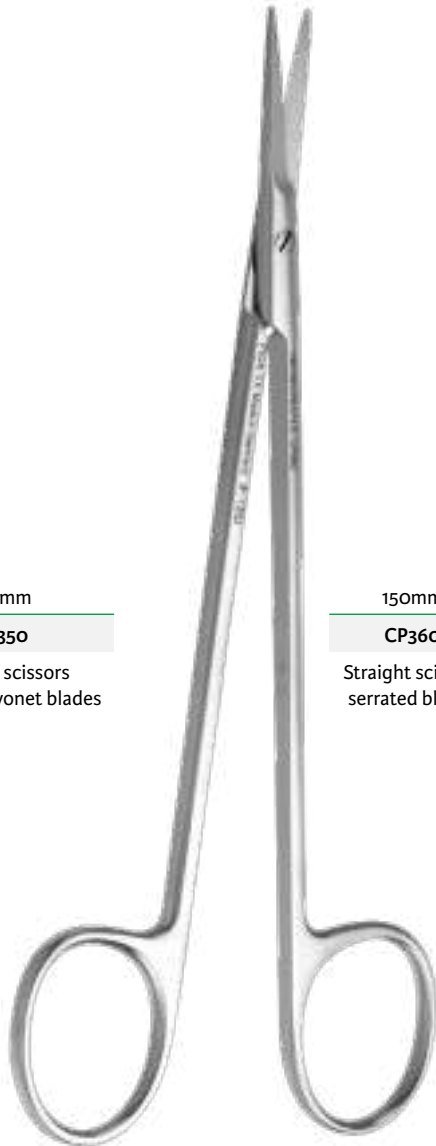

150mm
CP360
Straight scissors
serrated blades



120mm
713T
Wire cutting
dural scissors
tungsten
notched blades

Bebee

Dissecting forceps 110mm

Castroviejo



CP938-1

Horizontal teeth and platform

Castroviejo



CP37

Oblique teeth and platform



CP332

Serrated jaws 1.4mm

Dissecting forceps 120mm



Serrated jaws

CP414

Jaws 1mm



7831A-12

Jaws 1.5mm



CP406

Jaws 1mm



Jaws with teeth

7833A-12

Jaws 1.5mm



CP400-1

5x5 teeth

150mm

Adson



CP604-15 Serrated jaws 1.5mm
CP605-15 1x2 teeth jaws 1.5mm

Adson-Brown



CP606-15 7x7 teeth

120mm



Adson-Tubiana

Jaws 1mm

Adson

Jaws 1,5mm

Jaws 1,5mm

Adson-Brown

Jaws with 7x7 teeth

M832	M833	CP604	CP605	CP606A	CP606
serrated jaws	1x2 teeth	serrated jaws	1x2 teeth	tungsten serrated jaws	

Mac-Indoe

140mm



CP934 Oblique teeth and serrated platform

CP934-1 Serrated jaws

Debakey

Barraya

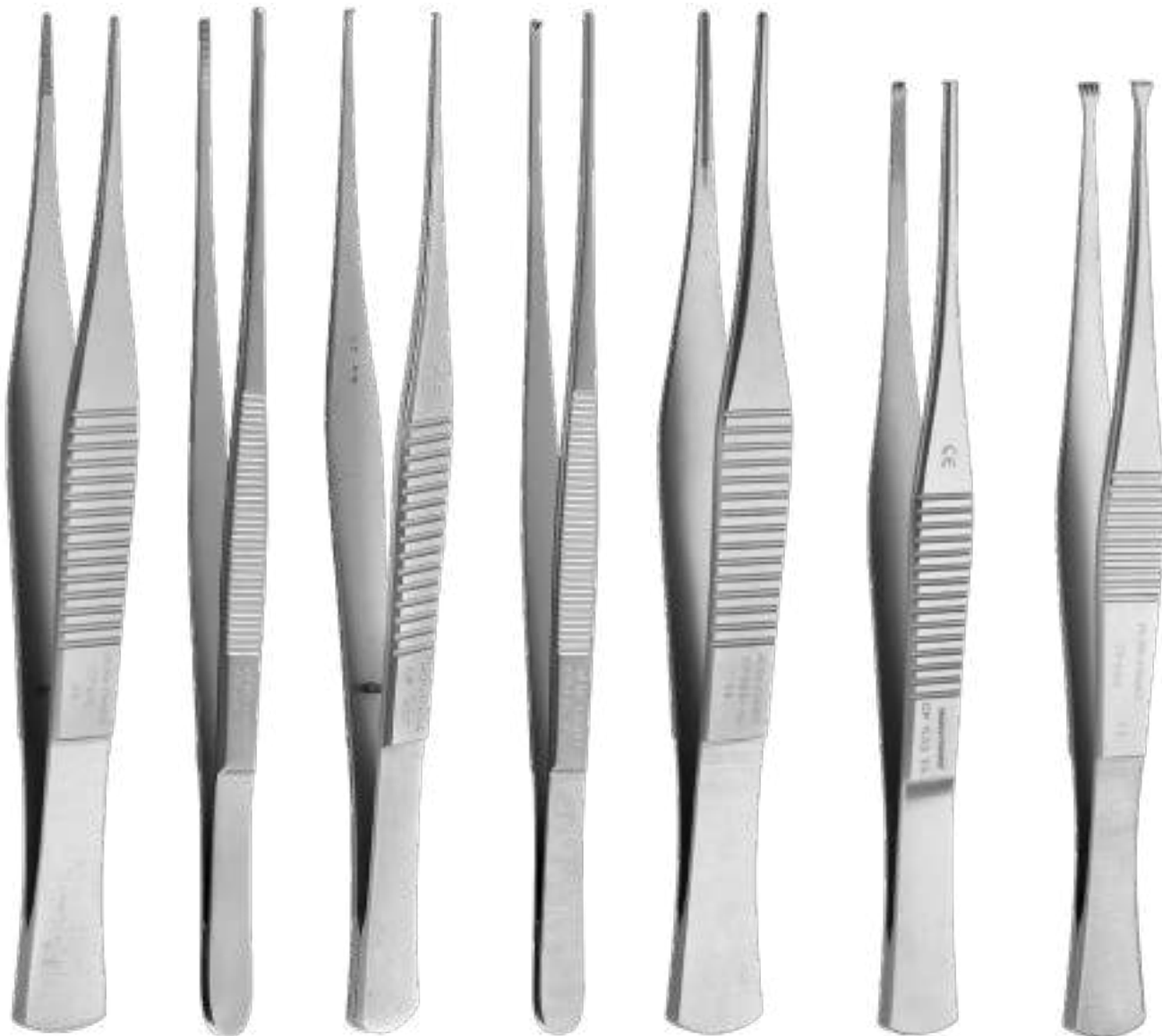

150mm

140mm

CP415	7831A-15	CP407	7833A-15	CP988-15	CP933-14	CP400
Serrated jaws 1mm	Serrated jaws 1.5mm	1x2 teeth jaws 1mm	1x2 teeth jaws 1.5mm	Serrated jaws 1.5mm	3x4 teeth and serrated platform	5x5 teeth

Précelle



150mm

CP345

serrated angled jaws

Barraya



160mm

CP933-16

3x4 teeth and
serrated platform

Claoué



160mm

CP401

5x6 teeth

Mac-Indoe



170mm

CP936

1x2 teeth and
serrated platform

Debakey



1,5mm
7831A-18
serrated jaws



1,5mm
CP988-18
serrated jaws



1mm
CP409
1x2 teeth

Barraya



1,5mm

7833A-18

1x2 teeth



1,5mm

CP933-18

3x4 teeth and serrated platform



6x6 teeth

CP400-2

Debakey



200mm	210mm
7832	7834
1mm	1mm
serrated jaws	1x2 teeth



2mm
7831A-20
serrated jaws



1,5mm
CP988-20
serrated jaws



2mm
7833A-20
1x2 teeth

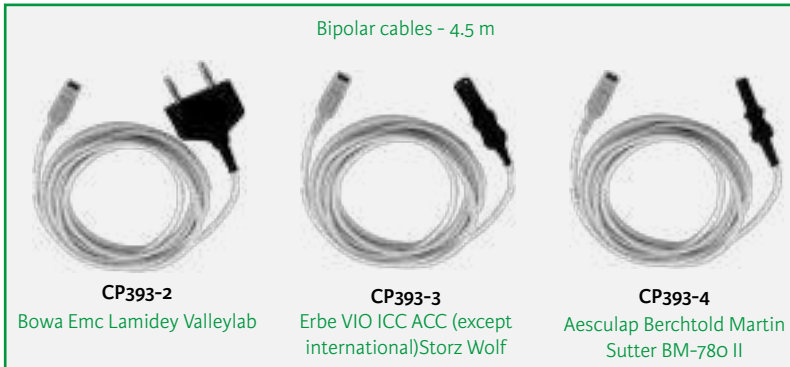

Magnan



Adson



110mm		120mm		160mm		200mm	
CP392-1R	CP604BR	CP605BR	CP392-2R	CP392-8R	CP392BI	CP392BS	
smooth jaws 1x8mm	serrated jaws 1.5mm	1x2 teeth 1.5mm	smooth jaws 1x8mm	smooth jaws 1x8mm	smooth jaws 0.5x5mm	smooth jaws 0.5x5mm	



Adson



110mm

CP390-1

Smooth jaws
1x8mm



120mm

CP604M

Serrated jaws
1.5mm



CP605M

1x2 teeth
1.5mm



160mm

CP390-2

Smooth jaws
1x8mm



CP390-8

1x2 teeth
1x8mm

Halsey

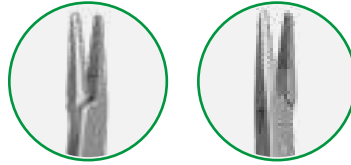

130mm

703T	704T
serrated jaws	Smooth jaws
for needle 4/0 5/0	



703T

Crile-Wood Mayo-Hégar

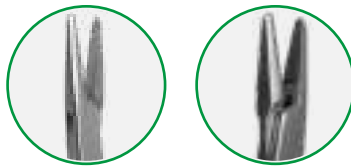

150mm

702T	714T
needle 4/0 5/0 6/0	1/0 2/0 3/0 4/0



702T

Becker

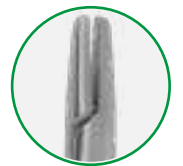

130mm

CP1107
Diamond jaws

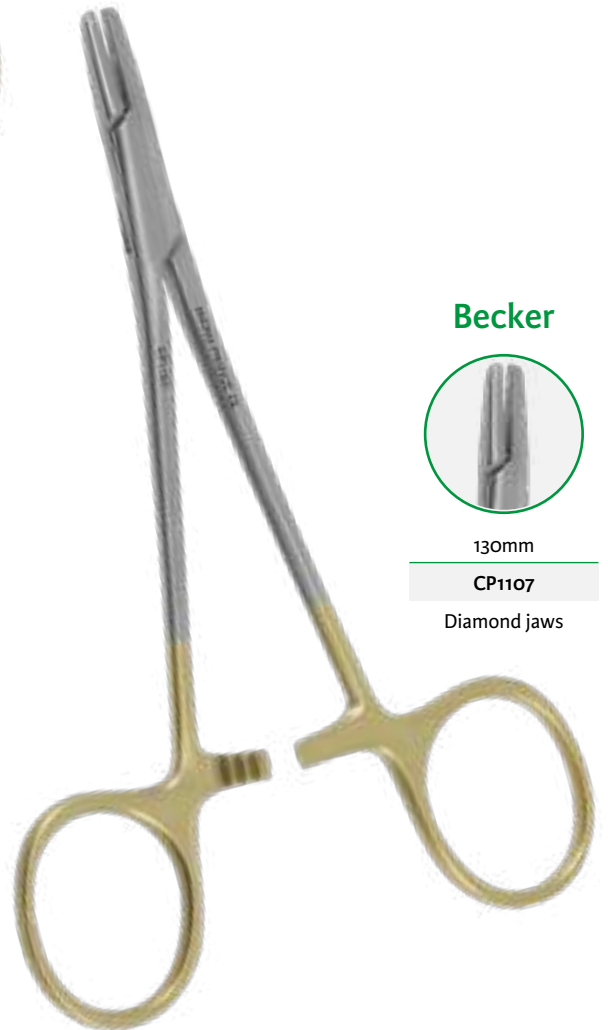



Leriche

140mm - without teeth

7867-1	7867-2
--------	--------

Straight	Curved
----------	--------

140mm - with teeth

7867-3	7867-4
--------	--------

Straight	Curved
----------	--------

7867-1



Halsted

120mm - with teeth

P761-7	P761-8
--------	--------

Straight	Curved
----------	--------

P761-7

Kelly

without teeth

140mm	160mm
P762-2	P762-4
Curved	Curved



P762-2

Kocher

140mm 160mm 180mm

Straight without teeth

P764-1	P764-5	-
--------	--------	---

Straight with teeth

P764-3	P764-7	P764-11
--------	--------	---------



P764-3



Martel

130mm

P763

Forceps with teeth, 'T' tip

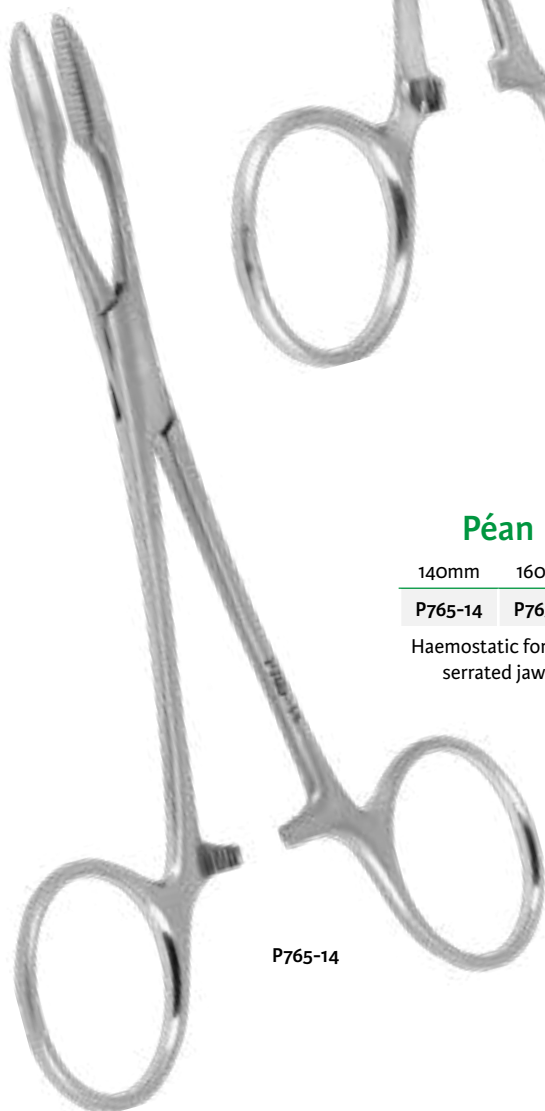

Péan

140mm 160mm

P765-14 P765-16

Haemostatic forceps serrated jaws

P765-14

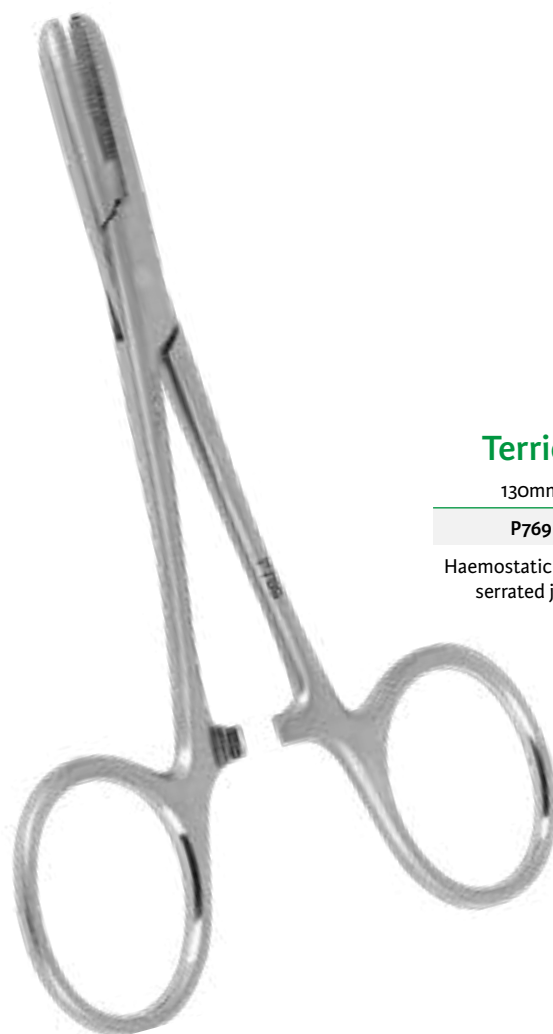

Terrier

130mm

P769

Haemostatic forceps serrated jaws

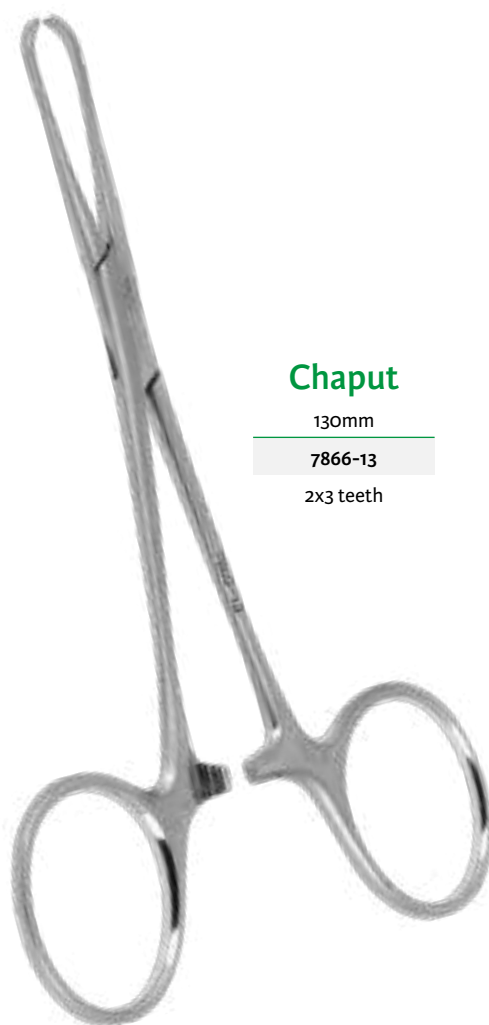

Chaput

130mm

7866-13

2x3 teeth

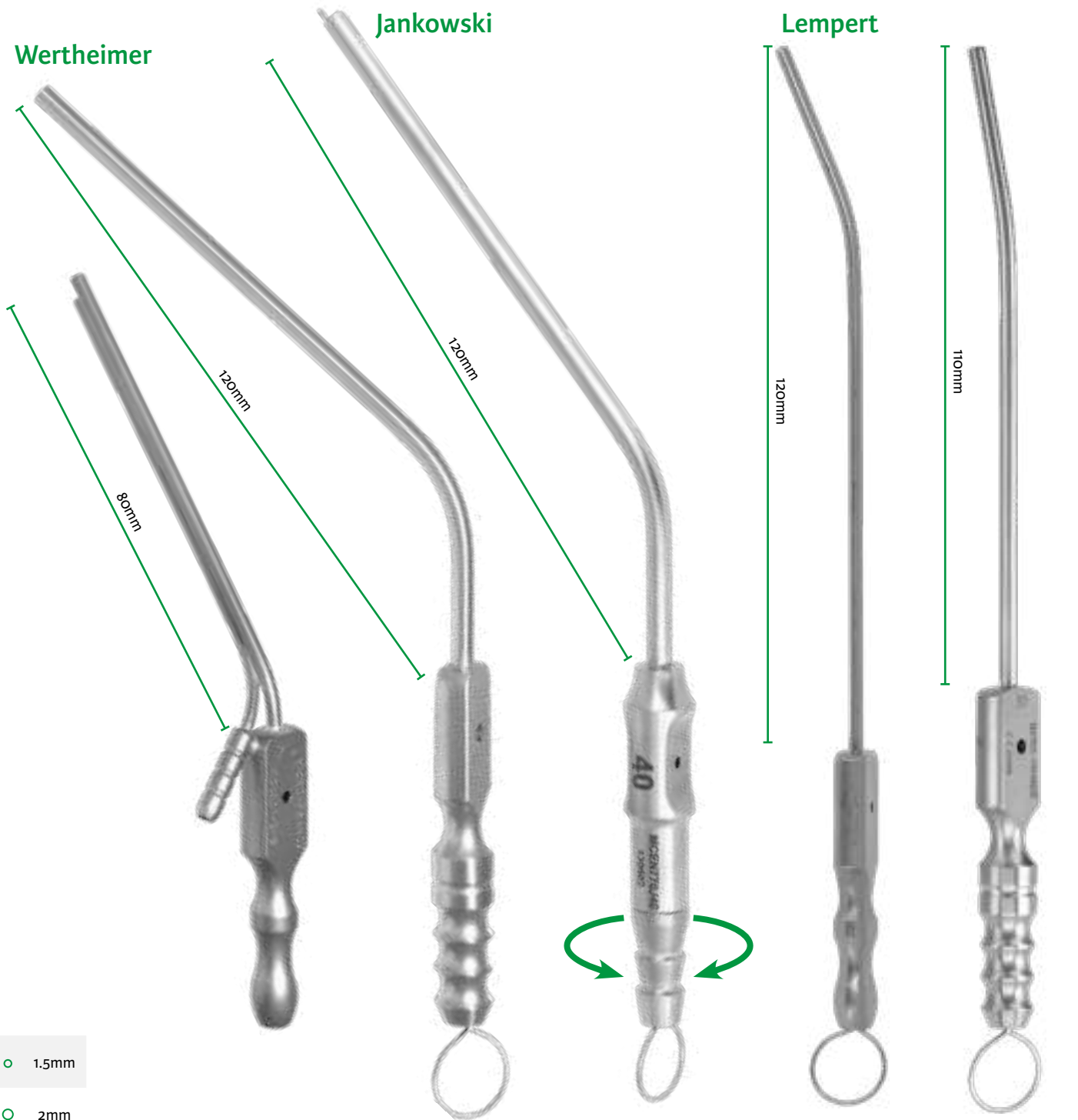

- 1.5mm
- 2mm
- 2.5mm
- 3mm
- 3.5mm
- 4mm

Wertheimer		Jankowski		Lempert	
MCO201-2-5	2.5mm	MCO770-1-5	1.5mm	MCO771-2-5	2.5mm
MCO201-3-0	3mm	MCO770-2-0	2mm	MCO771-3-0	3mm
		MCO770-2-5	2.5mm	MCO771-4-0	4mm
		MCO770-3-0	3mm		
		MCO770-3-5	3.5mm		
		MCO770-4-0	4mm		
				CP330-3-0	3mm
				CP330-4-0	4mm

Luer-lock adapter

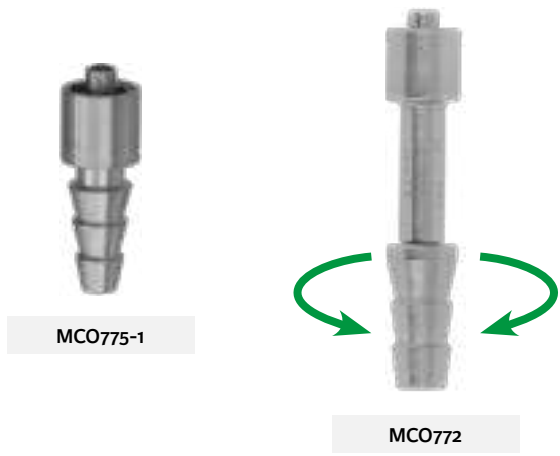

Suction tube adapter with finger control



Benzeth

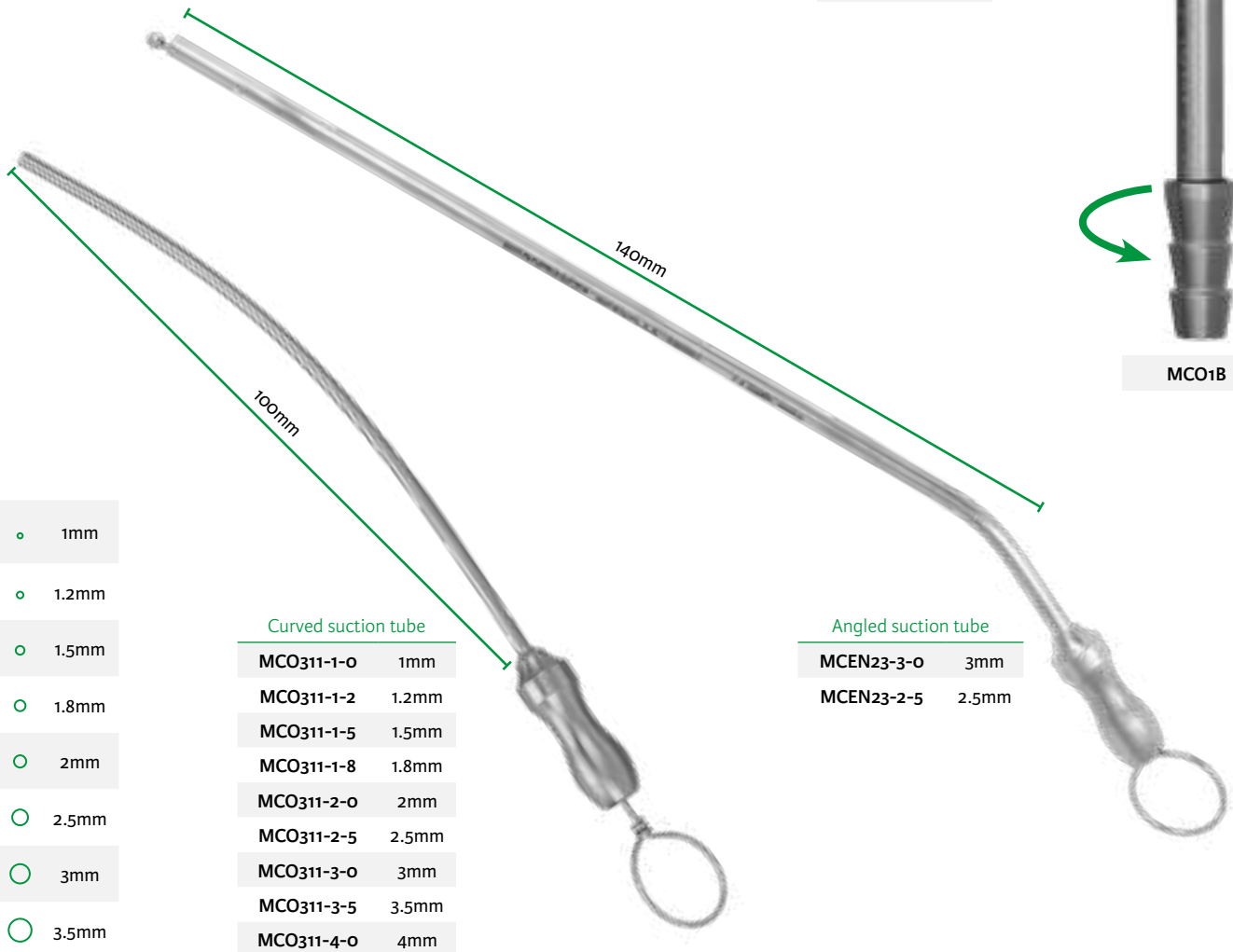

- 1mm
- 1.2mm
- 1.5mm
- 1.8mm
- 2mm
- 2.5mm
- 3mm
- 3.5mm
- 4mm

Curved suction tube

MCO311-1-0	1mm
MCO311-1-2	1.2mm
MCO311-1-5	1.5mm
MCO311-1-8	1.8mm
MCO311-2-0	2mm
MCO311-2-5	2.5mm
MCO311-3-0	3mm
MCO311-3-5	3.5mm
MCO311-4-0	4mm

Angled suction tube

MCEN23-3-0	3mm
MCEN23-2-5	2.5mm

110mm

MCEN37-1-20	2mm
MCEN37-1-25	2.5mm
MCEN37-1-30	3mm
MCEN371D35	3.5mm
MCEN371D4	4mm

Malleable

MCEN37-2-0	2mm
MCEN37-2-5	2.5mm
MCEN37-3-0	3mm
MCEN37-3-5	3.5mm
MCEN37D4	4mm



De Gabory

Handle for suction tube
rotatable connection

MCEN103LDG

Scale 2/3

MCEN103LDG

On - Off

120mm

Blunt suction tube
with finger control

MCEN770B25	2.5mm
MCEN770B30	3mm

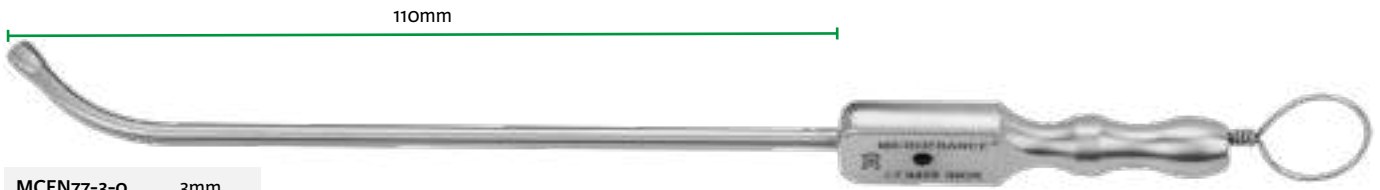

MCEN77-3-0	3mm
MCEN77-3-5	3.5mm

Jankowski

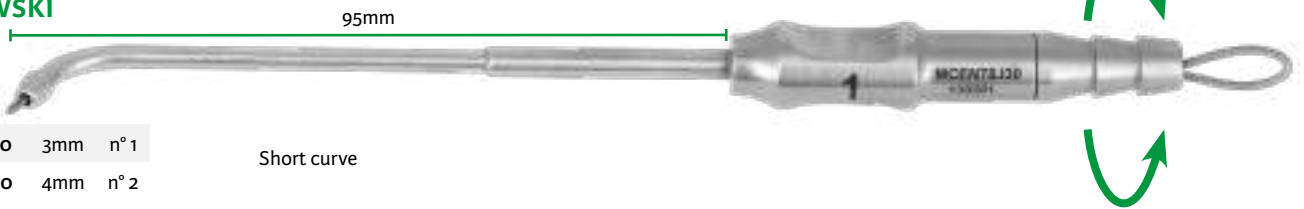

MCEN78J30	3mm	n° 1
MCEN78J40	4mm	n° 2

Short curve

Jankowski



Long curve

MCEN79J25	2.5mm	n°3
MCEN79J30	3mm	n°4
MCEN79J40	4mm	n°5

Orsel

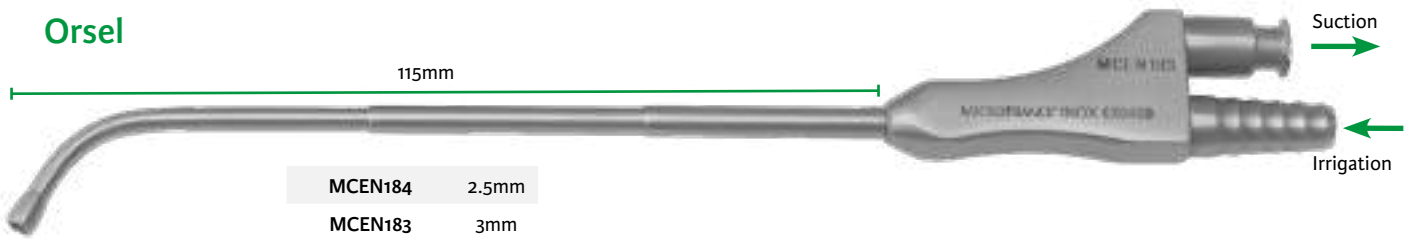

MCEN184	2.5mm
MCEN183	3mm

Orsel



MCEN186	2.5mm
---------	-------

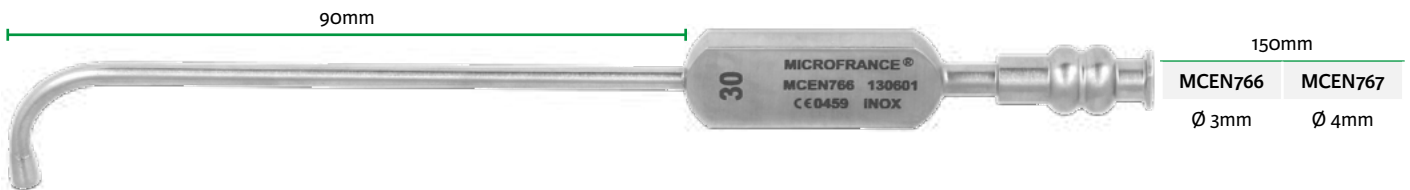

	150mm
MCEN766	MCEN767
Ø 3mm	Ø 4mm

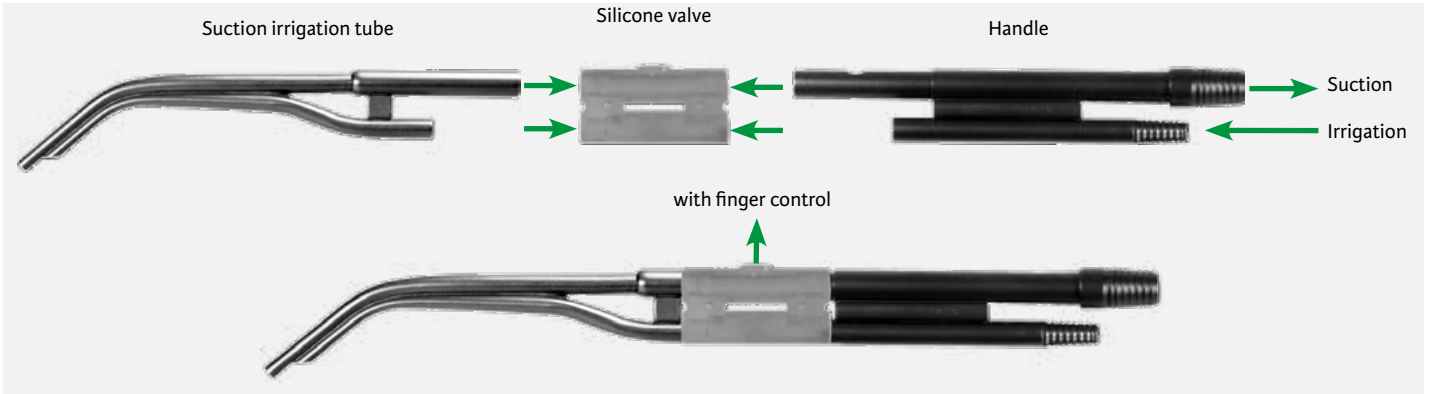

Handle
Delivered with silicone valve

1375012



Suction irrigation tube without hole

Reference	Working length	Size fr	Size mm
-----------	----------------	---------	---------

1375020	100mm	10X10	3.3 X 3.3
----------------	-------	-------	-----------



Suction irrigation tube with hole

Reference	Working length	Size fr	Size mm
-----------	----------------	---------	---------

1375025	100mm	10X10	3.3 X 3.3
----------------	-------	-------	-----------



1375101	90mm	5X4	1.7 X 1.4
----------------	------	-----	-----------



1375102	90mm	4X4	1.4 X 1.4
----------------	------	-----	-----------

1375103	90mm	4X3	1.4 X 1
----------------	------	-----	---------

1375107	90mm	7X7	2.3 X 2.3
----------------	------	-----	-----------

1375110	90mm	10X7	3.3 X 2.3
----------------	------	------	-----------

1375114	90mm	14X7	4.7 X 2.3
----------------	------	------	-----------

1375201	120mm	5X4	1.7 X 1.4
----------------	-------	-----	-----------

1375207	120mm	7X7	2.3 X 2.3
----------------	-------	-----	-----------

1375210	120mm	10X7	3.3 X 2.3
----------------	-------	------	-----------

1375214	120mm	14X14	4.7 X 4.7
----------------	-------	-------	-----------

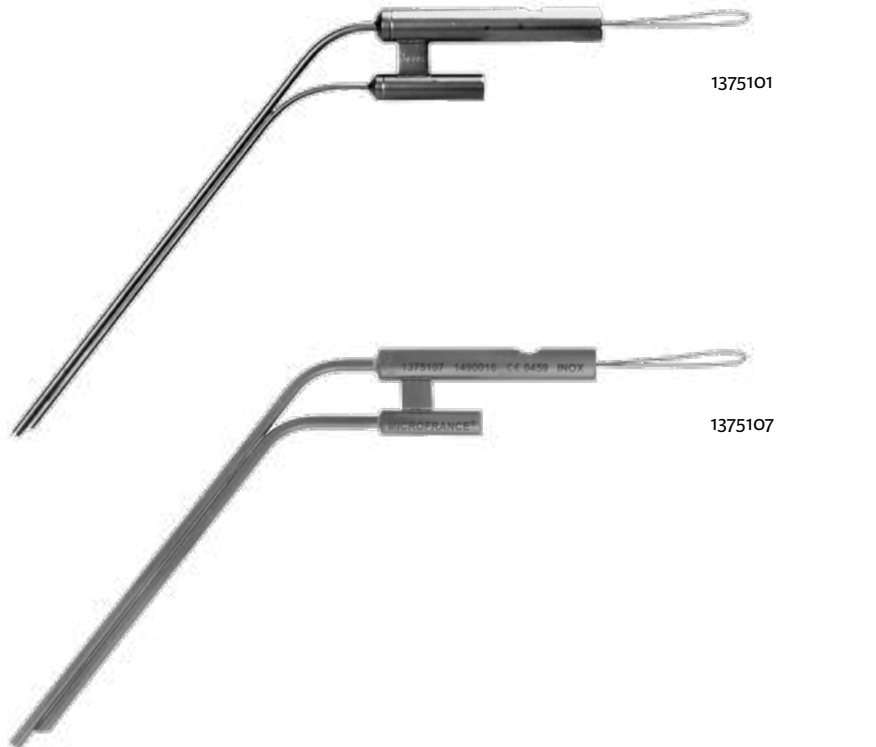

Dessi pump accessories



irrigation tubing Sterile,
disposable
single use

MCEN84S^(D)*

Pack 20

Used with irrigation pump
MCEN80**

Scale 2/3

Working length "L"

- 0° MCEN83-C
- 30° MCEN81-C
- 45° MCEN87C
- 70° MCEN82-C

MCEN82-C
L 150mm

Comeg



MCEN81O
L 140mm

Olympus



L 140mm

L 125mm

0°	MCEN83O	MCEN83OL	for scope (WA96200A)	-	-
30°	MCEN81O	MCEN81O1	(WA96201A)	MCEN81O2	for scope (WA96202A)
45°	-	MCEN87O3	(WA96203A)	MCEN87O4	(WA96204A)
70°	MCEN82O	MCEN82O5	(WA96205A)	MCEN82O6	(WA96206A)

- 0° MCEN83-S
- 30° MCEN81-S
- 45° MCEN87-S
- 70° MCEN82-S

MCEN83-S
L 150mm

Storz



- 0° MCEN83-W
- 25° MCEN81-W
- 30° MCEN81-W
- 45° MCEN87W
- 70° MCEN82-W

MCEN83-W
L 150mm

Wolf



Sleeve for variable scope

MCEN88SC

for scope : pattern :
Olympus WA9T400V
Sopro Comeg Ulyss

MCEN88SC
L 150mm

Sopro Comeg

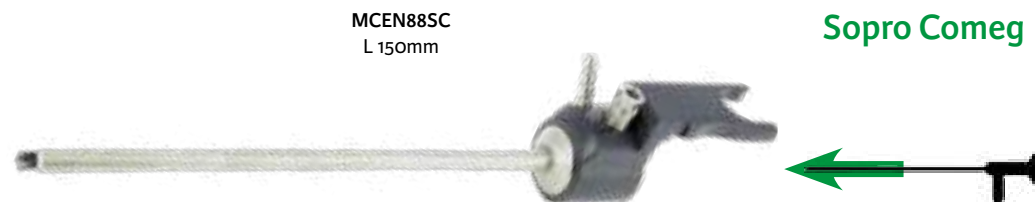

^(D) Distributed by Integra MicroFrance SAS (France) - For corresponding manufacturer part numbers, see table in annex

*Please check with your sales representative availability of this product in your country

** Reference discontinued

Scale 2/3

Working length "L"

Trocar and cannula

Rouvier

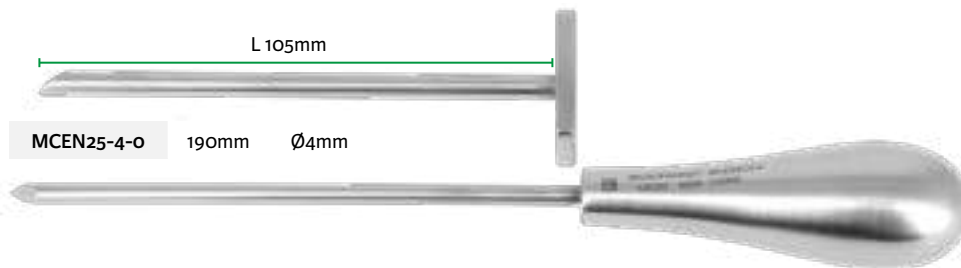

Biopsy cup forceps
for trocar MCEN25-4-0

MCEN28

Double-action jaws
2x5mm

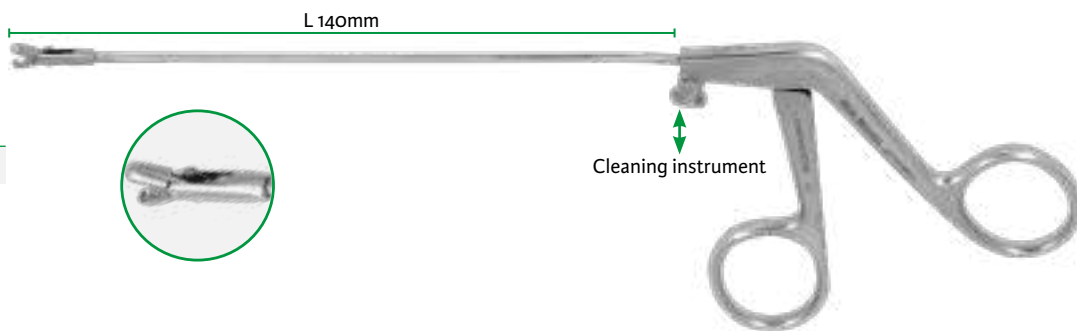

Albertini

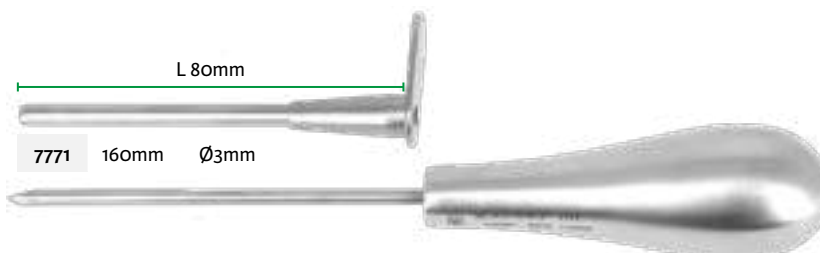

Irrigation tube guide

Albertini



^(D) Distributed by Integra MicroFrance SAS (France) - For corresponding manufacturer part numbers, see table in annex

Pradès

220mm

MCEN55

7,5mm



Gillies

230mm

3714379

7mm



Seeker



190mm

MCEN713

ball
Ø 2,3mm

Pick



160mm

1352431

Ø 0,6mm
"Mushroom" pick

Herman



235mm

MCEN127

Knife
4x5mm

Friedrich



180mm

MCEN44

Sickle knife
9mm

Rouvier



180mm

MCEN50

Dissector
and knife

Lérault



190mm

MCEN103

Angled
elevator
3mm

Scale 2/3

L 110mm

Working length "L"

Fenestrated cup jaws



MCEN33	MCEN34
3x6mm	3x6mm

Fenestrated cup jaws



MCEN90	MCEN91	MCEN91B
3x7mm	3x7mm	3x10mm

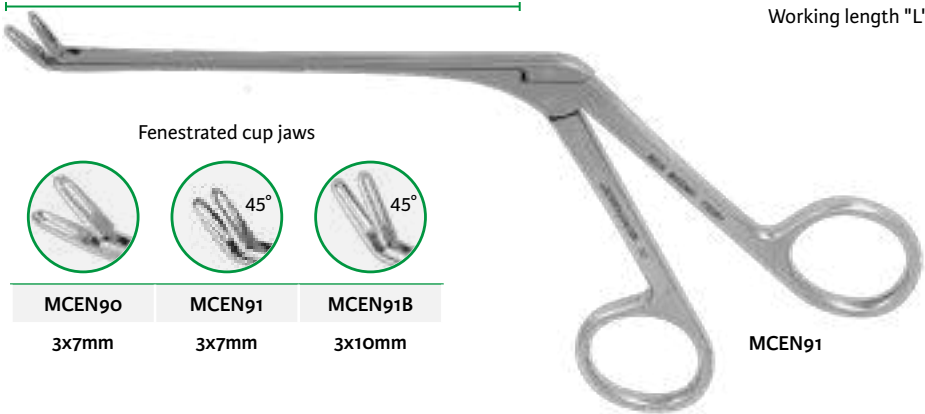

MCEN91

Blakesley-Klossek

Fenestrated cup jaws, 3mm



MCEN56	MCEN56-1
à droite	à gauche

Klossek

L 110mm

Suction

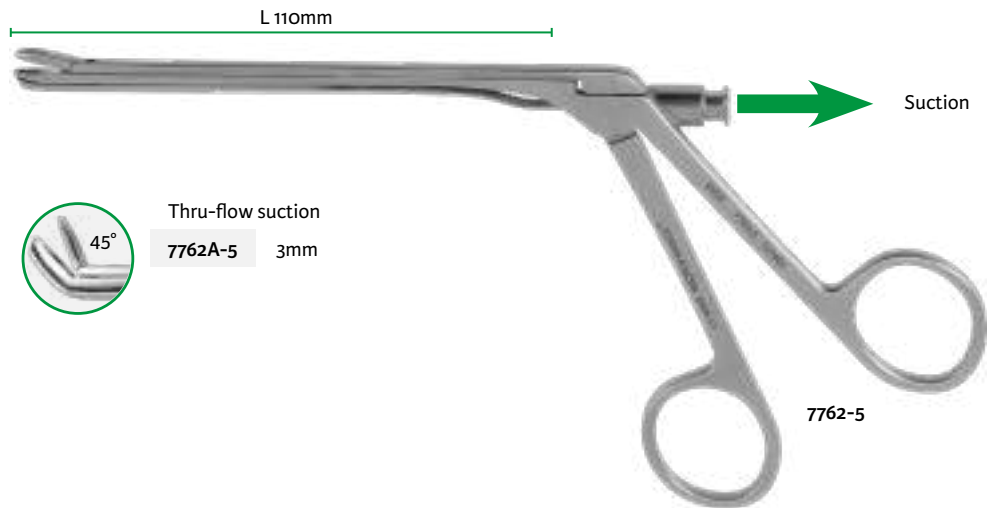

7762-5



Thru-flow suction	
7762-5	3mm



Thru-flow suction	
7762A-5	3mm

Dessi



L 125mm

Cleaning instrument

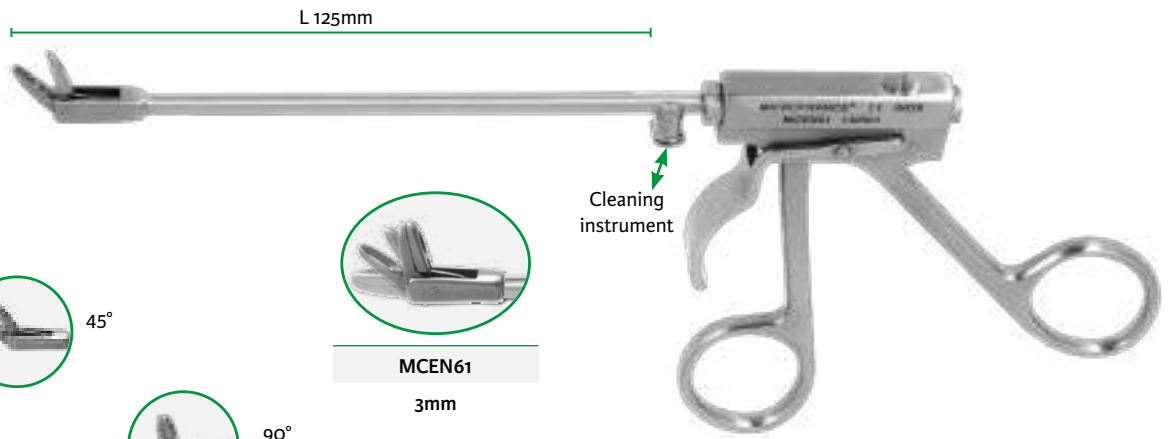

MCEN61
3mm

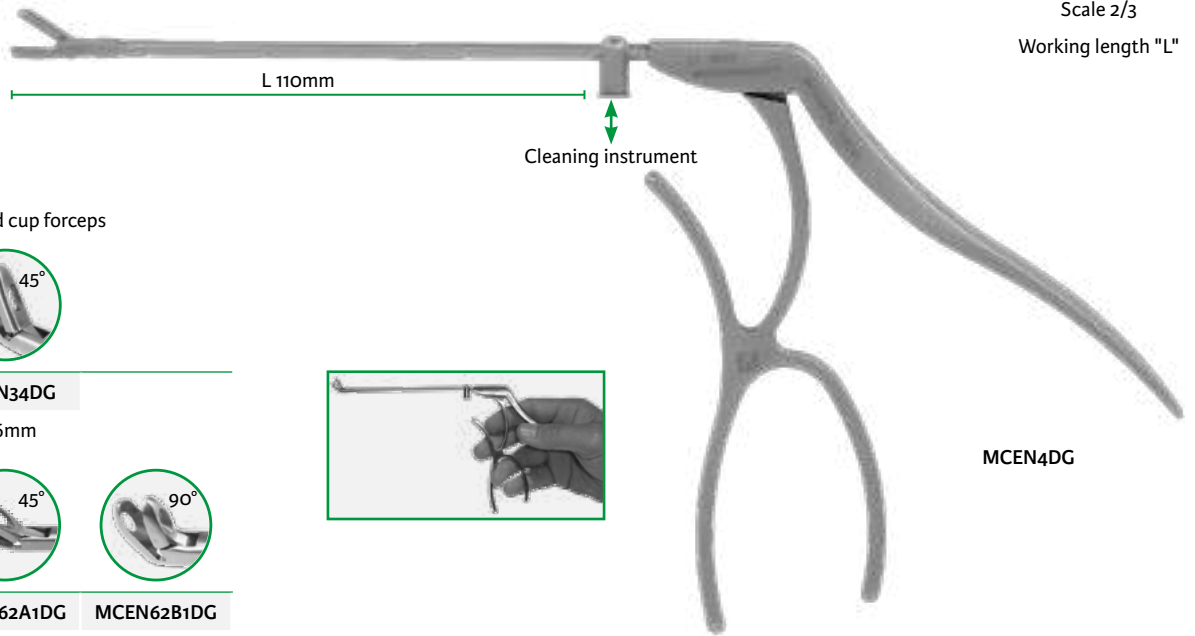

Fenestrated cup forceps



MCEN33DG
3x6mm



MCEN34DG
3x6mm



MCEN62T1DG
3x8mm



MCEN62A1DG
3x8mm

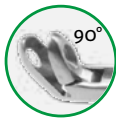

MCEN62B1DG
3x8mm



MCEN62T2DG
5x11mm



MCEN62A2DG
5x11mm

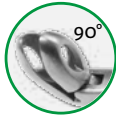

MCEN62B2DG
5x11mm



Fenestrated cup forceps



MCEN90DG
3x7mm



MCEN91DG
3x7mm



MCEN91BDG
3x10mm

Cup forceps



MCEN4DG
3x6mm



MCEN5DG
3x6mm

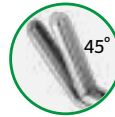

MCEN5BDG
3x12mm

Stylet handle for curette insert

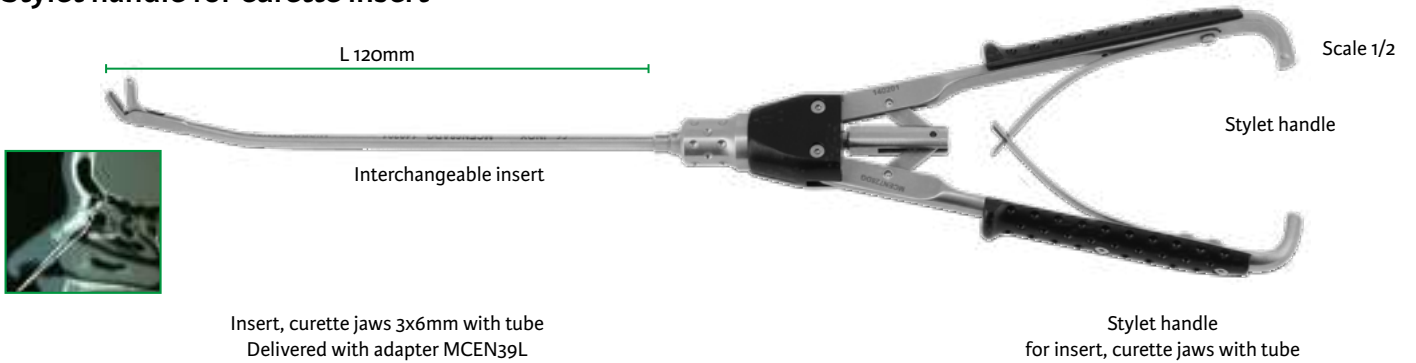

MCEN68CDG
Straight tube



MCEN68ADG
Insert 45°
angled tube



MCEN68BDG
Angled tube



Scale 1/4



MCEN728DG



MCEN39L

Scale 1/2

Adapter luer-lock for tube insert cleaning port - Pack 3

Scale 2/3

Working length "L"

Fenestrated cup forceps

Straight 45° 90°



jaws 3x8mm

MCEN62T1 MCEN62A1 MCEN62B1



jaws 5x11mm

MCEN62T2 MCEN62A2 MCEN62B2



jaws 6x11mm

MCEN62T3 MCEN62A3 MCEN62B3



jaws 4x17mm

7762A4

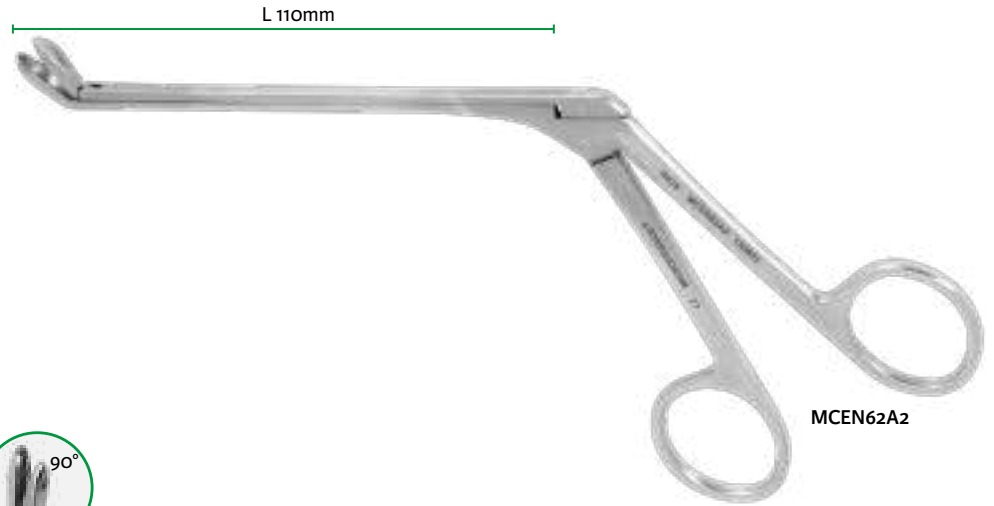

MCEN62A2

Cup forceps, curved up



Curve	Horizontal opening	Vertical opening
70°	MCEN350H	MCEN350V
100°	MCEN360H	MCEN360V

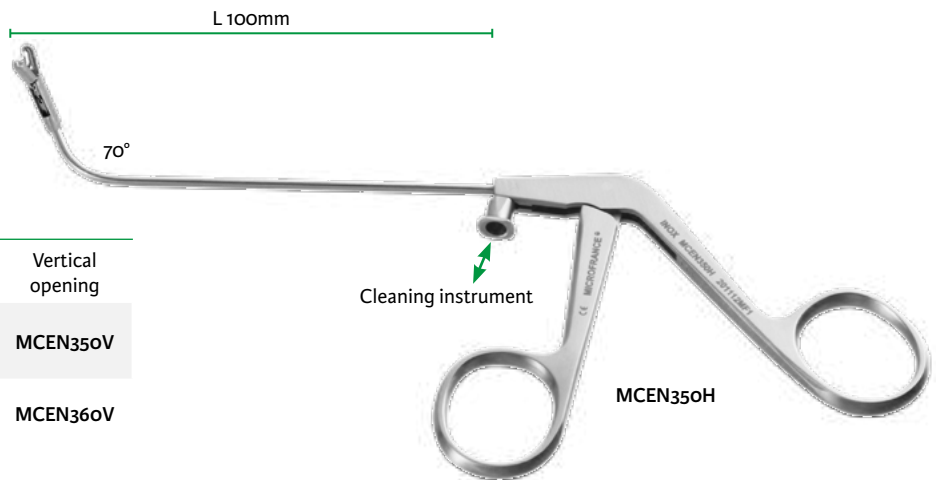

MCEN350H

Cup forceps, curved up, pear jaws



MCEN960H

curve 80°

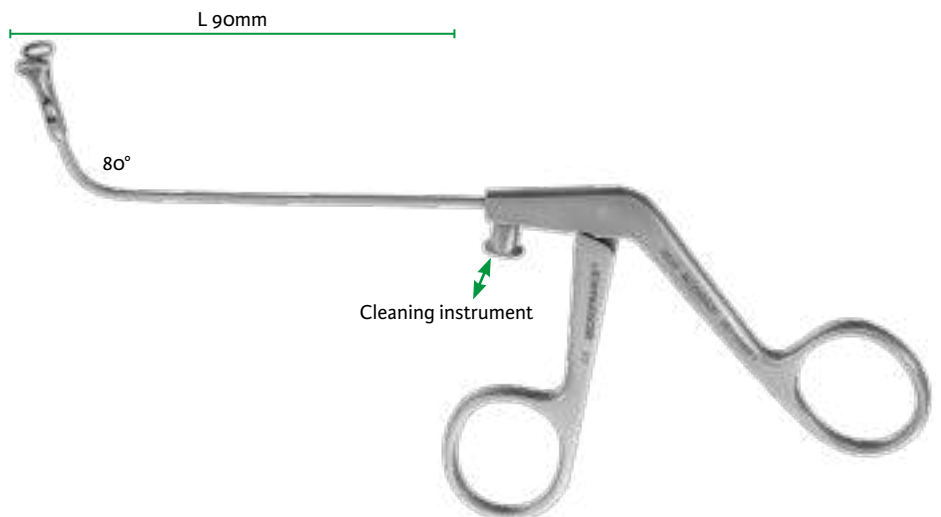

Rouvier



MCEN4
3x6mm



MCEN5
3x6mm

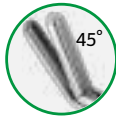

MCEN5B
3x12mm



MCEN43
1x4mm
30°



MCEN3
2mm

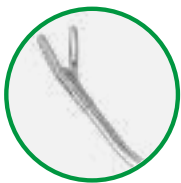

MCEN29
2x5mm
45°
right vertical
opening

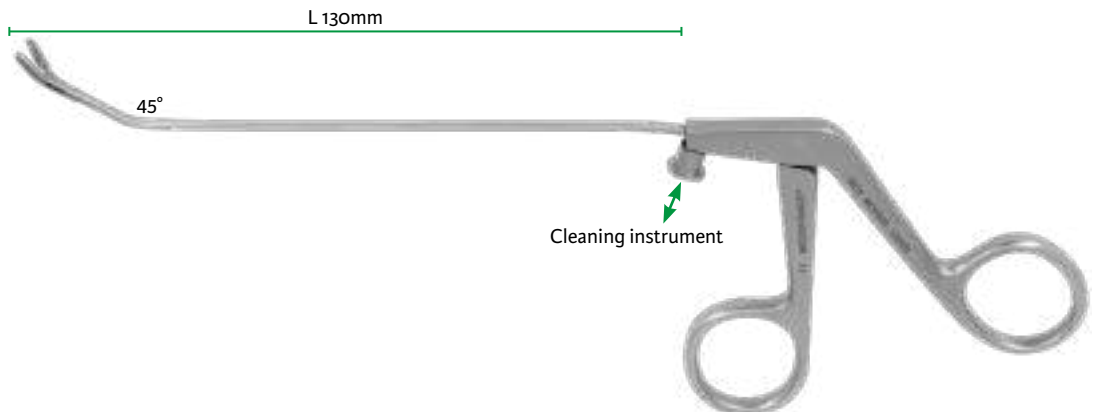
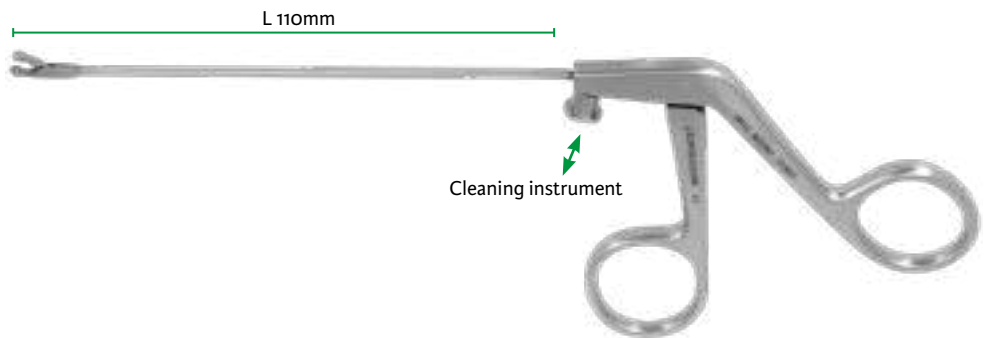
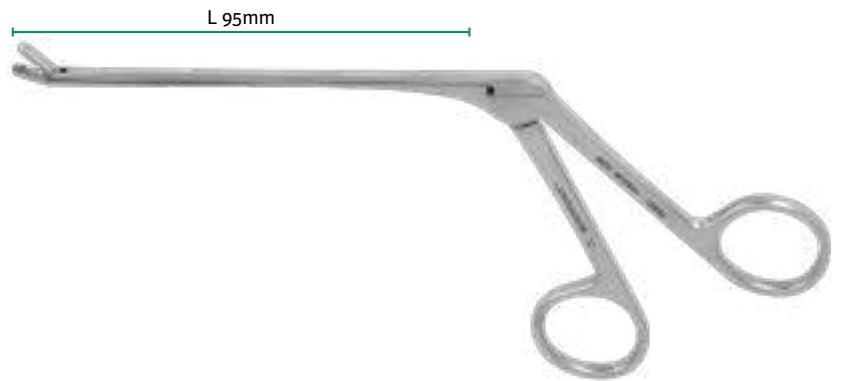

Fenestrated cup forceps

Weil-Blakesley

Blakesley

Straight

45°

90°



7762-1

7762A-1

7762B-1

Jaws 3mm

Weil-Blakesley



7762-2

7762A-2

3.5mm jaws



Scale 2/3

Working length "L"

Fenestrated cup forceps
Jaws 2mm

straight 45°

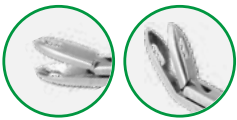

7763

7763-1

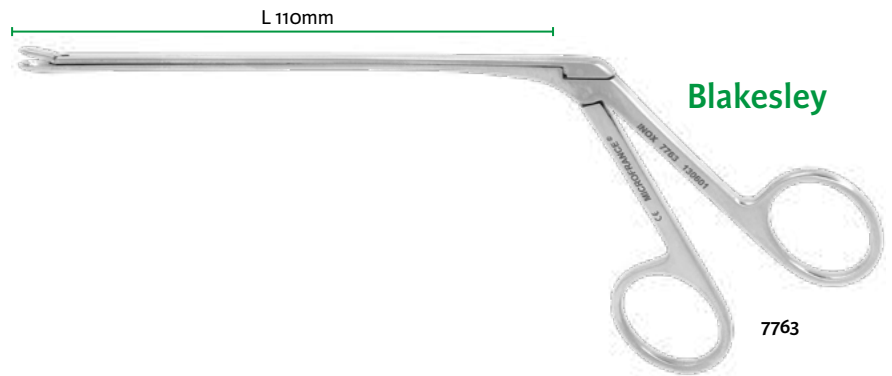

Blakesley

7763

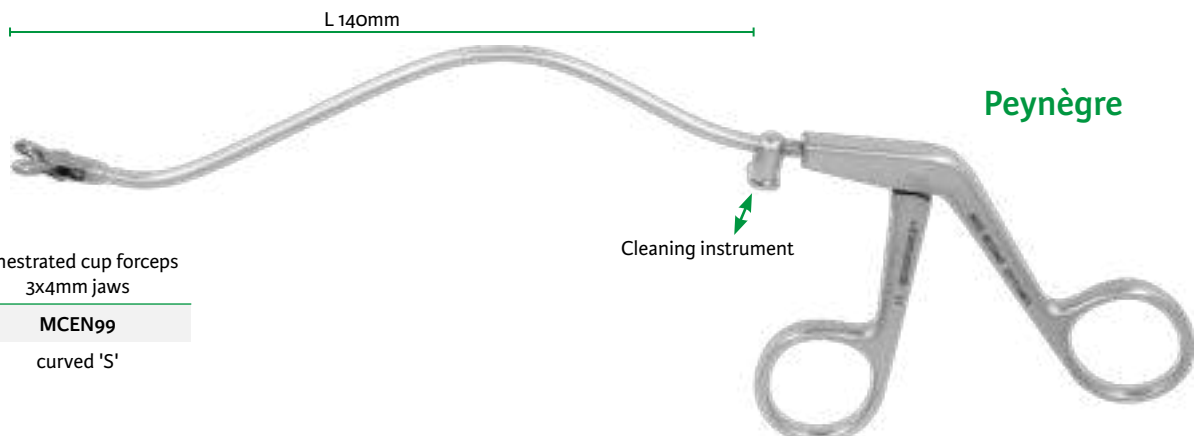
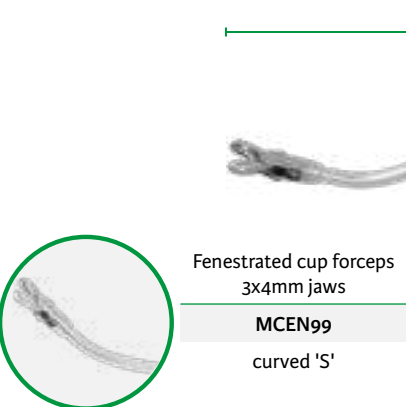
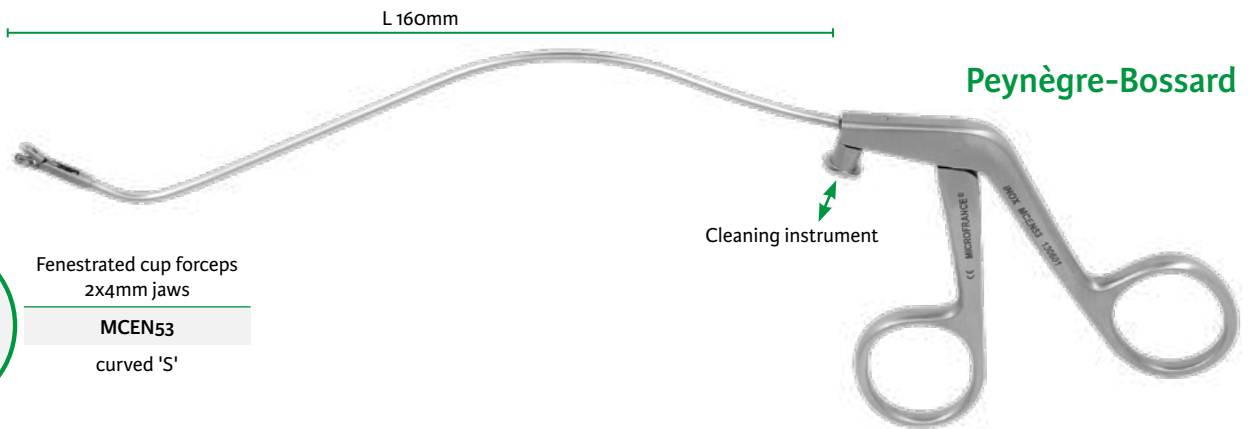
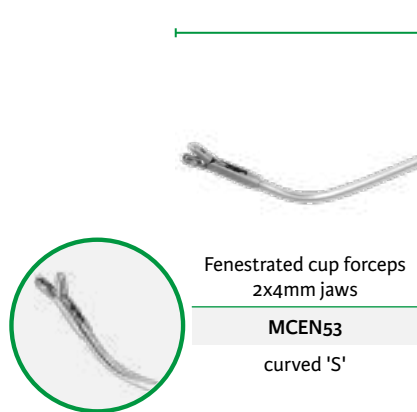
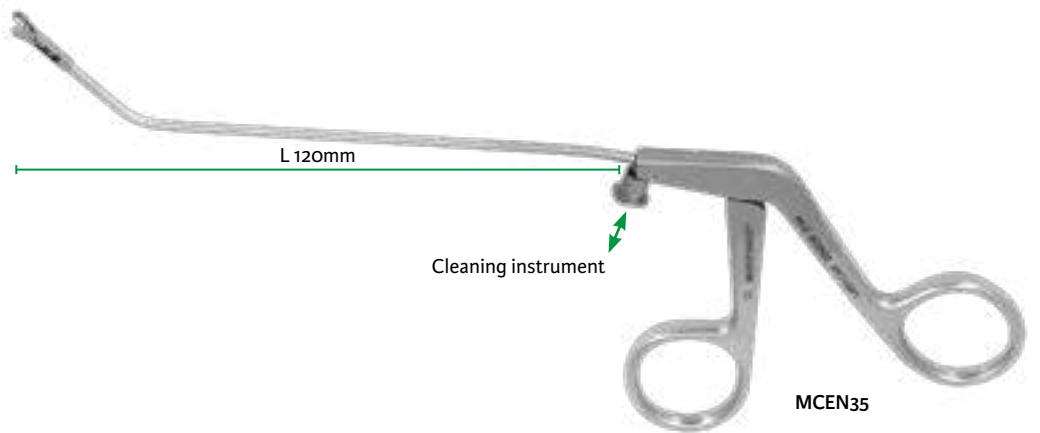
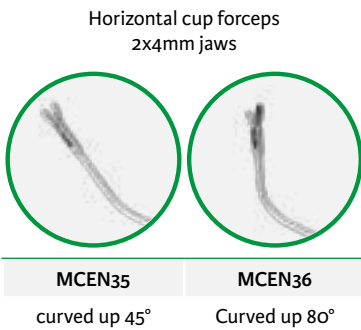
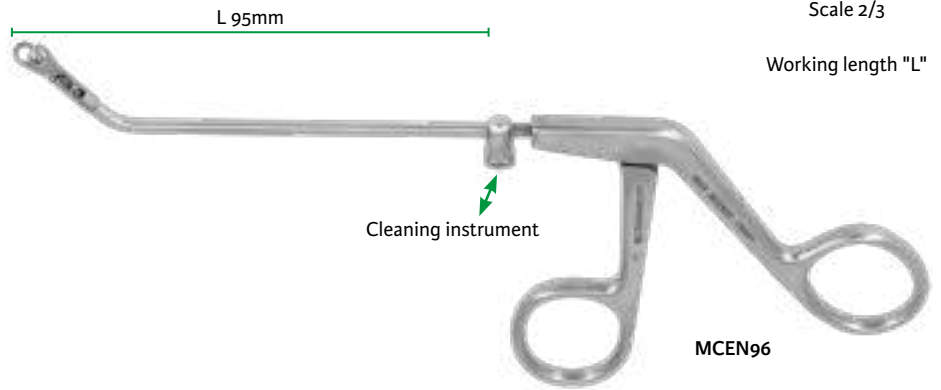
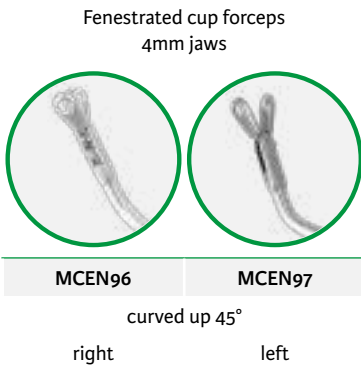

Scale 2/3

Working length "L"

Orsel

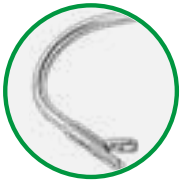

3x4.5mm Jaws

MCEN68

Curved down 130°

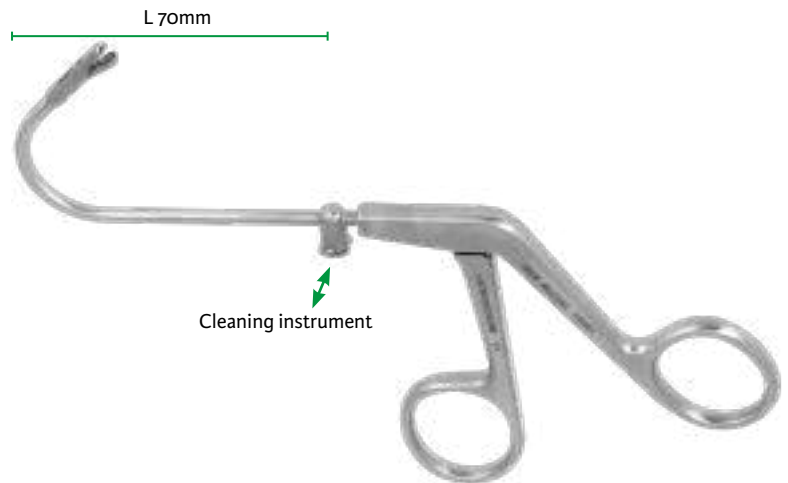

Terrier

curved down

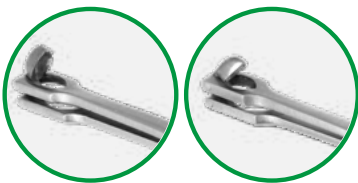

MCEN27-1

3x6mm jaws
L 100mm

MCEN27

4x7mm jaws
L 120mm

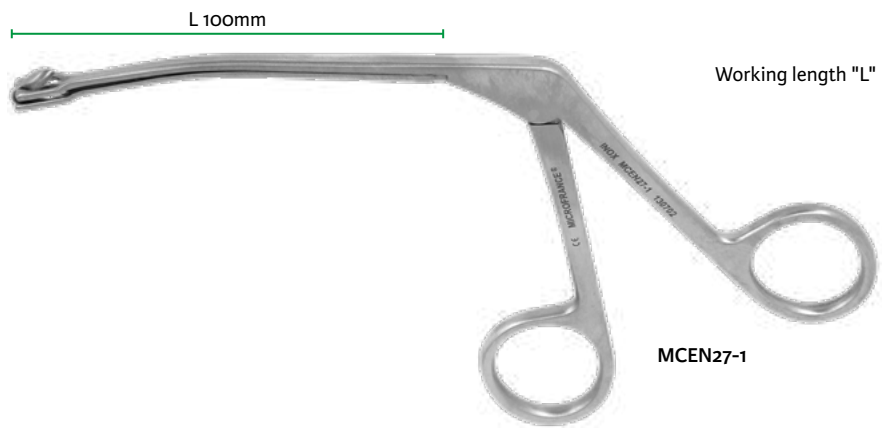

rotatable 360°

MCEN27R

2.5x7mm jaws

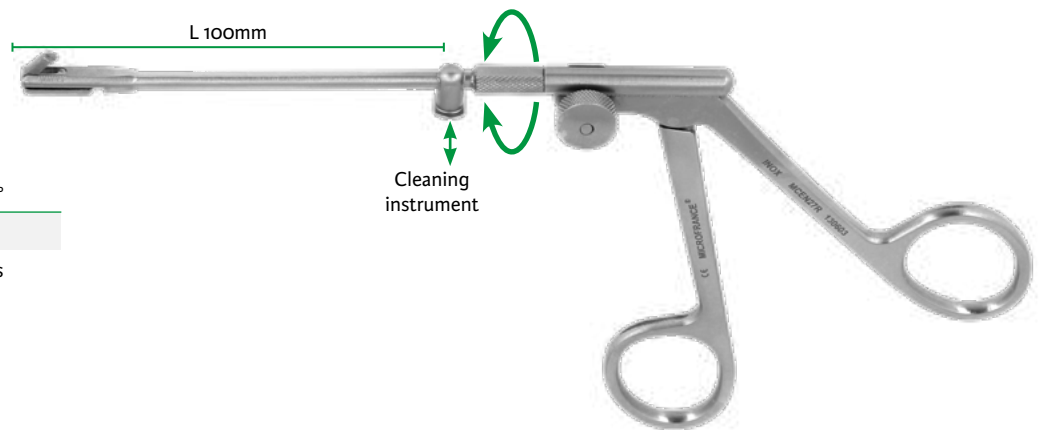

Terrier

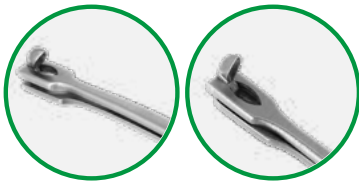

Jaws 2x4mm

MCEN27-2	MCEN27-3
curved down	curved up

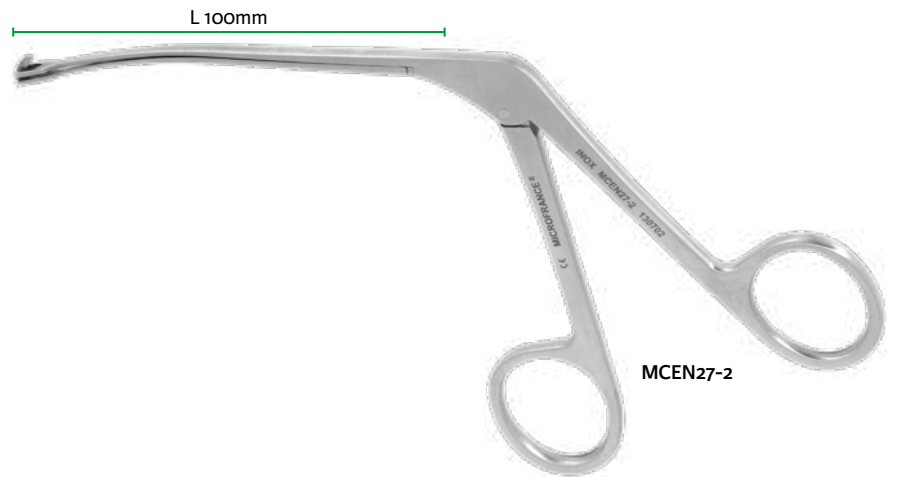

MCEN27-2

Terrier

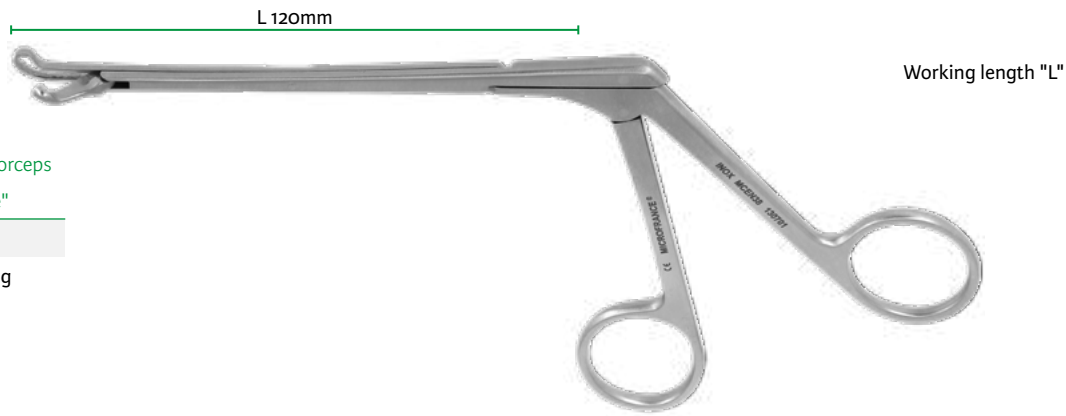

Punch cutting forceps
"Joséphine"
MCEN38
left opening

Rouvier

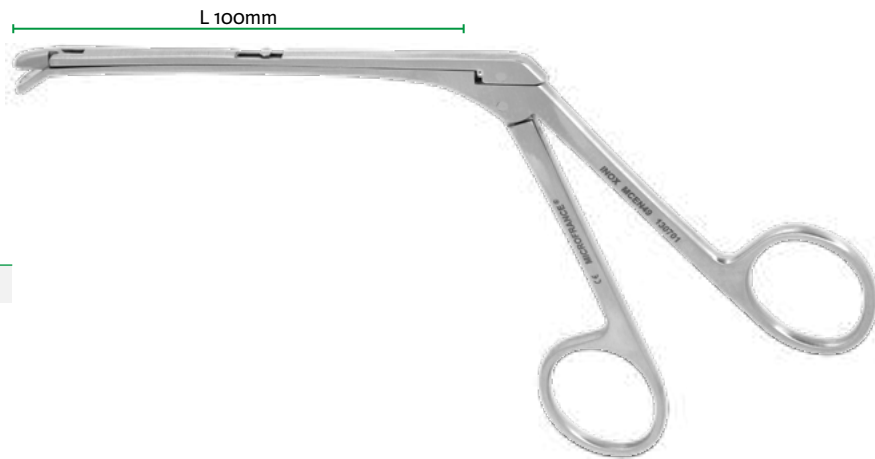

Backbiting punch
down 30°
MCEN49
jaws 4mm

Scale 2/3

Working length "L"

Struycken

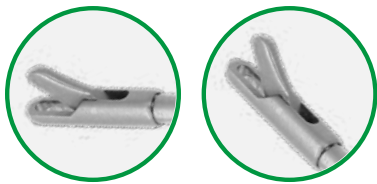

MCEN65	MCEN66
1,5mm straight	1,5mm up 45°

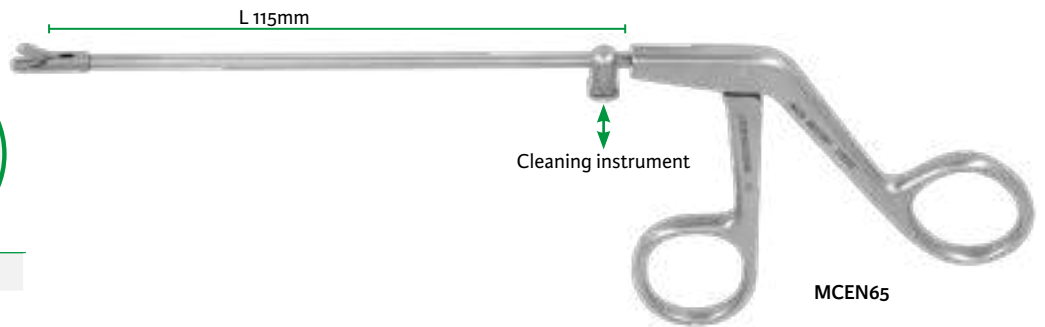

Struycken

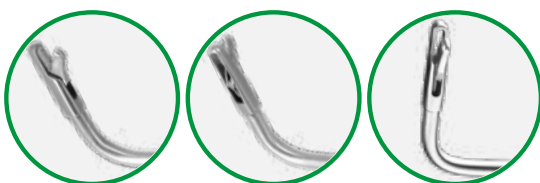

L 115mm		
MCEN67	MCEN67-1	MCEN67-2
1,5mm	right opening	left opening



Citelli-Peynègre

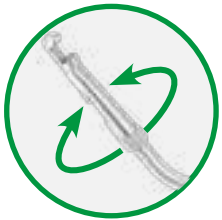

MCE98

3mm

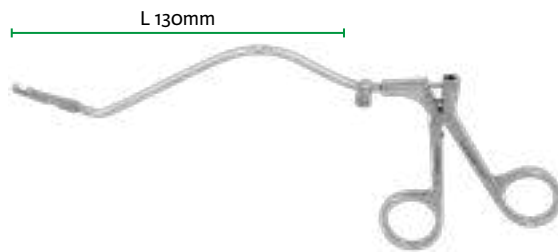

Working length "L"

Citelli-Frèche



MCE12

4mm - 45°

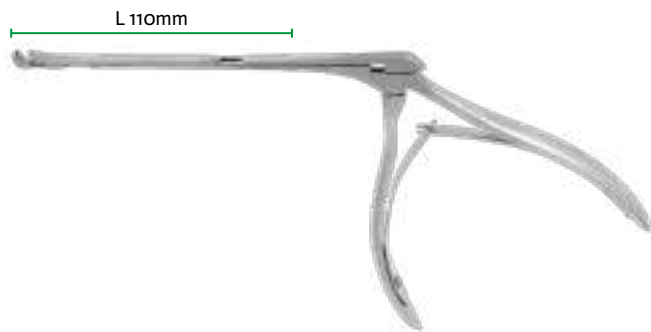

Scale 1/2

Jankowski

Titanium serrated blades 15mm



MCEN41J

Straight

MCEN42J

Curved left

MCEN42J1

Curved right

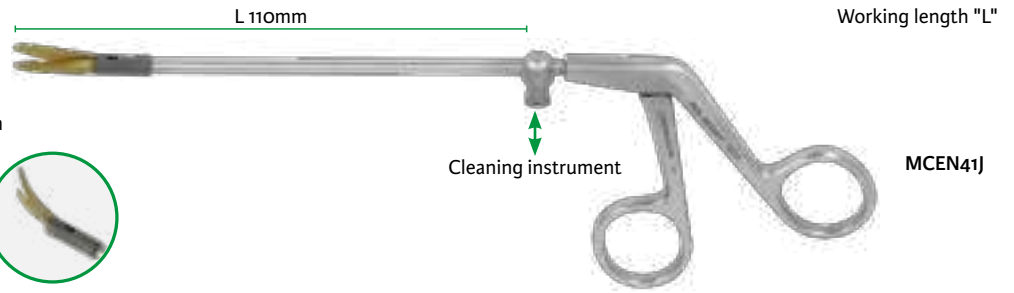

Working length "L"

MCEN41J

Dessi

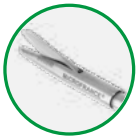

MCEN41D3

Serrated blades 10mm

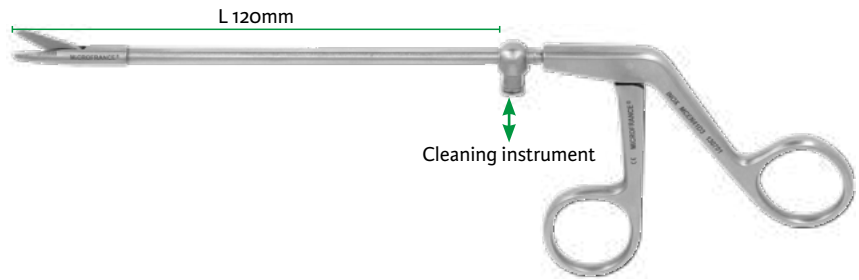

L 120mm

Cleaning instrument

Peynègre



Serrated blades 10mm

MCEN41-1

Straight

MCEN42

Curved left

MCEN42-1

Curved right

Rouvier



L 100mm

MCEN41-1

Scale 1/2

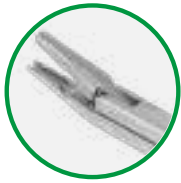

MCEN21
Clip LT200

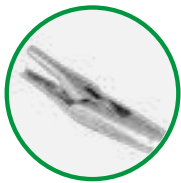
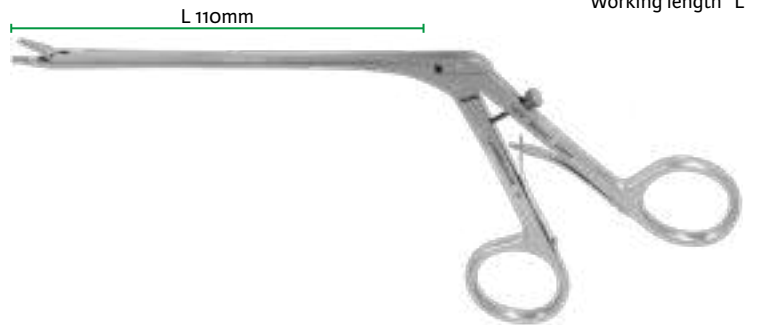

MCEN21R
Clip LT200

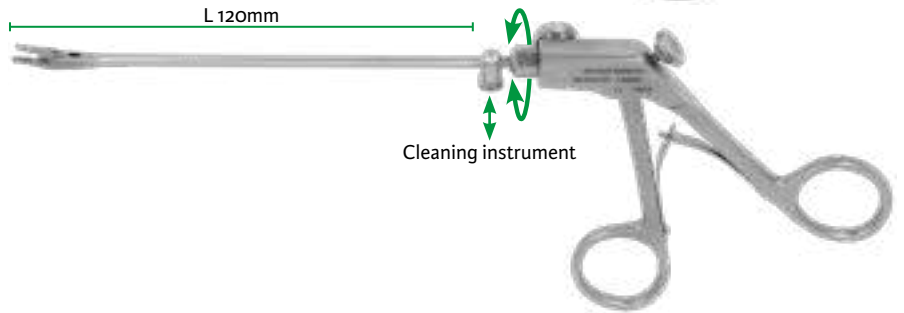

Wormald



MCEN211
Clip LT200

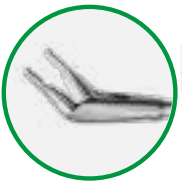

MCEN211S
Clip LT100

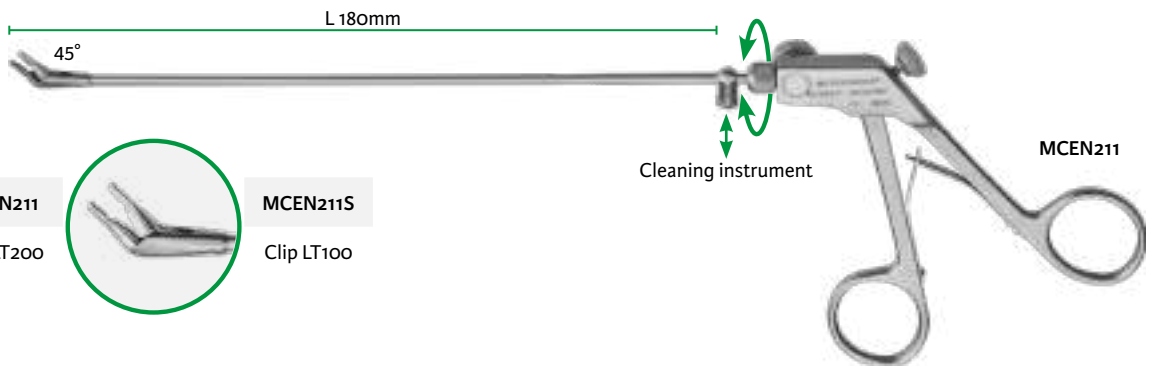

Wormald



MCEN212
Clip LT200

MCEN212S
Clip LT100

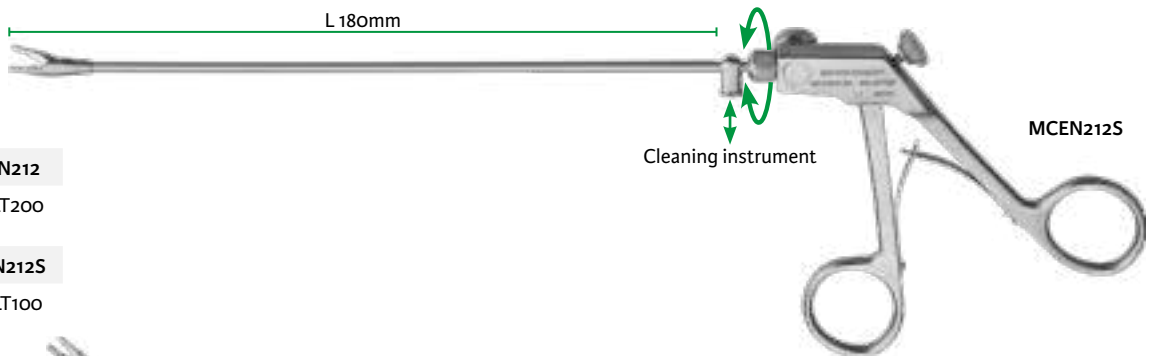

Wormald



MCEN213
Clip LT200

MCEN213S
Clip LT100

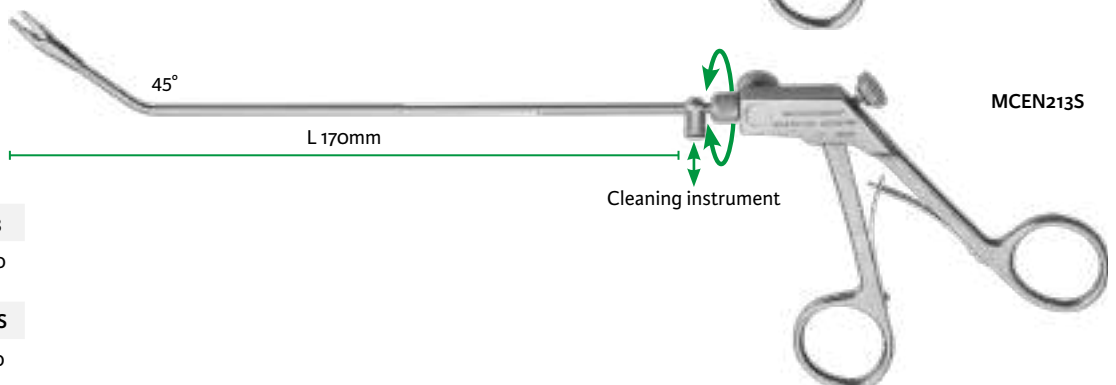

Bipolar forceps, 1 piece instrument

Scale 2/3

Dessi

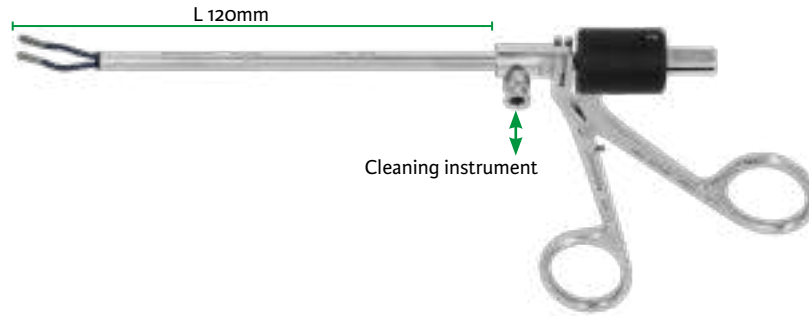

Working length "L"

MCEN54

Bipolar forceps, 3-piece instrument

Dessi

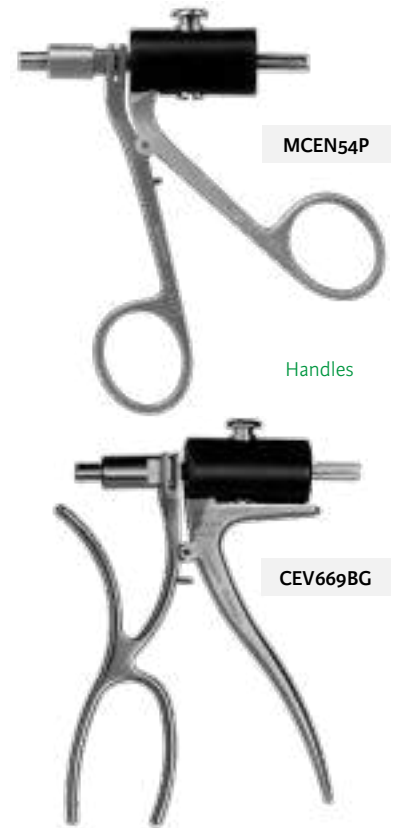
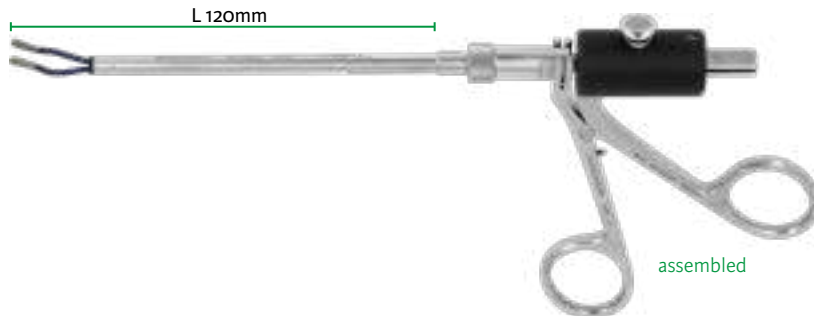

MCEN54G



Tube

MCEN54I



Insert

MCEN54H



Herman
Insert

Bipolar cables - 4,5 m

CP393-2
Bowa Emc Lamidey Valleylab

CP393-3
Erbe VIO ICC ACC (except international) Storz Wolf

CP393-4
Aesculap Berchtold Martin
Sutter BM-780 II

Scale 1/2

Working length "L"

Wormald

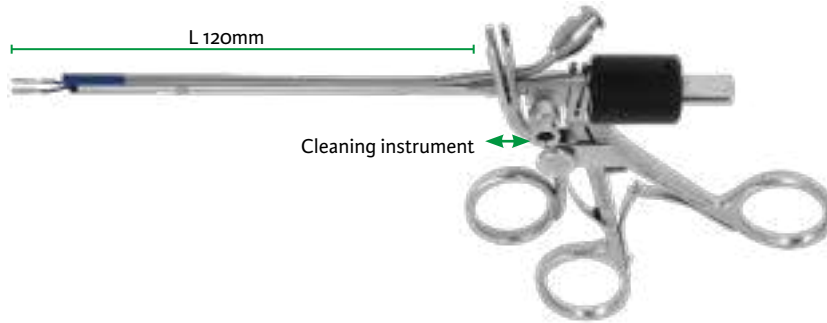

MCEN64

Wormald

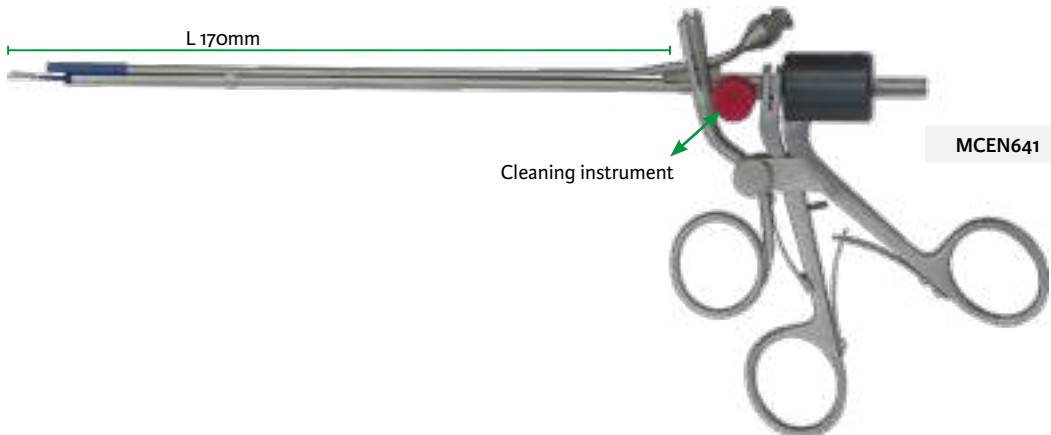

MCEN641

Wormald

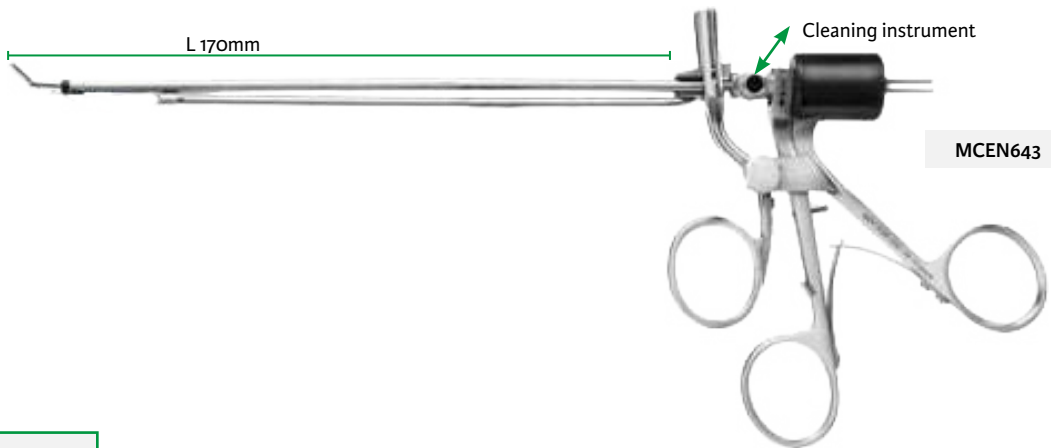

MCEN643

Bipolar cables - 4.5 m

CP393-2
Bowa Emc Lamidey Valleylab

CP393-3
Erbe VIO ICC ACC (except international) Storz Wolf

CP393-4
Aesculap Berchtold Martin Sutter BM-78o II



Hook

Working length "L"

Scale 1/2

Frèche



90°

L 70mm



200mm

MCEN101

Herman



90° - 5mm

L 125mm



245mm

MCEN128

Suction tube elevator with finger control

Appelbaum



Ø2mm

L 65mm



170mm

MCEN730

Suction tube with finger control

Frèche

MCEN100-2-0 2mm

MCEN100-2-5 2.5mm

MCEN100-3-0 3mm

MCEN100-3-5 3.5mm

L 145mm



200mm

MCEN100-2-5

Lancet knife

Frèche



L 140mm



260mm

MCEN105

Picks

Rouvier



L 110mm



220mm

MCEN11

Rouvier



L 110mm



220mm

MCEN102

with suction

Monopolar cables - 3.5 m



CP391E

Erbe ACC ICC/VIO Storz Wolf



CP391M

Aesculap Berchtold Martin Erbe T Serie
Lamidey Sutter BM-780 II



CP391V

Bowa Bovie Conmed Valleylab

Drill with adjustable thrust



Scale 1/1 **7777** 85mm Ø 2mm

Nail

Working length "L"

Lemoine



7778
L 15mm



7778-1
L 10mm

Scale 1/1

Klossek



7778K
L 15mm



7778K1
L 10mm

Kennedy Instrumentation - 150mm length

Kennedy

Working length "L"

Scale 1/1

L 105mm

Malleable



Palpation probe

MCSK1



Sharp hook

MCSK2



Blunt hook - 90°

MCSK3



Blunt hook - 150°

MCSK4



Curette - 1mm

MCSK6



Suction tube - 2mm

MCSK5

Knife and suction tube

Scale 1/2

Working length "L"



MCEN111
205mm



MCEN111	MCEN112	MCEN120
4mm - 80°	4mm - 90°	4mm - 135°

Thru-flow suction cup forceps

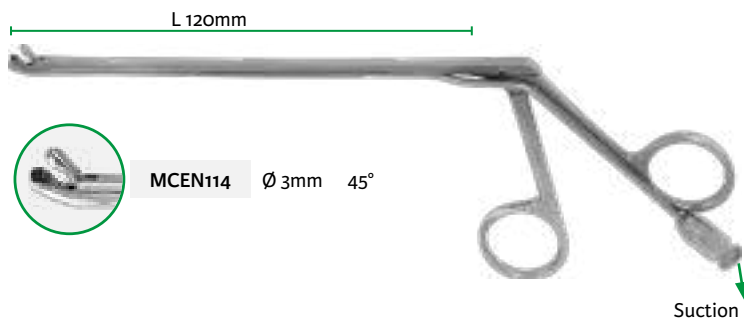

MCEN114 Ø 3mm 45°

Suction

Suction tube with finger control 170mm length

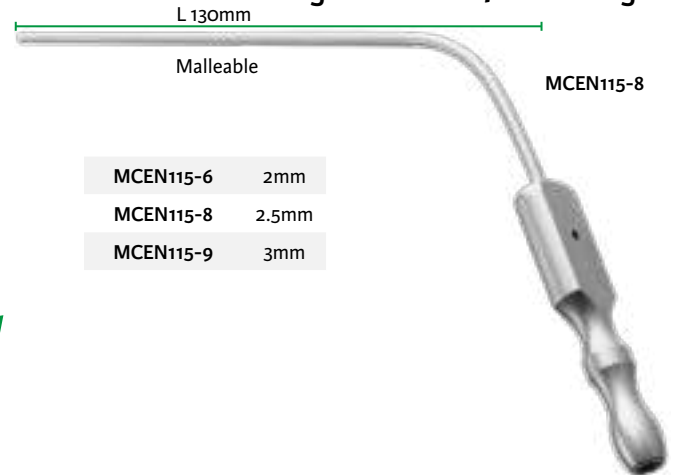

MCEN115-6	2mm
MCEN115-8	2.5mm
MCEN115-9	3mm

Cutting circular punch

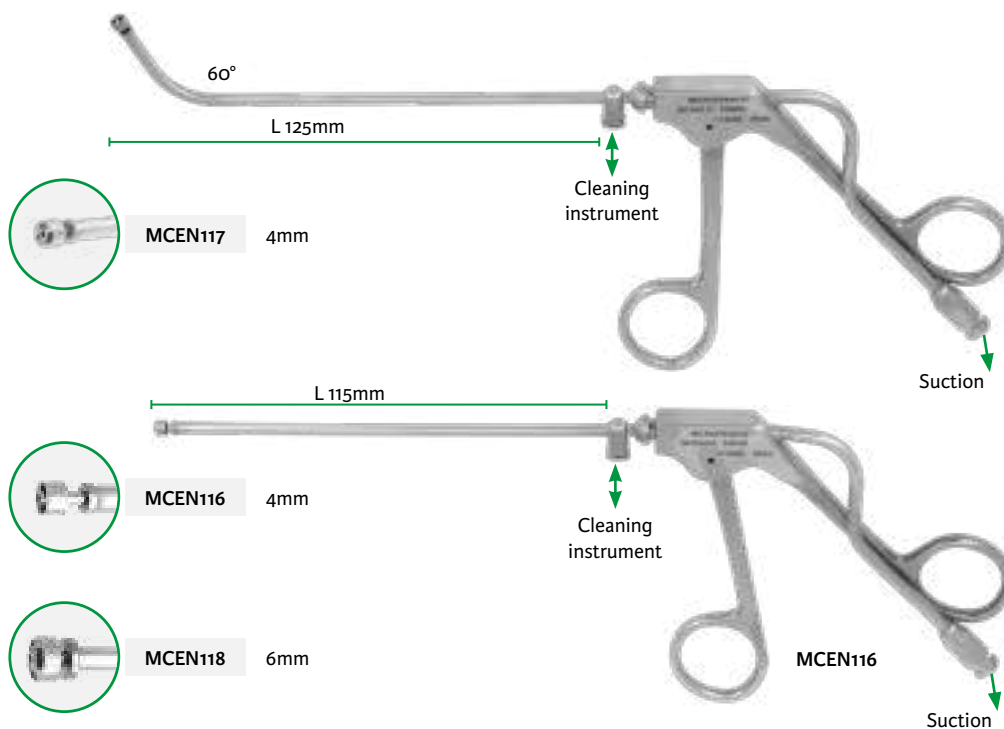

MCEN117 4mm



MCEN116 4mm



MCEN118 6mm

Cleaning instrument

Cleaning instrument

Suction

Suction

MCEN116

Scale 2/3

Suction curette with finger control

Working length "L"

150mm - Ø 3.5mm

MCEN768 Curette 90°

MCEN769 Curette 60°

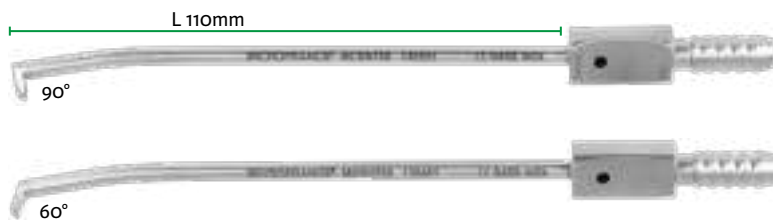

Double knife

190mm

MCEN720



240mm

MCEN760



240mm

MCEN761



Double palpation probe, Double ended seeker

Double-ended seeker

195mm

MCEN721



190mm

MCEN723



Double-ended palpation probe

245mm

MCEN762



245mm

MCEN763



Angled palpation probe



MCEN155 180mm

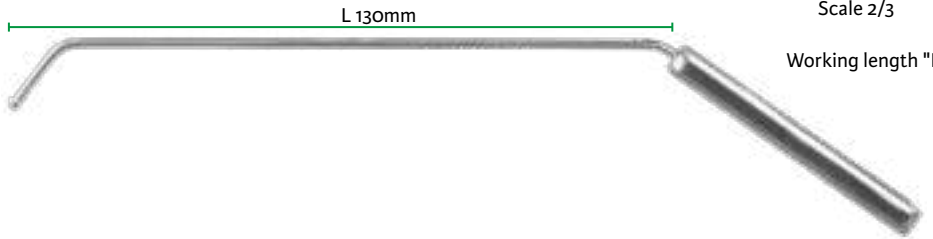

Scale 2/3
Working length "L"

Angled elevator



MCEN157 180mm

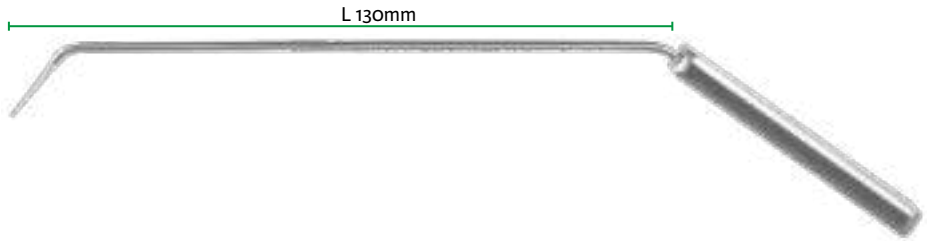

Blunt suction tube



MCEN156 185mm
Ø 2mm

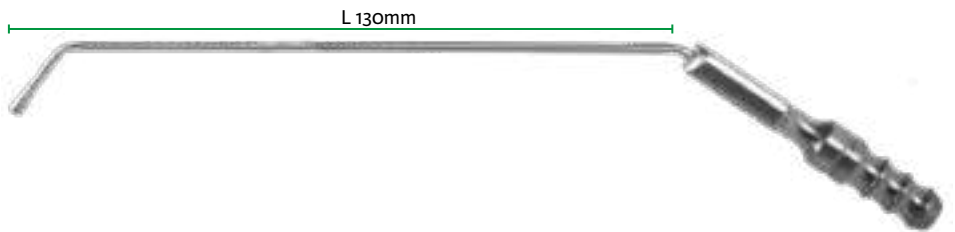

Angled suction tube elevator

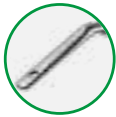

MCEN158 185mm
Ø 2mm

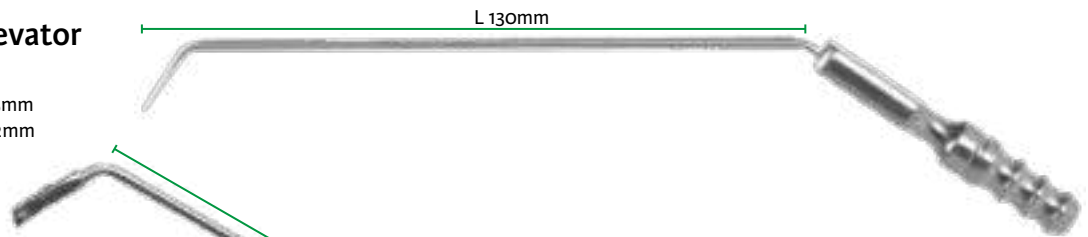

Cup forceps

curved down 45°



MCEN151
vertical



MCEN152
horizontal

Thru-cutting forceps



MCEN153
vertical



MCEN154
horizontal



MCEN153

Scale 2/3

Working length "L"

Blunt loop, Knife and suction tube, suction curette

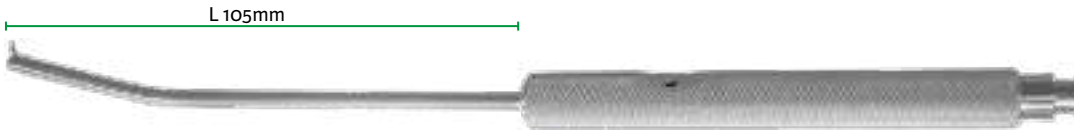

210mm
MCEN165



Blunt loop



Knife and suction tube

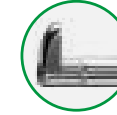

Suction curette

MCEN161	MCEN163	MCEN164	MCEN165	MCEN167
135° - Ø 3mm	90° - Ø 3mm	135° - Ø 3mm	45° - Ø 3mm	90° - Ø 3mm

Knife, Sickle knife, Loop, curved shaft



MCEN168



Knife
90°



Sickle knife
curved



Blunt loop
70°

MCEN162	MCEN168	MCEN170
180mm	225mm	250mm

Double ended perforator elevator



250mm
MCEN171

Perforator

Elevator

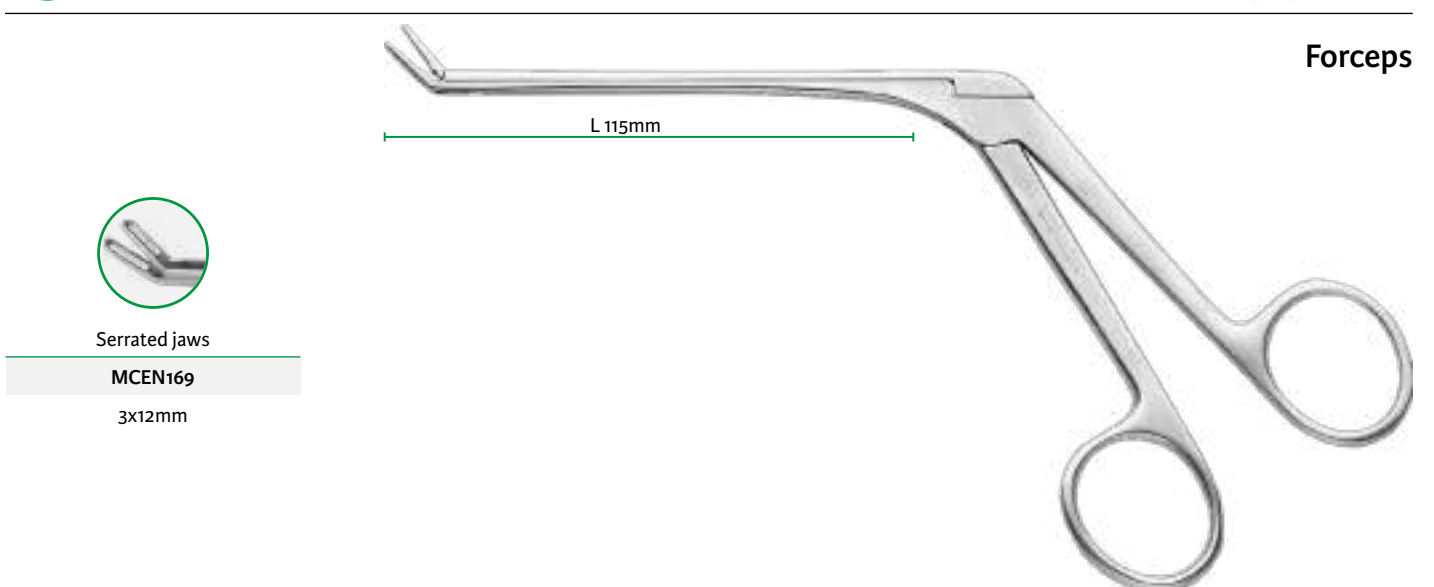

Forceps



Serrated jaws

MCEN169
3x12mm

Palpation probe, Suction tube, Suction tube elevator

Scale 2/3

Working length "L"

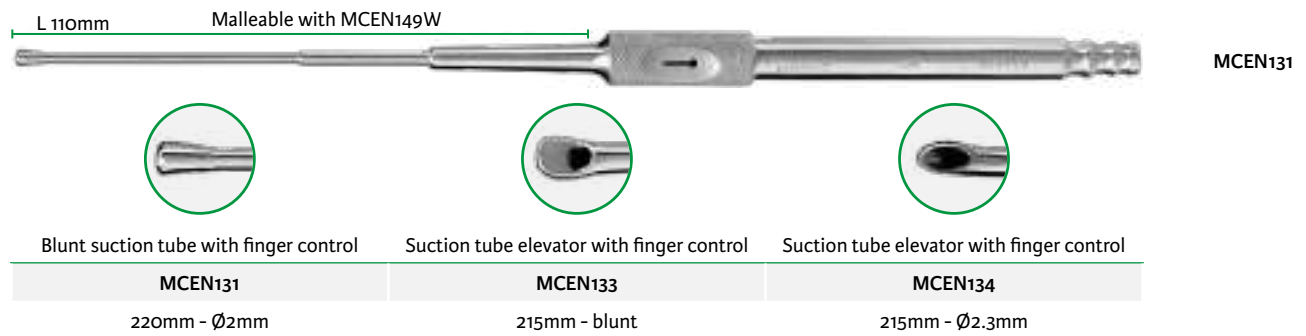

Knot pusher



Scale 1/2

Palpation probe, Suction curette, Basket suction tube, Suction tube elevator

Working length "L"

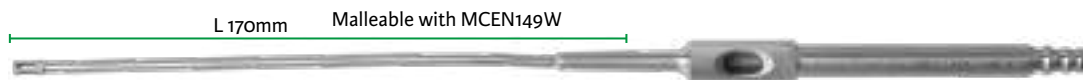

MCEN142

Suction tube with finger control

Suction curette with finger control

Basket suction tube with finger control

Suction tube elevator with finger control



MCEN138	MCEN138S	MCEN140	MCEN140A	MCEN141	MCEN141A	MCEN142	MCEN147
Ø 3.5mm	Ø 2mm	Ø 2.5mm	Ø 2.5mm	Ø 2.5mm	Ø 2.5mm	Ø 2.5mm	Ø 2.5mm
		45°	45°	90°	90°		
		4x5mm	5x6mm	4x5mm	5x6mm		

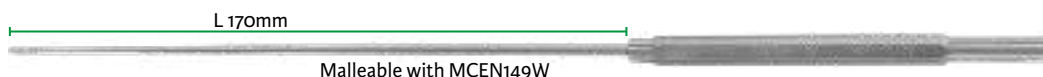

MCEN139A

Palpation probe



MCEN139	MCEN139A
90°	Straight



Suction tube modelling lever

MCEN149W

150mm

Scissors, forceps

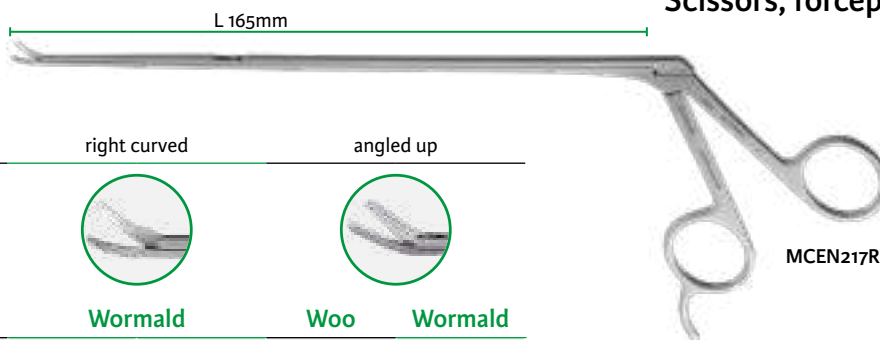

MCEN217R

Scissors

straight

left curved

right curved

angled up



Woo Wormald Woo Wormald Woo Wormald

MCLW10	MCEN217S	MCEN216L	MCEN217L	MCEN216R	MCEN217R	MCLW11	MCEN217U
5mm	8mm	5mm	8mm	5mm	8mm	5mm	8mm

Fenestrated cup forceps, 230mm



MCEN214	MCEN215
straight jaws	45° jaws
1.5x3.5mm	1.5x3.5mm

Needle-holder, tungsten jaws

Scale 1/2

Working length "L"

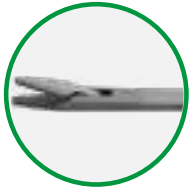

MCEN218

tungsten

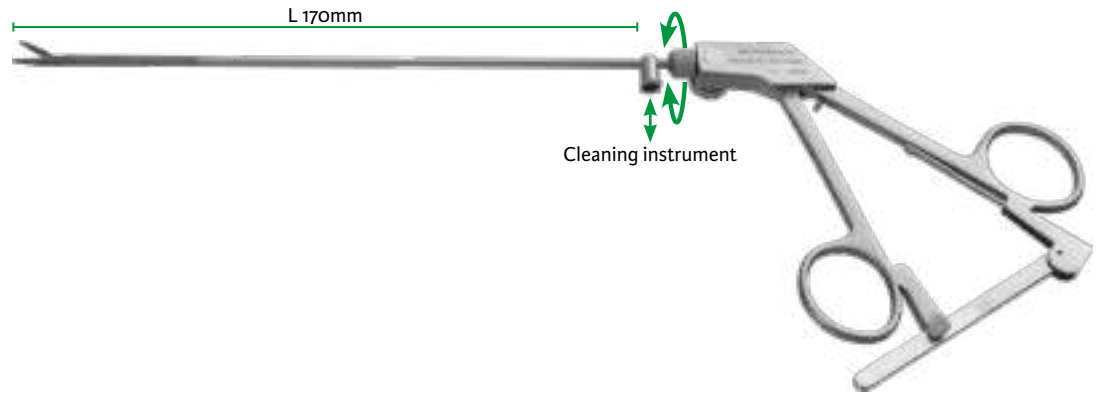

Debaquey clamp, rotatable



MCEN191



MCEN192

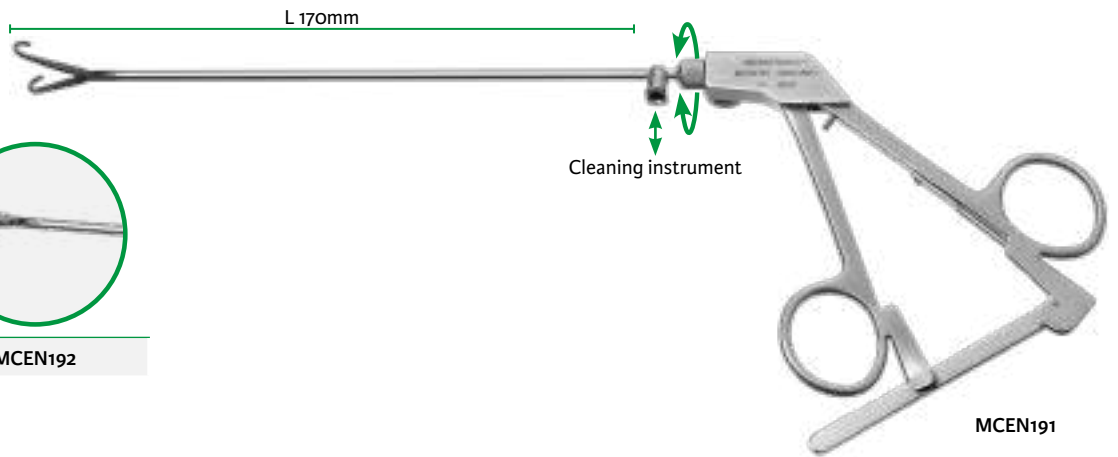

MCEN191



MCEN190

Straight, angled shaft
20°



MCEN193

Straight, angled shaft
45°

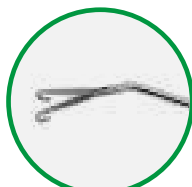

MCEN194

Curved, angled shaft
45°

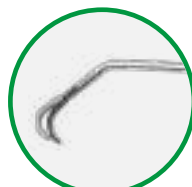

MCEN195

Curved, angled shaft
45°

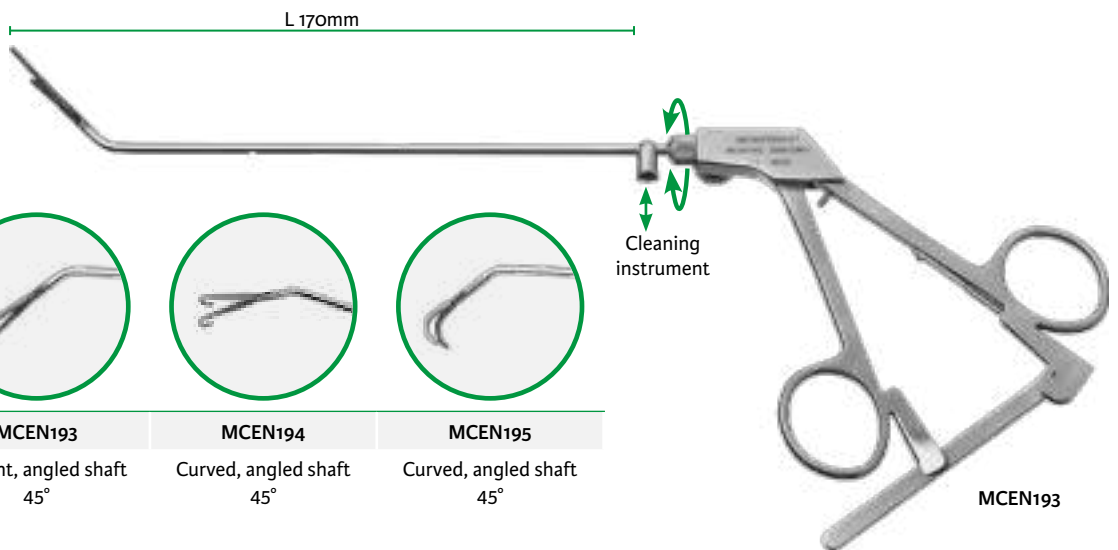

MCEN193

Scale 1/2

Working length "L"

Suction tube with finger control

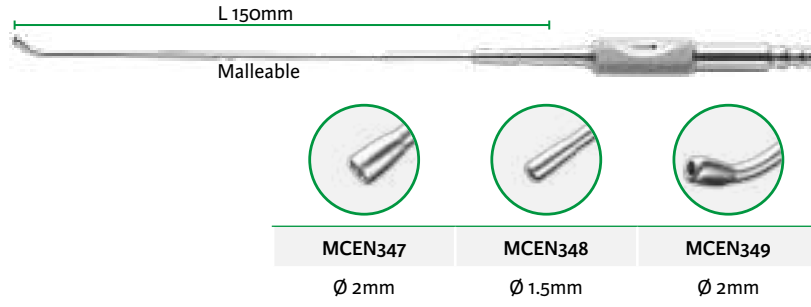

210mm
MCEN349

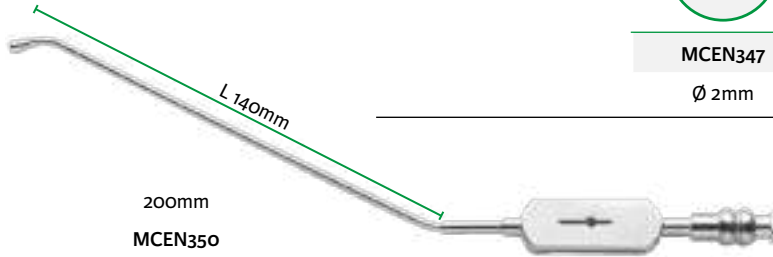

Suction tube , angulated



Hook, Ball probe, Elevator

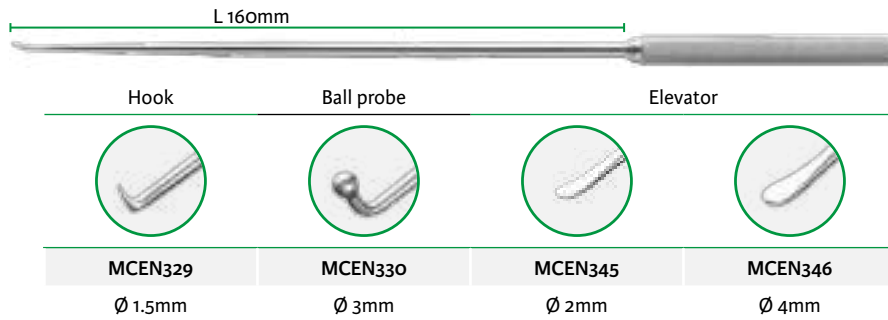

230mm
MCEN345

Cup forceps, scissors, bipolar forceps with stylet handle

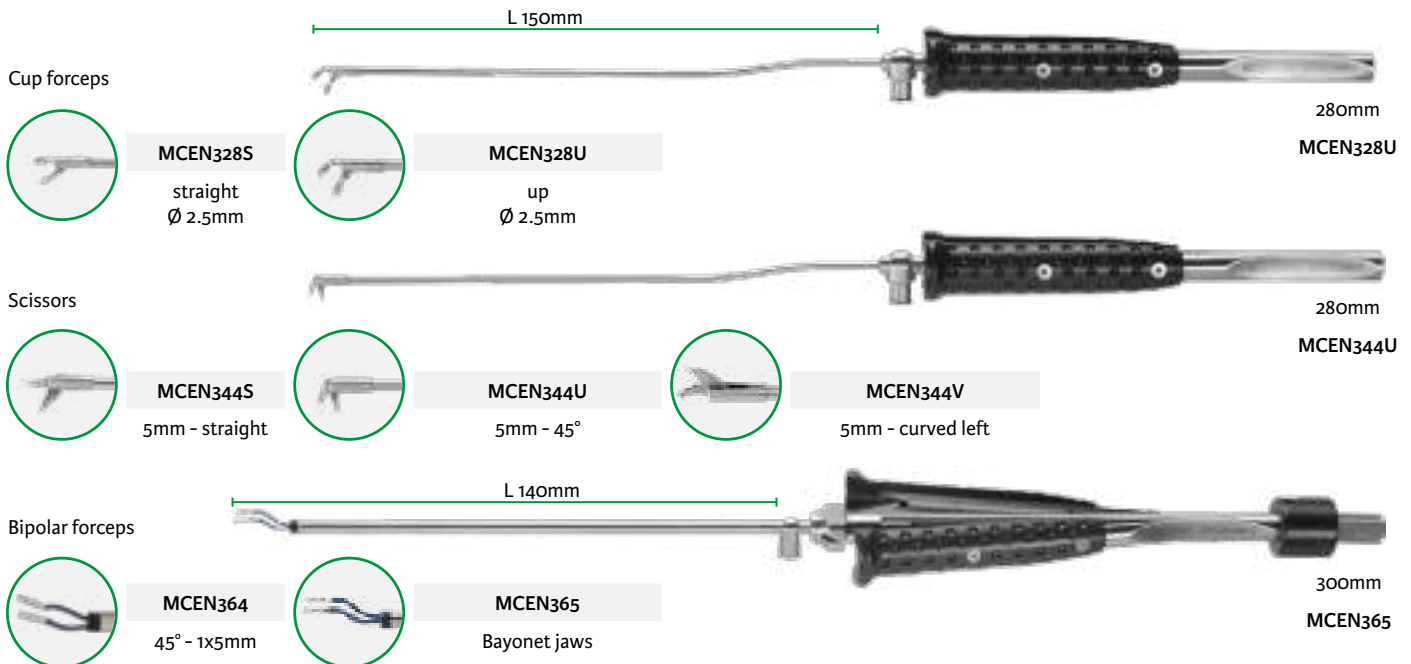

Bipolar cables - 4.5 m

<p>CP393-2 Bowa Emc Lamidey Valleylab</p>	<p>CP393-3 Erbe VIO ICC ACC (except international) Storz Wolf</p>	<p>CP393-4 Aesculap Berchtold Martin Sutter BM-780 II</p>
--	--	--



Scale 1/2

Stainless steel cup

7876-60^{(D)*}	60mm
7876-80^{(D)*}	80mm
7876-100^{(D)*}	100mm
7876-120^{(D)*}	120mm
7876-160^{(D)*}	160mm



Stainless steel tray

7872-24^{(D)*}	240x180mm
-------------------------------	-----------

Scale 1/4

Stainless steel sterilization case

Scale 1/5



7874MF-22

240x105x45mm
220x100x40mm



7874MF-25

270x155x65mm
250x150x60mm

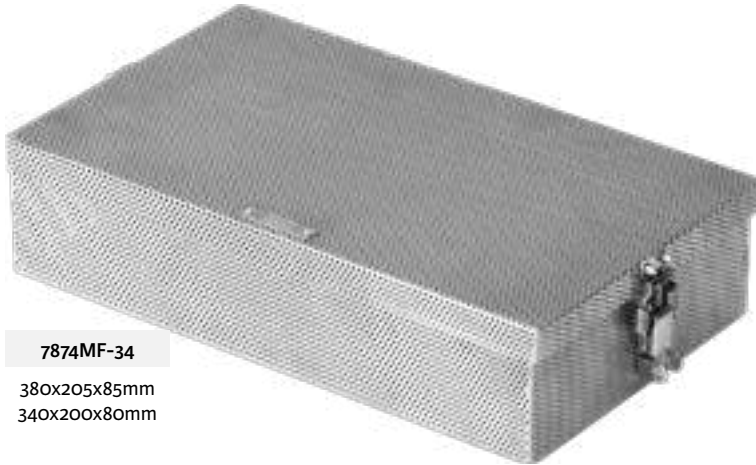

7874MF-34

380x205x85mm
340x200x80mm

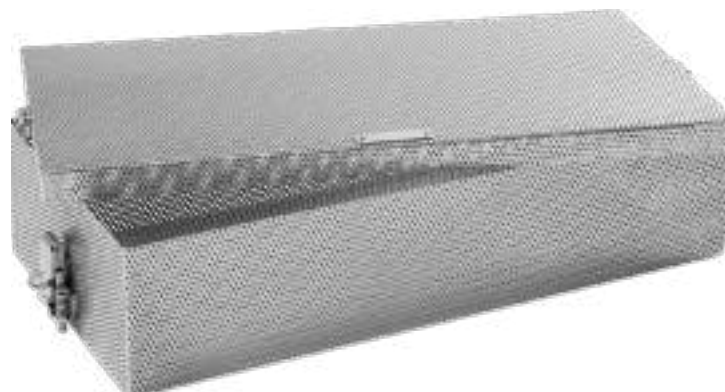

7874MF-40

440x205x95mm - 400x200x90mm

^(D)Distributed by Integra MicroFrance SAS (France) - For corresponding manufacturer part numbers, see table in annex
*Please check with your sales representative availability of this product in your country

Scale 1/3



MCEN136SC

290x175x55mm
270x160x35mm



Toriumi

3717011

528x250x123mm



Numerical index

1

1003IG ^(D)	14
1003LI ^(D)	14
1004IG ^(D)	14
1005I ^(D)	14
1352431.....	77
1375012.....	73
1375020.....	73
1375025.....	73
1375101.....	73
1375102.....	73
1375103.....	73
1375107.....	73
1375110.....	73
1375114.....	73
1375201.....	73
1375207.....	73
1375210.....	73
1375214.....	73

3

3714024.....	19
3714025.....	19
3714026.....	19
3714027.....	20
3714028.....	20
3714055.....	28
3714056.....	28
3714057.....	28
3714058.....	28
3714096.....	33
3714098.....	30
3714099.....	30
3714107.....	19
3714108.....	19
3714109.....	19
3714111.....	19
3714148.....	37
3714149.....	37
3714164.....	15
3714166.....	15
3714182.....	22
3714183.....	22
3714187.....	22
3714320.....	28
3714364.....	19
3714379.....	76
3714678.....	15
3717011.....	107
3724059.....	16
3724256.....	19

7

7706MF.....	2
7717C.....	2
7719-2.....	3
7722-3.....	2
7726MF.....	7
7727.....	7
7728.....	7
7731.....	3
7732-1.....	7
7733.....	7
7734.....	7
7742-1.....	2
7742-2.....	2
7742-3.....	2
7746A ^(D)	2
7746B ^(D)	2
7749.....	8
7750.....	8
7761-1.....	8
7761-2.....	8
7761B-1.....	8
7761B-2.....	8
7761BC1.....	8
7761BC2.....	8
7761BC3.....	8
7761C1.....	8
7761C2.....	8
7761C3.....	8
7762-1.....	83
7762-2.....	83
7762-5.....	79
7762A-1.....	83
7762A-2.....	83
7762A4.....	81
7762A-5.....	79
7762B-1.....	83
7763.....	84
7763-1.....	84
7764.....	40
7765.....	44
7766.....	26
7768.....	18
7768-1.....	18
7771.....	75
7771B.....	75
7774.....	24
7777.....	97
7778.....	97
7778-1.....	97
7778K.....	97
7778K1.....	97

7779MF-1.....	9
7779MF-2.....	9
7779MF-3.....	9
7779MF-5CC.....	9
7782-1-2.....	20
7787-10.....	16
7831A-12.....	55
7831A-15.....	57
7831A-18.....	59
7831A-20.....	61
7832.....	61
7833A-12.....	55
7833A-15.....	57
7833A-18.....	60
7833A-20.....	61
7834.....	61
7866-13.....	68
7867-1.....	65
7867-2.....	65
7867-3.....	65
7867-4.....	65
7872-24 ^(D)	106
7874MF-22.....	106
7874MF-25.....	106
7874MF-34.....	106
7874MF-40.....	106
7876-60 ^(D)	106
7876-80 ^(D)	106
7876-100 ^(D)	106
7876-120 ^(D)	106
7876-160 ^(D)	106
7882.....	2
7896-1.....	2
7896-2.....	2
7896-3.....	2
7897.....	4
7898.....	4
7899.....	4

A

AQ1728 ^(D)	38
-----------------------------	----

CEV

CEV669BG.....	94
CEV984.....	6
CEV985.....	6

^(D) Distributed by Integra MicroFrance SAS (France) - For corresponding manufacturer part numbers, see table in annex

CP

CP16.....	45	CP305.....	30	CP352-3.....	52
CP16-1.....	45	CP305L.....	30	CP353.....	45
CP17.....	18	CP305R.....	30	CP354.....	46
CP17-1.....	18	CP306.....	22	CP354A.....	46
CP17-2.....	18	CP309-8-12.....	31	CP355.....	47
CP17-3.....	18	CP309-10-14.....	31	CP355A.....	47
CP21-3.....	20	CP309-12-16.....	31	CP355C.....	50
CP21A-3.....	20	CP309-14-16.....	31	CP356.....	45
CP23-4.....	22	CP309-14-18.....	31	CP358.....	45
CP23-6.....	22	CP310.....	17	CP358A.....	45
CP23-8.....	22	CP310D.....	17	CP359.....	53
CP23-10.....	22	CP310E.....	17	CP360.....	54
CP23A-8.....	22	CP313.....	32	CP362.....	46
CP37.....	55	CP313-1.....	32	CP363.....	48
CP291.....	35	CP314-14.....	31	CP365.....	50
CP300.....	27	CP315.....	30	CP367.....	47
CP301-1.....	34	CP315D.....	30	CP367-1.....	47
CP301-2.....	35	CP315G.....	30	CP380.....	41
CP301-3.....	35	CP316.....	30	CP380-1.....	41
CP301-4.....	36	CP317.....	29	CP380-2.....	41
CP301-5.....	36	CP318.....	29	CP380-3.....	41
CP301-9.....	36	CP330-3-0.....	69	CP380-5.....	41
CP301-10.....	36	CP330-4-0.....	69	CP381.....	43
CP302-2.....	25	CP331.....	21	CP390-1.....	63
CP302-3.....	25	CP331-1.....	21	CP390-2.....	63
CP302-4.....	25	CP332.....	55	CP390-8.....	63
CP302-5.....	25	CP333.....	15	CP391E.....	63, 96
CP302-6.....	25	CP335.....	20	CP391M.....	63, 96
CP302-8.....	25	CP337.....	13	CP391V.....	63, 96
CP304-2.....	29	CP337-1.....	13	CP392-1R.....	62
CP304-3.....	29	CP338.....	21	CP392-2R.....	62
CP304-4.....	29	CP339.....	21	CP392-8R.....	62
CP304-5.....	29	CP340.....	21	CP392BI.....	62
CP304-6.....	29	CP341.....	21	CP392BS.....	62
CP304-7.....	29	CP344A.....	17	CP393-2.....	62, 94, 95, 105
CP304-8.....	29	CP344AT.....	17	CP393-3.....	62, 94, 95, 105
CP304-9.....	29	CP344B.....	17	CP393-4.....	62, 94, 95, 105
CP304-10.....	29	CP344BT.....	17	CP400.....	57
CP304-11.....	29	CP344C.....	17	CP400-1.....	55
CP304-12.....	29	CP344CT.....	17	CP400-2.....	60
CP304-14.....	29	CP344D.....	17	CP401.....	58
CP304-15.....	29	CP344DT.....	17	CP406.....	55
CP304-16.....	29	CP344E.....	17	CP407.....	57
CP304B-2.....	29	CP344ET.....	17	CP409.....	59
CP304B-3.....	29	CP345.....	58	CP414.....	55
CP304B-4.....	29	CP348.....	53	CP415.....	57
CP304B-5.....	29	CP350.....	54	CP604.....	56
CP304B-6.....	29	CP351-2.....	51	CP604-15.....	56
CP304B-8.....	29	CP351-3.....	51	CP604BR.....	62
CP304B-10.....	29	CP351-6.....	51	CP604M.....	63
CP304B-12.....	29	CP351-7.....	51	CP605.....	56
		CP352.....	52	CP605-15.....	56
		CP352-1.....	52	CP605BR.....	62
		CP352-2.....	52	CP605M.....	63

^(D) Distributed by Integra MicroFrance SAS (France) - For corresponding manufacturer part numbers, see table in annex

MCEN62A2	81	MCEN90	79	MCEN153	100
MCEN62A2DG	80	MCEN90DG	80	MCEN154	100
MCEN62A3	81	MCEN91	79	MCEN155	100
MCEN62B1	81	MCEN91B	79	MCEN156	100
MCEN62B1DG	80	MCEN91BDG	80	MCEN157	100
MCEN62B2	81	MCEN91DG	80	MCEN158	100
MCEN62B2DG	80	MCEN96	85	MCEN161	101
MCEN62B3	81	MCEN97	85	MCEN162	101
MCEN62T1	81	MCEN98	91	MCEN163	101
MCEN62T1DG	80	MCEN99	85	MCEN164	101
MCEN62T2	81	MCEN100-2-0	96	MCEN165	101
MCEN62T2DG	80	MCEN100-2-5	96	MCEN167	101
MCEN62T3	81	MCEN100-3-0	96	MCEN168	101
MCEN64	95	MCEN100-3-5	96	MCEN169	101
MCEN65	90	MCEN101	96	MCEN170	101
MCEN66	90	MCEN102	96	MCEN171	101
MCEN67	90	MCEN103	78	MCEN183	72
MCEN67-1	90	MCEN103LDG	71	MCEN184	72
MCEN67-2	90	MCEN104	24	MCEN186	72
MCEN68	86	MCEN105	96	MCEN187	12
MCEN68ADG	80	MCEN106	24	MCEN190	104
MCEN68BDG	80	MCEN107	24	MCEN191	104
MCEN68CDG	80	MCEN109	24	MCEN192	104
MCEN77-3-0	72	MCEN111	98	MCEN193	104
MCEN77-3-5	72	MCEN112	98	MCEN194	104
MCEN78J30	72	MCEN114	98	MCEN195	104
MCEN78J40	72	MCEN115-6	98	MCEN211	93
MCEN79J25	72	MCEN115-8	98	MCEN211S	93
MCEN79J30	72	MCEN115-9	98	MCEN212	93
MCEN79J40	72	MCEN116	98	MCEN212S	93
MCEN81-C	74	MCEN117	98	MCEN213	93
MCEN81O	74	MCEN118	98	MCEN213S	93
MCEN81O1	74	MCEN120	98	MCEN214	103
MCEN81O2	74	MCEN127	78	MCEN215	103
MCEN81-S	74	MCEN128	96	MCEN216L	103
MCEN81-W	74	MCEN130	102	MCEN216R	103
MCEN82-C	74	MCEN131	102	MCEN217L	103
MCEN82O	74	MCEN133	102	MCEN217R	103
MCEN82O5	74	MCEN134	102	MCEN217S	103
MCEN82O6	74	MCEN135	102	MCEN217U	103
MCEN82-S	74	MCEN136SC	107	MCEN218	104
MCEN82-W	74	MCEN138	103	MCEN328S	105
MCEN83-C	74	MCEN138S	103	MCEN328U	105
MCEN83O	74	MCEN139	103	MCEN329	105
MCEN83OL	74	MCEN139A	103	MCEN330	105
MCEN83-S	74	MCEN140	103	MCEN344S	105
MCEN83-W	74	MCEN140A	103	MCEN344U	105
MCEN84S(D)	74	MCEN141	103	MCEN344V	105
MCEN87C	74	MCEN141A	103	MCEN345	105
MCEN87O3	74	MCEN142	103	MCEN346	105
MCEN87O4	74	MCEN147	103	MCEN347	105
MCEN87-S	74	MCEN149W	102, 103	MCEN348	105
MCEN87W	74	MCEN151	100	MCEN349	105
MCEN88SC	74	MCEN152	100		

MCEN350.....	105
MCEN350H.....	81
MCEN350V.....	81
MCEN351.....	105
MCEN360H.....	81
MCEN360V.....	81
MCEN364.....	105
MCEN365.....	105
MCEN371D4.....	71
MCEN371D35.....	71
MCEN640.....	95
MCEN641.....	95
MCEN643.....	95
MCEN713.....	77
MCEN720.....	99
MCEN721.....	99
MCEN723.....	99
MCEN728DG.....	80
MCEN730.....	96
MCEN760.....	99
MCEN761.....	99
MCEN762.....	99
MCEN763.....	99
MCEN764.....	12
MCEN765.....	12
MCEN766.....	72
MCEN767.....	72
MCEN768.....	99
MCEN769.....	99
MCEN770B25.....	71
MCEN770B30.....	71
MCEN770J30.....	69
MCEN770J40.....	69
MCEN960H.....	81

MCL

MCL38N.....	5
MCL170(D)(1).....	5
MCL171(D)(1).....	5
MCL173(D)(1).....	5
MCL174(D)(1).....	5
MCL197(D)(1).....	5

MCLW

MCLW10.....	103
MCLW11.....	103

MCO

MCO1B.....	70
MCO201-2-5.....	69
MCO201-3-0.....	69
MCO214-13-10.....	28
MCO214-13-20.....	28
MCO214-13-40.....	28
MCO214-13-60.....	28
MCO214-13-80.....	28
MCO233.....	4
MCO237.....	4
MCO305.....	10
MCO311-1-0.....	70
MCO311-1-2.....	70
MCO311-1-5.....	70
MCO311-1-8.....	70
MCO311-2-0.....	70
MCO311-2-5.....	70
MCO311-3-0.....	70
MCO311-3-5.....	70
MCO311-4-0.....	70
MCO770-1-5.....	69
MCO770-2-0.....	69
MCO770-2-5.....	69
MCO770-3-0.....	69
MCO770-3-5.....	69
MCO770-4-0.....	69
MCO771-2-5.....	69
MCO771-3-0.....	69
MCO771-4-0.....	69
MCO772.....	70
MCO775-1.....	70
MCO776.....	70
MCO803.....	10
MCO805.....	3
MCO805A.....	3
MCO807.....	3
MCO950.....	3
MCO978.....	6
MCO978S.....	6
MCO979.....	16
MCO980.....	6
MCO981.....	6
MCO981D.....	6
MCO983-4.....	6
MCO988.....	16
MCO995.....	26

MCSK

MCSK1.....	97
MCSK2.....	97
MCSK3.....	97
MCSK4.....	97
MCSK5.....	97
MCSK6.....	97

P

P761-7.....	65
P761-8.....	65
P762-2.....	66
P762-4.....	66
P763.....	67
P764-1.....	66
P764-3.....	66
P764-5.....	66
P764-7.....	66
P764-11.....	66
P765-14.....	67
P765-16.....	67
P769.....	67

S

SCP337A.....	13
--------------	----

^(D) Distributed by Integra MicroFrance SAS (France) - For corresponding manufacturer part numbers, see table in annex





**Table for corresponding
manufacturer part numbers
For information purposes only**

Integra MicroFrance® product reference	Corresponding manufacturer part number
1003IG	M3IG
1003LI	M3LI
1004IG	M4IG
1005I	M5I
7746A	651
7746B	650
7872-24	1224
7876-100	310
7876-120	312
7876-160	316
7876-60	306
7876-80	308
AQ1728	PS-1728
MCEN84S	MCEN84S
MCL38N	EC-BLU50U090
MCL170 ⁽¹⁾	CO101
MCL171 ⁽¹⁾	CO201
MCL173 ⁽¹⁾	CO100
MCL174 ⁽¹⁾	CO200
MCL197 ⁽¹⁾	CO103

⁽¹⁾ Not a medical device



Integra MicroFrance SAS (France)
Le Pavillon ■ 03160 Saint Aubin le Monial ■ France

CE Class I products only:



HEMODIA SAS
85, rue du Chêne Vert
31670 LABEGE ■ France



Concorde Import Export
B.P. 37
92300 Levallois-Perret ■ France



Agencinox
Zone Industrielle
89110 Aillant sur Tholon ■ France



Qfix
440 Church Road
Avondale ■ PA 19311 USA



Advena Limited
Tower Business Center ■ 2nd Floor
Tower Street ■ Swatar ■ BKR 4013 Malta



Sunoptic Technologies®, LLC
6018 Bowdendale Avenue
Jacksonville ■ FL 32216 USA



AJW Technology Consulting GmbH
Breite Straße 3
40213 ■ Düsseldorf ■ Germany



Swann Morton Ltd
Penn Works ■ Owlerton Green ■ Sheffield
South Yorkshire S6 2BJ ■ United Kingdom



Emergo Europe
Prinsessegracht 20
2514 AP ■ The Hague ■ The Netherlands

Availability of these products might vary from a given country or region to another, as a result of specific local regulatory approval or clearance requirements for sale in such country or region.

- Consult product labels and inserts for any indications, contraindications, hazards, warnings, precautions, and instructions for use.
- Non contractual document. The manufacturer reserves the right, without prior notice, to modify the products in order to improve their quality.
- Warning: Applicable laws restrict these products to sale by or on the order of a physician.

Additional information for EMEA Customers only :

Products mentioned in this document are CE class I, Im, IIa or IIb devices. Contact Integra should you need any additional information on devices classification.
All the medical devices mentioned on this document are CE marked in accordance with the applicable European laws, unless specifically identified as "NOT CE MARKED".
Products marked with the symbol^(®) are distributed by Integra MicroFrance SAS (France).

Date of last révision : 04/2023

For more information, please contact customer service :

Europe, Middle-East, Africa

International: +33 (0) 437 47 59 50 ■ +33 (0) 437 47 59 25 (Fax) ■ csemea@integralife.com
France: +33 (0) 437 47 59 10 ■ +33 (0) 437 47 59 29 (Fax) ■ custservfrance@integralife.com
United Kingdom: +44 (0) 1264 312 725 ■ +44 (0) 1264 312 821 (Fax) ■ custsvcs.uk@integralife.com
Belgium & Luxembourg: +32 (0)2 257 4130 ■ +32 (0)2 253 2466 (Fax) ■ custsvcbenelux@integralife.com
Netherlands: +31(0) 852 083 167 ■ +31(0) 207 093 627 (Fax) ■ custsvcnetherlands@integralife.com
Italy: +39 (0)2 577 8921 ■ +39 (0)2 575 113 71 (Fax) ■ custsvcitaly@integralife.com
integralife.eu/contact

Integra and the Integra logo are registered trademarks of Integra LifeSciences Corporation or its subsidiaries in the United States and/or other countries.

MicroFrance is a trademark of Integra LifeSciences Corporation or its subsidiaries.
All other trademarks and product names are the property of their respective owners.

© 2023 Integra LifeSciences Corporation. All rights reserved.

0332452-5-EN

DOCUMENT FOR USE IN EUROPE, MIDDLE-EAST AND AFRICA ONLY.