



Integra[®] MicroFrance[®]

Catalogue Integra Laparoscopie

Table des matières	ii - iii	Poignée rotative 5 et 10 mm	44
Service Client et Garanties	iv	Poignée axiale	44
Indications / Contre-indications	v	Poignée ergonomique	44
Les instruments démontables - MicroFrance®	vi - vii	Poignée revolver	44
Pince mors fenêtrés - 5 mm	2 - 6	Tube métallique pour poignée rotative 5 et 10 mm	45
Pince mors fenêtrés avec graduation - 5mm	7	Poignée non rotative 5 mm et tube gainé	46
Pince mors fenêtrés - 10 mm	8 - 9	Poignée axiale	46
Pince mors Babcock	10 - 11	Poignée revolver	46
Pince mors striés - 5 mm	12 - 13	Tube gainé pour instrument non rotatif	46
Pince mors à griffes	14 - 16	Poignée non rotative 5 mm et tube métallique	47
Dissecteur - 5 mm	17 - 19	Poignée ergonomique	47
Dissecteur - 10 mm	20 - 21	Tube métallique pour instrument non rotatif	47
Porte-aiguille - 5 mm	22 - 23	Câbles Bipolaires	48
Porte-aiguille - 10 mm	24	Pince bipolaire non rotative 5 mm	49 - 52
Pousse-noeud, Ciseaux pousse-noeud	25	Insert	49, 51
Ciseaux - 5 mm	26 - 28	Instrument complet non démontable	50, 52
Gaine noire	27	Crochet monopolaire	53
Insert	26	Bistouri rétractable, Palpateur monopolaire	54
Insert ciseaux courbes	27	Bistouri rétractable	54
Insert ciseaux isolés	27	Câble monopolaire	54
Insert tige	27	Lame de bistouri	54
Instrument complet non démontable	28	Palpateur monopolaire	54
Tube métallique	27	Ecarteur & Palpateur	55
Ciseaux - 10 mm	29	Ecarteur rétracteur	55
Clamp vasculaire - 5 mm	30	Ecarteur rétracteur articulé	55
Clamp vasculaire - 12 mm	31	Palpateur boutonné	55
Clamp vasculaire - 10 mm	32 - 33	Palpateur spatulé	55
Clamp intestinal	34 - 35	Bras articulé	56
Clamp aortique percutané	36 - 37	Bras articulé flexible	56
Clamp Bull-dog, Pince pose-clamps	38	Cavalier	56
Pince à clips, Pince pour enclume	39	Porte-instrument	56
Poignée revolver rotative - 5 et 3,5mm	40	Laveur aspirateur électrique	57
Poignée axiale rotative - 5 et 3,5mm	41	Aspirateur irrigateur pour poignée	57
Poignée ergonomique rotative - 5 et 3,5mm	42	Chemise lavante pour optique	57
Tube 5 mm pour poignée rotative 5 et 3,5 mm	43	Tubulure stérile pour laveur électrique	57
Tube gainé	43	Laveur aspirateur	58
Tube non gainé et boîte de 3 gaines	43	Aspirateur irrigateur démontable	58
		Aspirateur irrigateur standard	58
		Poignée pour aspirateur démontable	58
		Aiguille & Passe-fil	59
		Cholangiographie & Cholédoscopie	60

Trocart modulaire - 3,5 mm	61 - 62	Instrumentation pédiatrique 3,5 mm	76 - 81
Trocart composite à valve silicone	62	Aspirateur irrigateur	77
Trocart métal à valve aimantée	61	Bistouri à lame rétractable	77
Trocart métal à valve silicone	61	Ciseaux	80
Trocart modulaire - 5,5 mm	63	Crochet monopolaire	77
Corps de trocart composite à valve silicone	63	Insert mors avec tube gainé	79
Trocart composite à valve aimantée	63	Instrumentation de De Lagausie	81
Trocart composite à valve silicone	63	Pince	80
Trocart modulaire - 10,5 mm	64	Pince bipolaire	78
Mandrin de trocart palpateur	64	Porte-aiguille	81
Trocart composite à valve aimantée	64	Raccord pour lavage insert tube	79
Trocart composite à valve silicone	64	Trocart composite à valve silicone	76
Trocart modulaire - 12/13 mm	65	Instrumentation mini invasive 5mm poignée stylet	82
Trocart composite à valve aimantée	65	Ciseaux courbes mors titane	82
Trocart composite à valve silicone	65	Pince mors à griffes	82
Trocart à piston	66	Porte-aiguille mors titane	82
Ressort pour trocart à piston	66	Porte-aiguille mors tungstène	82
Trocart à piston	66	Set d'Henry - 3,0mm	83
Trocart à clapet automatique	67	Bague de fixation	83
Accessoires pour trocart	68	Ciseaux	83
Ecarteur double «open laparo»	68	Crochet monopolaire	83
Joint pour trocart	68	Palpateur	83
Réducteur trocart	68	Pince mors fenêtrés	83
Instrumentation thoracique	69	Pince mors striés alligator	83
Insert mors curette	69	Trocart	83
Pince mors curette	69	Set de Terris	84
Pince mors fenêtrés	69	Aspirateur à soupape et crépine	84
Trocart	69	Décolleur aspirateur malléable	84
Pince bipolaire avec irrigation	70	Décolleur courbe	84
Instrumentation mini port 3,5 mm	71 - 75	Ecarteur double	84
Aspirateur irrigateur	74	Porte-boule de coton	84
Crochet monopolaire	74	Pince à biopsie rectale de Scheye	85
Insert	71	Insert et tube pour biopsie	85
Instrument complet non démontable	72	Poignée axiale	85
Palpateur	74	Panier & plateaux, divers accessoires	86
Pince bipolaire	73	Capuchon	86
Pince sans trocart	74	Panier Inox	86
Pousse-noeud	74	Panier plastique	86
Raccord pour lavage insert tube	71	Plateau inox	86
Trocart métal à valve aimantée	75	INDEX numérique	87
Trocart métal à valve silicone	75	Tableau d'équivalence Distribué par Integra MicroFrance SAS (France)	92

Garantie limitée d'Integra

Pour connaître les garanties applicables, merci de vous référer aux garanties précisées dans l'emballage de chaque produit.

Contacts Services Clients :

International

+33 (0) 4 37 47 59 50
+33 (0) 4 37 47 59 25 (fax)
csemea@integralife.com

France

+33 (0) 4 37 47 59 10
+33 (0) 4 37 47 59 29 (Fax)
custservfrance@integralife.com

Belgique & Luxembourg

+32 (0) 2 257 4130
+32 (0) 2 253 2466 (Fax)
custsvcbenlux@integralife.com

Royaume-Uni

+44 (0) 1264 312 725
+44 (0) 1264 312 821 (Fax)
custsvcs.uk@integralife.com

Pays-Bas

+31 (0) 852 083 167
+31 (0) 207 093 627 (Fax)
custsvcnetherlands@integralife.com

Italie

+39 (0) 2 577 8921
+39 (0) 2 575 113 71 (Fax)
custsvitaly@integralife.com

Instrumentation Laparoscopie MicroFrance®

INDICATIONS

- Tous les dispositifs médicaux présentés dans ce catalogue sont indiqués pour le diagnostic et/ou la chirurgie Laparoscopique.
- Les dimensions présentes dans ce document ne sont pas contractuelles et sont données à titre indicatif seulement.

CONTRE-INDICATIONS

- Ne pas utiliser dans d'autres indications que celles prévues (mentionnées) dans la notice d'instruction ou l'étiquetage.

Explications sur la présentation de ce catalogue

Titre et/ou famille produit

Symbole "Instrument complet"

Symbole "démontable"

Représentation du mors de l'instrument à l'échelle 1/1 sauf indications contraires

Démontable				
Mors, Échelle 1/1	Longueur utile			N° Pages
	Court	Standard	Long	
Johann 200gmm	CEV8625CU 345 mm	CEV8625CU 345 mm	CEV8625CU 445 mm	Rotatif 40 -> 47 Non rotatif 48 - 49
Canaze 200gmm	-	CEV8625CU 345 mm	-	
Canaze 200gmm	Bertrand CEV8625CU 345 mm	Bertrand CEV8625CU 345 mm	Bertrand CEV8625CU 445 mm	
Johann 200gmm	-	CEV8625CU 345 mm Design Suisse	-	
à mors mobile 200gmm	CEV8625DU 345 mm	CEV8625DU 345 mm	CEV8625DU 445 mm	

NON démontable Instruments complets			
Mors, Échelle 1/1	Poignée	Longueur utile	
		Court	Standard
Johann 200gmm	A cormalline	-	Johann CEV8625U 345 mm
Johann 200gmm	A assort	-	Cajet CEV8625C 345 mm
Johann 200gmm	A cormalline	-	Montupet CEV8625U 240 mm
Johann 200gmm	A cormalline	-	CEV8625U 240 mm
Johann 200gmm	A cormalline longue	-	CEV8625U 345 mm
Canaze 200gmm	A cormalline	-	CEV8625U 345 mm
Canaze 200gmm	A cormalline	-	Bertrand CEV8625C 345 mm

DOCUMENT DESTINE A L'EUROPE, AU MOYEN-ORIENT ET A L'AFRIQUE.

Sauf indications contraires, les pages de ce catalogue se présentent ainsi :

- Page de gauche : Instruments démontables
- Page de droite : Instruments complets non démontables

Dans la majorité des cas, les instruments démontables sont mis en correspondance avec les instruments complets. Si il n'y a aucune correspondance, il est affiché un “_” sur la ligne correspondante. Exemple : L'insert CEV8625CU n'existe pas en instrument complet.

Dans le tableau des inserts démontables, un renvoi aux pages des “poignées” à utiliser avec les inserts est indiqué. Sur cette dernière, les tubes compatibles avec les poignées sont affichés à côté de la page des poignées.

Voir la composition des instruments démontables en page suivante.

Les instruments démontables laparoscopiques MicroFrance® se décomposent en trois parties : Mors, Gaine Tube et Poignée.
La portion noire de l'étiquette indique la section présentée dans la page en cours :

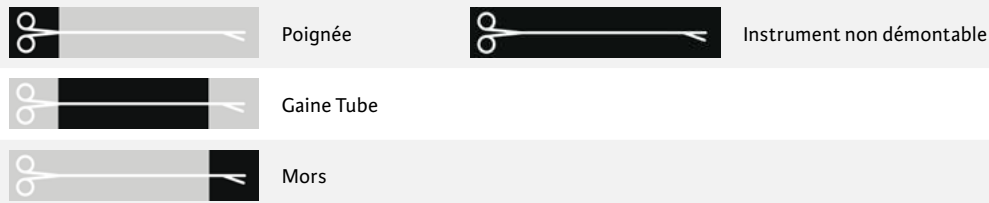

Dans la majorité des cas, les instruments démontables sont mis en correspondance avec les instruments complets non démontables.

Poignées

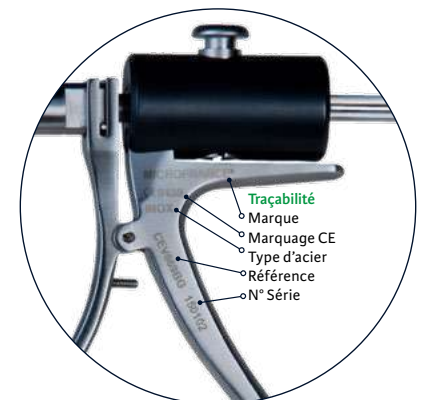
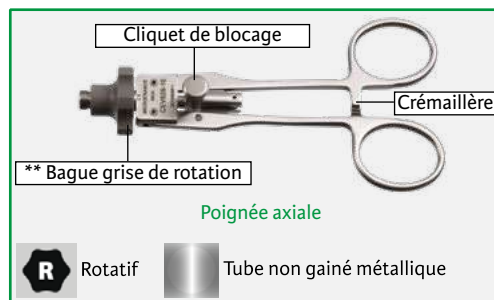
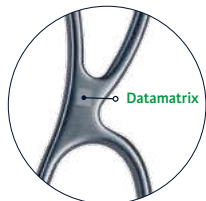
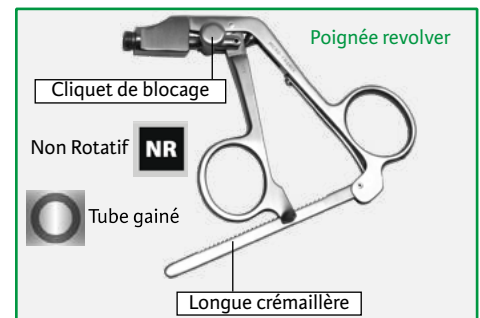
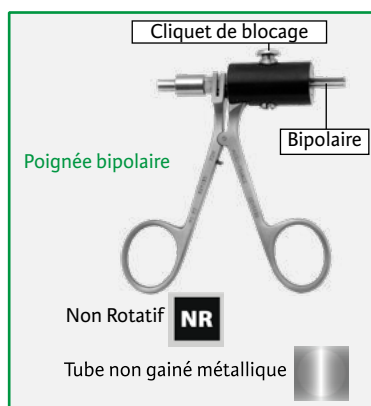
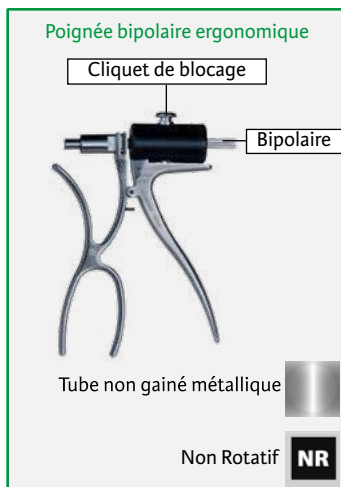
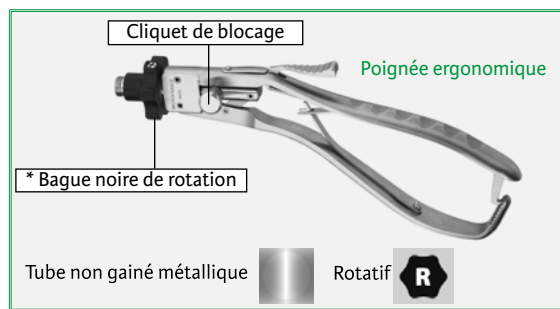

** Bague grise de rotation pour tube métallique ou tube non gainé Ø5 et 10mm

* Bague noire de rotation pour tube gainé Ø5mm

Mors

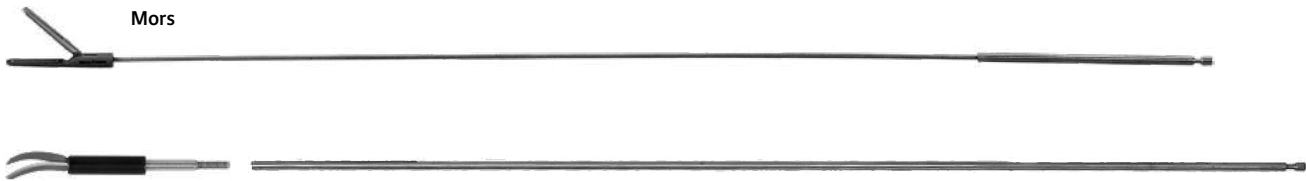





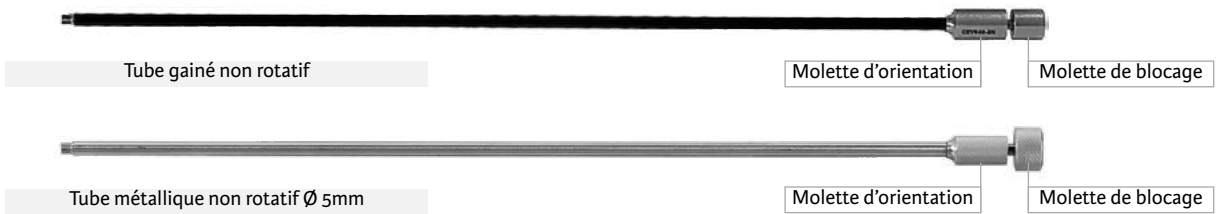

Insert mors ciseaux démontables : Insert Mors ciseaux et Insert Tige

Gaines Tubes

Instrument non rotatif	Instrument rotatif	Tube gainé	Tube métal non gainé	Tube avec Gaine indépendante	Utilisé pour Instrument Bipolaire
NR	R				

















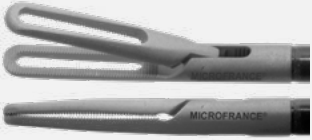

Démontable				
Inserts			Poignée	
Mors Echelle 1/1	Longueur utile			N° Pages
	Court	Standard	Long	
 Johann 20x5mm	CEV8625T1U 245 mm	CEV625T1U 345 mm	CEV9625T1U 445 mm	 Rotatif 40 -> 45
 Concave 20x5mm	-	CEV670T1U 345 mm	-	Non rotatif 46 -> 47
 Courbe 20x5mm	Bertrand CEV8625CU 245 mm	Bertrand CEV625CU 345 mm	Bertrand CEV9625CU 445 mm	
 Johann 20x5mm	-	CEV625P1U 345 mm Design Suisse	-	
 2 mors mobiles 20x5mm	CEV8625DU 245 mm	CEV625DU 345 mm	CEV9625DU 445 mm	



NON démontable

Instruments complets

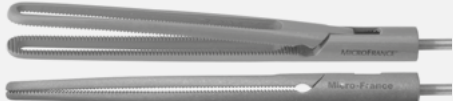







Mors Echelle 1/1	Poignée	Longueur utile	
		Court	Standard
 Johann 20x5mm	 A crémaillère	-	Johann CEV405U 365 mm
	 A ressort	-	Gayet CEV405BG 365 mm
	 A crémaillère	Montupet CEV815 240 mm	-
	 A crémaillère	CEV915G 240 mm	CEV525 345 mm
	 A crémaillère longue	-	CEV725 345 mm
 Concave 20x5mm	 A crémaillère	-	CEV470U 365 mm
 Courbe 20x5mm	 A crémaillère	-	Bertrand CEV525C 345 mm







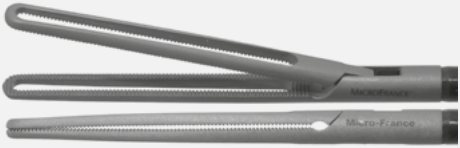

	Démontable				
	Inserts			Poignée	
	Mors Echelle 1/1	Longueur utile			
	Court	Standard	Long		
 15x5mm	-	CEV4o6IU 340 mm	-		
 Desmaizieres 20x3mm	CEV84o7IU 245 mm	CEV4o7IU 345 mm	CEV94o7IU 445mm		
 40x5mm	CEV866oT1U 270 mm	CEV66oT1U 370 mm	CEV966oT1U 470 mm		
 Concave 40x5mm	-	CEV671T1U 370 mm	-	Rotatif 40 -> 45	
 Crovella 40x5mm mors lisses	-	CEV661IU 370 mm	-	Non rotatif 46 -> 47	
 Crovella 30x5mm mors lisses	-	CEV662IU 335 mm	-		



NON démontable





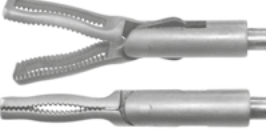

Instruments complets







Mors Echelle 1/1	Poignée	Longueur utile	
		Standard	
 15x5mm		A crémaillère	CEV406U 360mm
 Desmaizieres 20x3mm		A crémaillère	Desmaizieres CEV407U 365mm
 40x5mm		A crémaillère	Desplantez CEV460U 385mm
		Axiale à crémaillère longue	CEV760 365mm
 Concave 40x5mm		A crémaillère	CEV470T1U 385mm

	Démontable				
	Inserts			Poignée	
	Mors Echelle 1/1	Longueur utile			
	Court	Standard	Long		
 2 mors mobiles ronds 15x5mm	-	CEV433DU 350 mm	-	   Rotatif 40 -> 45 Non rotatif 46 -> 47  	
 Mors dentelés 20x5mm	CEV8625EU 245 mm	CEV625EU 345 mm	-		
 Porpiglia 1 mors fenêtré 20x5mm	-	CEV625PU 345 mm	-		
 2 mors mobiles concaves 15x5mm	CEV8670DU 240 mm	CEV670DU 340 mm	CEV9670DU 440 mm		

Démontable



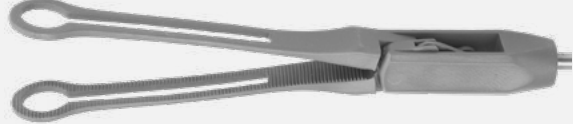









Inserts		Poignée
Mors Echelle 1/1		N° Pages
 <p>De Manzini CEV7625I 435 mm - 20x5mm</p>	 <p>Scopinaro CEV7660I 435 mm - 40x5mm</p>	
Tubes Echelle 1/3		
CEV649M5	CEV649G5	
 <p>Graduation 50 / 100 / 150 mm</p>	 <p>Graduation 100 / 150 / 200 mm</p>	 <p>Rotatif 44 - 45</p> 







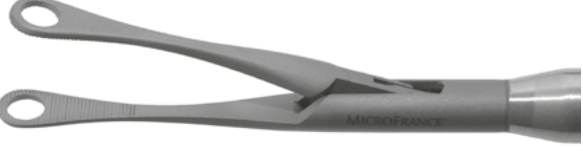

	Démontable		
	Inserts		Poignée
	Mors Echelle 1/1	Longueur utile	N° Pages
	 Mors ronds, 2 mors mobiles	CEV433-1 370 mm	 Rotatif 44 - 45 
	 35x10mm	CEV610-1 375 mm	
	 Hüscher Mors ronds, 2 mors mobiles	CEV433H 380 mm	
	 Mors ronds, 2 mors mobiles avec tube CEV864910B (page 45)	CEV8434I 295 mm Court	



NON démontable

Instruments complets







Mors Echelle 1/1	Poignée	Longueur utile
 Mors ronds, 2 mors mobiles	 Axiale à crémaillère	CEV533-2 370 mm
 35x10mm	 Revolver, crémaillère longue	CEV410 360 mm
	 Axiale à crémaillère	CEV530 370 mm
 Duval	 Revolver, crémaillère longue	CEV432 365 mm
	 Axiale à crémaillère	CEV507 375 mm
 Mors ronds	 Revolver, crémaillère longue	CEV433 365 mm











Démontable		
Inserts		Poignée
Mors Echelle 1/1	Longueur utile	N° Pages
 Ø10mm	Delaitre CEV602-1 370 mm	 Rotatif 44 - 45 
 Delaitre Ø5mm	Court Standard	   Rotatif 40 -> 45 Non rotatif 46 -> 47  
	CEV8621T1U 250 mm CEV621T1U 350 mm	



NON démontable

Instruments complets









Mors Echelle 1/1	Poignée	Longueur utile				
 Ø10mm	 Revolver, crémaillère longue	Delaitre CEV420 360 mm				
	 Axiale avec crémaillère	Delaitre CEV502 370 mm				
 Ø5mm	 Revolver, crémaillère longue	<table border="1"> <thead> <tr> <th>Court</th> <th>Standard</th> </tr> </thead> <tbody> <tr> <td> Montupet CEV821G 245 mm </td> <td> Delaitre CEV421 370 mm </td> </tr> </tbody> </table>	Court	Standard	Montupet CEV821G 245 mm	Delaitre CEV421 370 mm
	Court	Standard				
	Montupet CEV821G 245 mm	Delaitre CEV421 370 mm				
 Axiale à crémaillère	– Delaitre CEV521 350 mm					
 Axiale, crémaillère longue	– CEV721 350 mm					











	Démontable			
	Inserts			Poignée
	Mors Echelle 1/1	Longueur utile		
	Court	Standard	Long	
 Manhès 10mm	-	CEV614T1U 335 mm	CEV9614T1U 435 mm	
 Manhès 15mm	CEV8615T1U 240 mm	CEV615T1U 340 mm	CEV9615T1U 440 mm	  
 Manhès 20mm	-	CEV620T1U 345 mm	CEV9620T1U 445 mm	Rotatif 40 -> 45 Non rotatif 46 -> 47
 Dauphin 20x3mm	-	CEV617IU 340 mm	CEV9617IU 440 mm	 
 Mors striés crocodile, 2 mors mobiles 15x5mm	CEV8624IU 240 mm	CEV624IU 340 mm	CEV9624IU 440 mm	



NON démontable

Instruments complets













Mors Echelle 1/1	Poignée	Longueur utile	
		Standard	
 10mm	 A crémaillère	Manhès CM110U 355 mm	
 15mm	 A crémaillère	Manhès CM115U 360 mm	
	 Axiale à crémaillère	CEV515 340 mm	
 20mm	 A ressort	Manhès CEV220U 365 mm	
	 A crémaillère	Manhès CM120U 365 mm	









		Démontable				
		Inserts			Poignée	
Mors Echelle 1/1		Longueur utile			N° Pages	
 Ø10mm Mors à griffes		Museux CEV606-1 370 mm			 Rotatif 44 - 45 	
		Court	Standard	Long		
 Manhès Grip-pince Ø5mm		CEV8611T1U 235 mm	Manhès CEV611T1U 335 mm	CEV9611T1U 435 mm	   Rotatif 40 -> 45	
 Manhès Cobra Ø5mm		-	Manhès CEV612T1U 340 mm	-	Non rotatif 46 -> 47 	
 Manhès Tigre Ø5mm		CEV8613T1U 240 mm	Manhès CEV613T1U 340 mm	-		











NON démontable









Instruments complets

Mors Echelle 1/1	Poignée	Longueur utile
		Standard
 Ø10mm	 Revolver à ressort	Museux CEV321 360 mm
	 Axiale à crémaillère	Museux CEV506 370 mm
 Manhès Grip-pince Ø5mm	 A ressort	CEV211U 355 mm
	 A crémaillère	Manhès CM111U 355 mm
	 Axiale à crémaillère	Manhès CEV511 335 mm
 Manhès Cobra Ø5mm	 A crémaillère	Manhès CM112U 355 mm
	 Axiale à crémaillère	Manhès CEV512 335 mm
 Manhès Tigre Ø5mm	 A crémaillère	Manhès CM113U 360 mm







	Démontable				
	Inserts			Poignée	
	Mors Echelle 1/1	Longueur utile			
	Court	Standard	Long		
 cobra 2 mors mobiles Ø5mm	CEV8612DU 240 mm	CEV612DU 340 mm	CEV9612DU 440 mm	   Rotatif 40 -> 45	
 Vallancien Mors fenêtrés à griffes Ø5mm 20x5mm	CEV8616IU 245 mm	CEV616IU 345 mm	-	Non rotatif 46 -> 47  	







Démontable

Inserts		Poignée
Mors Echelle 1/1	Longueur utile	N° Pages
 <p>Delaitre 2 mors mobiles, 22mm Ø5mm</p>	<p>CEV641DU 355 mm</p>	  <p>Rotatif 40 -> 45</p> <p>Non rotatif 46 -> 47</p>  
 <p>2 mors mobiles, 20mm Ø5mm</p>	<p>CEV641FU 350 mm</p>	
 <p>Allal 2 mors mobiles 15mm Ø5mm</p>	<p>CEV642TFU 345 mm</p>	
 <p>2 mors mobiles coudés à 90° 20mm Ø5mm</p>	<p>CEV643IU 345 mm</p>	

	Démontable				Poignée
	Inserts			N° Pages	
	Mors Echelle 1/1	Longueur utile			
	Court	Standard	Long		
 Courbure courte 2 mors mobiles 12mm	-	CEV532IU 335 mm	-	  Rotatif 40 -> 45 Non rotatif 46 -> 47	
 Courbure moyenne 2 mors mobiles 15mm	CEV8641T1U 245 mm	CEV641T1U 345 mm	CEV9641T1U 445 mm		
 Courbure longue 2 mors mobiles 18mm	CEV8642T1U 245 mm	CEV642T1U 345 mm	CEV9642T1U 445 mm	 	

NON démontable
Instruments complets





	NON démontable		
	Instruments complets		
Mors Echelle 1/1	Poignée	Longueur utile	
 <p>Courbure courte à gauche 2 mors mobiles 12mm</p>	 <p>Axiale à crémaillère</p>	<p>CEV532 340 mm</p>	
 <p>Courbure moyenne à gauche 2 mors mobiles 15mm</p>	 <p>Axiale à crémaillère</p>	<p>CEV531-2 340 mm</p>	
 <p>Courbure longue à gauche 2 mors mobiles 18mm</p>	 <p>Axiale à crémaillère</p>	<p>CEV531T3U 350 mm</p>	





	Démontable		
	Inserts		Poignée
	Mors Echelle 1/1	Longueur utile	N° Pages
 Delaitre Courbure moyenne à gauche 50mm	CEV601-1 380 mm		
 Delaitre Courbure moyenne - 2 mors mobiles 50mm	CEV651-1 380 mm		
 Pignata Courbure courte à gauche 90°, 45mm	CEV601P 380 mm	Rotatif 44 - 45	
 Puglisi Courbure longue 2 mors mobiles 60mm	CEV652l 380 mm		

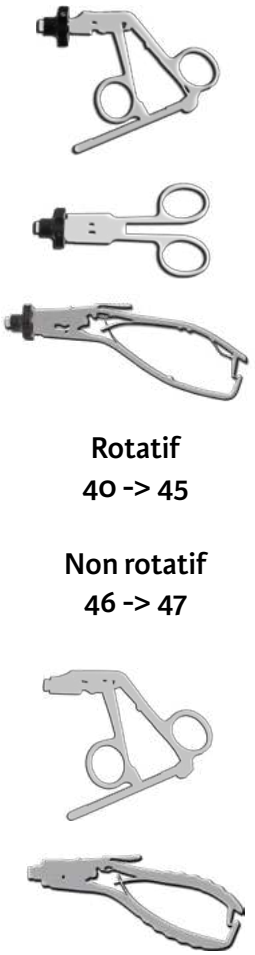

NON démontable

Instruments complets

















Mors Echelle 1/1	Poignée	Longueur utile
 <p>Courbure moyenne à gauche 50mm</p>	 <p>Revolver</p>	<p>Delaitre CEV430 370 mm</p>
	 <p>Axiale à crémaillère</p>	<p>Nouaille CEV501 380 mm</p>
 <p>Delaitre Courbure moyenne à gauche - 2 mors mobiles 50mm</p>	 <p>Axiale à crémaillère</p>	<p>Delaitre CEV501-2 380 mm</p>









	Démontable				
	Inserts			Poignée	
	Mors Echelle 1/1	Longueur utile			
Court		Standard	Long		
 Droit tungstène	—	CEV500TU 335 mm	CEV9500TU 435 mm		
 Courbe à gauche tungstène	CEV8538TU 240 mm	CEV538TU 340 mm	—	Rotatif 40 -> 45 Non rotatif 46 -> 47	
 Courbe à droite tungstène	CEV8544IU 240 mm	CEV544IU 340 mm	CEV9544IU 440 mm		
 Droit automatique titane	CEV8650TU 235 mm	CEV650TU 335 mm	CEV9650TU 435 mm		



NON démontable

Instruments complets

Mors Echelle 1/1	Poignée	Longueur utile		
		Court	Standard	Long
 Droit tungstène	 Axiale à crémaillère	CEV965 230 mm	CEV500T5 335 mm	–
	 Ergonomique grip large gâchette en haut à crémaillère	–	CEV700T5 335 mm	–
	 Ergonomique grip large gâchette en bas à crémaillère	–	CEV700T5D 335 mm	CEV9700T5D 450 mm
 Mors courbes à gauche, tungstène	 Axiale à crémaillère	–	CEV538T5 335 mm	–
	 Ergonomique grip large gâchette en bas à crémaillère	–	CEV738T5 335 mm	CEV9738T5 455 mm
	 Ergonomique grip fin	–	CEV738-5 350 mm	–
	 Ergonomique grip fin	–	CEV738D5 350 mm	–
 Mors courbes à droite, tungstène	 Axiale à crémaillère	–	CEV544 335 mm	–
	 Ergonomique grip large gâchette en bas à crémaillère	–	CEV744T5 335 mm	CEV9744T5 455 mm
 Mors droits automatiques titane	 Axiale à crémaillère	–	Mouiel CEV540-5 335 mm	–
	 Ergonomique grip large gâchette en bas à crémaillère	–	CEV650T5D 335 mm	–
	 Ergonomique grip fin	–	CEV740-5 350 mm	–











NON démontable			
Instruments complets			
Mors Echelle 1/1	Poignée	Longueur utile	
 Nouaille Mors droits	 Axiale à crémaillère	Nouaille CEV500-A10 345 mm	
 Mors courbes à gauche	 Axiale à crémaillère	CEV538-10 345 mm	
 Mors droits automatiques	 Axiale à crémaillère	Mouiel CEV540-10 345 mm	
	 Ergonomique grip fin	CEV640-10 340 mm	

Pousse-noeud - 5 mm







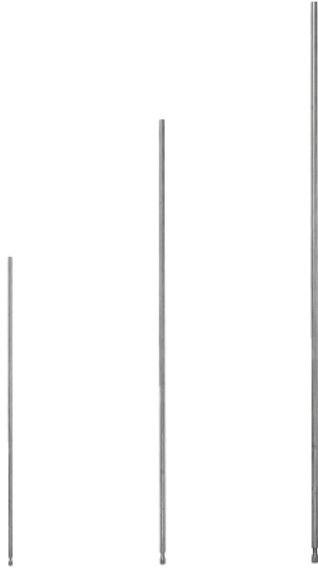

		NON démontable	
		Instruments complets	
	<p>Delaitre CEV442 L 340 mm</p>		<p>Longueur utile «L» Echelle 1/3</p>
	<p>CEV442E L 300 mm</p>		
	<p>CEV442Z L 350 mm</p>		

Ciseaux pousse-noeud - 5 mm





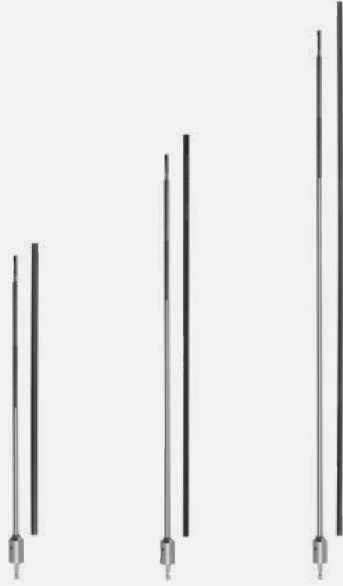



		NON démontable		Longueur utile		
		Instruments complets		Court	Standard	Long
	<p>Mors Echelle 1/1</p>	<p>Poignée</p>				
	<p>Drouard Instrument complet non démontable</p>		<p>Poignée revolver</p>	-	<p>CEV445-5 355 mm</p>	-
	Démontable					
	<p>Drouard Instrument démontable</p>			<p>CEV8445IU 235 mm</p>	<p>CEV445IU 335 mm</p>	<p>CEV9445IU 435 mm</p>
		<p>Rotatif 40 -> 45</p>	<p>Non rotatif 46 - 47</p>			

Démontable				
Inserts				Poignée
Lames Echelle 1/1	Longueur utile			N° Pages
	Court	Standard	Long	
 Droites, 1 mors mobile cranté 10mm	CEV8104IU 240 mm	CEV104IU 340 mm	CEV9104IU 440 mm	
 Droites, 2 mors mobiles 10mm	CEV8623T1U 240 mm	CEV623T1U 340 mm	CEV9623T1U 440 mm	
 Courbes, 2 mors mobiles 15mm	CEV8605T1U 245 mm	CEV605T1U 345 mm Pack 1 CEV605T3U 345 mm Pack 3	CEV9605T1U 445 mm	 
 Courbes, 2 mors mobiles 15mm et tube gainé livré avec CEV39L (voir page 71)	-	CEV605T5U 345 mm Pack 3	-	Rotatif 40 -> 45
 Courbes, 2 mors mobiles 15mm gainage proximal	CEV8605GU 250 mm Pack 3	CEV605GU 350 mm Pack 3	CEV9605GU 450 mm Pack 3	
 Courbes, 2 mors mobiles titane 15mm gainage proximal	CEV8605GTU 250 mm	CEV605GTU 350 mm	CEV9605GTU 450 mm	
 Courbes, 2 mors mobiles 10mm	CEV8604T1U 240 mm	CEV604T1U 340 mm Pack 1 CEV604T3U 340 mm Pack 3	CEV9604T1U 440 mm	

Démontable

Insert proximal	Insert tige			Poignée
2 mors mobiles pour insert tige Echelle 1/1	Longueur utile - Echelle 1/6			N° Pages
	245 mm	345 mm	445 mm	
 CEV607U Courbes type Metzenbaum 15 mm - Pack 6				
 CEV607CU Courbes lames 10mm - Pack 6				
 CEV607DU Droits lames 10mm - Pack 6	Tige seule sans tube gainé - à l'unité CEV8607T1U CEV607T1U CEV9607T1U			  Rotatif 40 -> 45 Non rotatif 46 -> 47
 Courbes type Metzenbaum CEV605BGPU à l'unité CEV605GPU Pack 3				 
	Tige métallique et tube gainé à l'unité CEV8649BGPU CEV649BGPU CEV9649BGPU Pack 3 CEV8649GPU CEV649GPU CEV9649GPU Gaine noire pour insert tige et tube - Pack 3 CEV8649C5U CEV649C5U CEV9649C5U			



Nota:
Pour le nettoyage, l'insert et l'insert tige doivent être démontés.

NON démontable				
Instruments complets				
Mors Echelle 1/1	Poignée	Longueur utile		
		Court	Standard	
 Ciseaux droits lames crantées 10mm	 Revolver	Montupet CEV804 235 mm	Manhès CM104 355 mm	
	 Axiale	CEV904 235 mm		–
 Ciseaux droits lames crantées fines 10mm	 Revolver	–		Manhès CM106 355 mm
 Ciseaux courbes à gauche lames crantées 10mm	 Revolver	–		CEV114MU 355 mm
	 Axiale	–		CEV514MU 335 mm





NON démontable





Instruments complets





Mors Echelle 1/1	Poignée	Longueur utile
 <p>Ciseaux courbes à gauche lames crantées 25 mm</p>	 <p>Revolver</p>	<p>CEV404 340 mm</p>
	 <p>Axiale</p>	<p>CEV503 350 mm</p>



Démontable

 <p>Ciseaux courbes à gauche 2 mors mobiles 25 mm</p>	 <p>Rotatif 44 - 45</p>	<p>CEV653-1 365 mm</p>
--	--	-----------------------------------

Démontable				
Mors Echelle 1/1	Inserts			Poignée
	Longueur utile			N° Pages
	Court	Standard	Long	
 Mors clamp droit vasculaire 25mm	CEV8626I 250 mm	CEV626-1 350 mm	-	 Rotatif 40 -> 45
 Mors clamp courbe vasculaire 2 mors mobiles 25mm	CEV8627I 255 mm	CEV627I 355 mm	CEV9627I 455 mm	Non rotatif 46 -> 47 



NON démontable		
Instruments complets		
Mors Echelle 1/1	Poignée	Longueur utile
		Standard
 Debakey Clamp droit 20mm	 Axiale à crémaillère	Debakey CEV526 350 mm
 Desmaizieres Clamp droit 20mm	 Revolver à crémaillère longue	Desmaizieres CEV527 365 mm











NON démontable

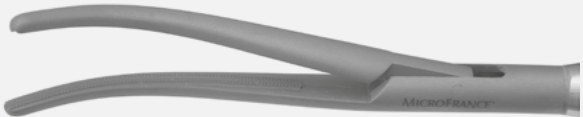



Instruments complets

Mors Echelle 1/1	Poignée	Longueur utile
 <p>Dulucq Courbe à gauche 60mm</p>	 <p>Axiale à crémaillère</p>	<p>Dulucq CEV570 400 mm</p>

Démontable		
Inserts		Poignée
Mors Echelle 1/1	Longueur utile	N° Pages
 <p>Delaitre Courbe à gauche 45mm Ø 10mm</p>	<p>CEV635-1 385 mm</p>	 <p>Rotatif 44 - 45</p> 

NON démontable
Instruments complets



Mors Echelle 1/1	Poignée	Longueur utile
 <p>Querleu Courbe à gauche 45mm Ø 10mm</p>	 <p>Revolver à crémaillère longue</p>	<p>Querleu CEV435-1 375 mm</p>
 <p>Delaitre Courbe à gauche 45mm Ø 10mm</p>	 <p>Axiale à crémaillère avec verrou</p>	<p>Querleu CEV535 385 mm</p>
 <p>Querleu Courbe à droite 45mm Ø 10mm</p>	 <p>Revolver à crémaillère longue</p>	<p>Delaitre CEV505 385 mm</p>
 <p>Courbe 75mm Ø 10mm</p>	 <p>Axiale à crémaillère avec verrou</p>	<p>Querleu CEV435-2 375 mm</p>
		<p>CEVA112 320 mm</p>







Démontable		
Inserts		Poignée
Mors Echelle 1/1	Longueur utile	N° Pages
 <p>Mors clamp droit intestinal 65x7mm - Ø10mm</p>	<p>CEV608-1 400 mm</p>	
 <p>Annibale Mors clamp droit intestinal 2 mors mobiles 65x7mm - Ø10mm</p>	<p>Annibale CEV608D 400 mm</p>	<p>Rotatif 44 - 45</p> 





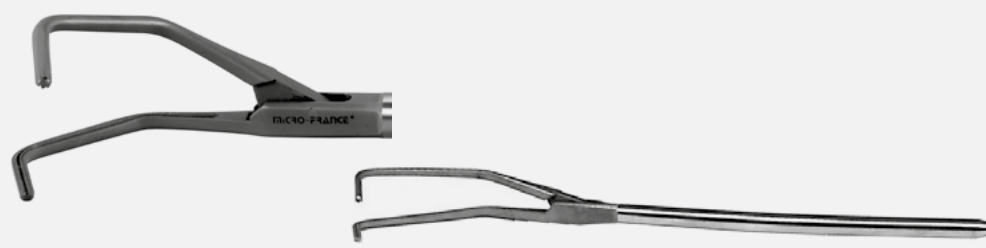

NON démontable



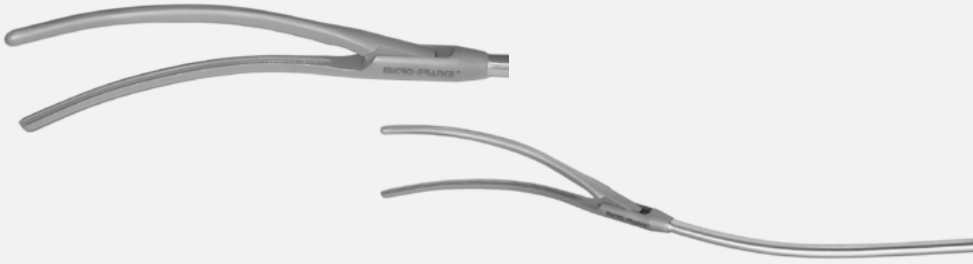

Instruments complets

Mors Echelle 1/1	Poignée	Longueur utile
	 <p>Revolver à crémaillère longue</p>	<p>Delaitre CEV431-65 390 mm</p>
<p>Clamp droit intestinal 65x7mm Ø 10mm</p>	 <p>Axiale à crémaillère avec verrou</p>	<p>CEV508 400 mm</p>

NON démontable			
Instruments complets			
Echelle 1/1	Mors	Poignée	Référence
  <p>Satinsky Clamp courbe tube coudé longueur utile 260 mm mors 110 mm</p>			CEVA101
 <p>Clamp courbe tube coudé longueur utile 250 mm mors 90 mm</p>		 <p>axiale à crémaillère avec verrou</p>	CEVA102
 <p>Satinsky Clamp courbe tube coudé longueur utile 240 mm mors 80 mm</p>			CEVA103
 <p>Clamp courbe tube coudé longueur utile 290 mm mors 110 mm</p>			CEVA104 290 mm



NON démontable			
Instruments complets			
Echelle 1/1	Mors	Poignée	Longueur utile
	 <p>Desmaizieres Clamp courbe tube coudé longueur utile 270 mm mors 85 mm</p>		CEVA110
	 <p>Desmaizieres Clamp courbe tube coudé longueur utile 270 mm mors 90 mm</p>	 <p>axiale à crémaillère avec verrou</p>	CEVA528
	 <p>Desmaizieres Clamp courbe tube coudé longueur utile 220 mm mors 60 mm</p>		CEVA529

Clamp Bull-dog largable

 <p>CEV565 + CEV560</p>			
Mors Echelle 1/1			
	Clamp droit vasculaire 15x3mm Pack 2	Sartori CEV568	
	Clamp droit vasculaire 25x3mm Pack 2	Begin CEV565	
	Clamp pour cholédoque 35x4mm Pack 2	Begin CEV566	
	Clamp intestinal 45x5mm Pack 2	Begin CEV567	

Pince pose-clamps - 10 mm



NON démontable			
Mors Echelle 1/1	Poignée		Longueur utile
 <p>Pince pose-clamp bull-dog Ø 10mm 360mm</p>		Axiale à crémaillère	Begin CEV560 360 mm







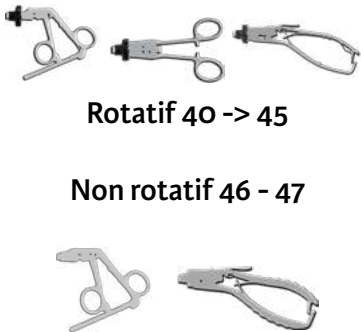

Démontable			
 <p>Insert mors pose-clamp bull-dog pour tube Ø10mm 310mm</p>	 <p>Rotatif 44 - 45</p>		CEV560-1 355 mm

Pince à clips

NON démontable			
Instruments complets			
Mors Echelle 1/1	Poignée		Longueur utile
 <p>Pince applicateur de clips TI300 et LC300 Ø 10mm</p>		<p>Revolver à ressort</p>	<p>CEV310 335 mm</p>

Pince démontable pour enclume

Démontable			
 <p>Morino Insert pour enclume pour suture circulaire 2 mors mobiles Ø 10mm</p>	 <p>Rotatif 46 -> 47</p>	<p>Morino CEV603I 375 mm</p>	
 <p>Massard Insert pour Enclume pour suture circulaire Ø 5mm</p>	 <p>Rotatif 40 -> 45 Non rotatif 46 - 47</p>	<p>Massard CEV622IU 335 mm</p>	

Démontable			
Instruments rotatifs			
Poignées revolver Bague noire de rotation Echelle 1/3			
 Crémaillère externe Poignée deux branches mobiles	CEV1019T5BU Modèle large	 Crémaillère interne Poignée une branche mobile	CEV10195CU
 Crémaillère externe Poignée une branche mobile	CEV10195DU	 Crémaillère externe Poignée une branche mobile	CEV10195RU
 sans crémaillère Poignée deux branches mobiles	CEV1039T5TBU Modèle large	 sans crémaillère Poignée une branche mobile	CEV10395DU
 sans crémaillère Poignée une branche mobile	CEV10395RU	 sans crémaillère Poignée gainée une branche mobile	CEV1039G5U

Tube pour poignée revolver rotative 5 et 3,5mm
Voir page 43

Démontable

Instruments rotatifs

Poignées axiales
Bague noire de rotation
Echelle 1/3

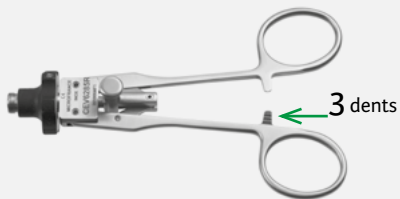

Crémaillère interne 3 dents

CEV6285R

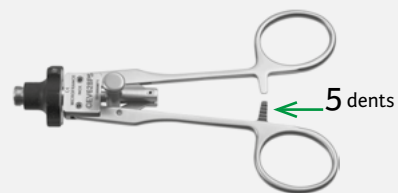

Crémaillère interne longue 5 dents

CEV628P5



Sans crémaillère





CEV6385RU



Crémaillère externe longue

CEV728T5

Tube pour poignée axiale rotative 5 et 3,5mm
Voir page 43

Démontable	
Instruments rotatifs	
Poignées ergonomiques Bague noire de rotation Echelle 1/3	
 Grip large A crémaillère débrayable CEV720BRUC	 Poignée fine A crémaillère débrayable CEV720RU
 Elhadad Poignée fine A crémaillère CEV7285RU	 Grip large A crémaillère débrayable CEV728BR5U

Tube pour poignée ergonomique rotative 5 et 3,5mm
Voir page 43

Tubes gainés - 5 mm

Démontable

Instruments rotatifs

Longueur utile

Court 210mm

Standard 310 mm

Long 410mm



Tube gainé noir

CEV8649T5TBU

CEV649T5BU

CEV9649T5TBU



Tube gainé jaune

CEV8646B5U

CEV646B5U

CEV9646B5U



Tube gainé bleu

CEV8647B5U

CEV647B5U

CEV9647B5U



Tube gainé vert

CEV8648B5U

CEV648B5U

CEV9648B5U

Tube non gainé et boîte de 3 gaines



Tube non gainé à utiliser avec gaine noire

CEV8649B5U

CEV649B5U

CEV9649B5U



Gaine noire pour tube non gainé Pack 3

CEV8649C5U

CEV649C5U







CEV9649C5U

Démontable

Instruments rotatifs

Poignées
Bague grise de rotation
Echelle 1/3



 <p>CEV102910R</p> <p>Poignée revolver, deux branches mobiles Pour tube métallique Ø 5 et 10mm Crémaillère externe longue</p>	 <p>CEV1059-10B</p> <p>Poignée revolver, deux branches mobiles Pour tube métallique Ø 5 et 10mm Sans crémaillère</p>
 <p>CEV628-10</p> <p>Poignée axiale Pour tube métallique Ø 5 et 10mm Crémaillère interne 3 dents</p>	 <p>CEV658-10</p> <p>Poignée axiale Pour tube métallique Ø 5 et 10mm Sans crémaillère</p>
 <p>CEV72810R</p> <p>Poignée Ergonomique fine Pour tube métallique Ø 5 et 10mm Crémaillère débrayable</p>	 <p>CEV728BR</p> <p>Poignée Ergonomique grip large Pour tube métallique Ø 5 et 10mm Crémaillère débrayable</p>
 <p>CEV728T10</p> <p>Poignée axiale Pour tube métallique Ø 5 et 10mm Crémaillère externe longue</p>	<p>Tube pour poignée rotative 5 et 10mm Voir page 45</p>

Démontable

Instruments rotatifs

Longueur utile

Court

Standard

Long



Tube métallique pour instrument rotatif Ø 10mm

CEV864910B
215mm

CEV649-10B
305mm

–







Tube métallique pour instrument rotatif Ø 5mm

CEV8649X5
210mm

CEV649X5
310mm

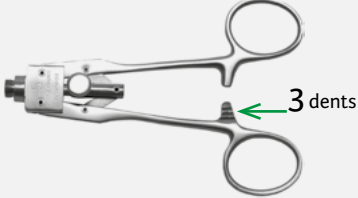
CEV9649X5
410mm

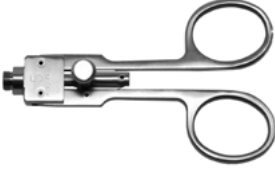
Poignées non rotatives - 5 mm - pour tube gainé

Démontable	
Instruments non rotatifs	
Poignées sans bague de rotation Echelle 1/3	
 Poignée revolver Crémaillère externe longue CEV1019T5NUC	 Poignée axiale Crémaillère interne 3 dents CEV628-5N
 Poignée revolver Crémaillère externe longue CEV10195NAU	 Poignée axiale Sans Crémaillère CEV638T5NU
 Poignée revolver Sans Crémaillère CEV1039T5NU	

Tubes gainés pour instrument non rotatif

 Tube gainé noir pour instrument NON rotatif Ø 5mm		
	Longueur utile	
Court 210mm	Standard 310mm	Long 410mm
CEV8649T5NU	CEV649T5NU	CEV9649T5NU

Poignées non rotatives - 5 mm - pour tube métallique Ø 5mm

Démontable

Instruments non rotatifs

Poignées sans bague de rotation
Echelle 1/3



CEV720

Poignée ergonomique fine
Crémaillère débrayable externe longue

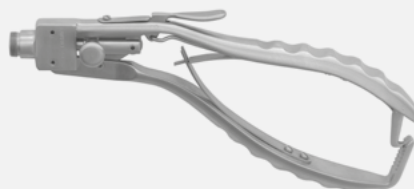

CEV720B

Poignée ergonomique grip large
Crémaillère débrayable externe longue

Tubes métalliques Ø 5mm pour instrument non rotatif



Tube métallique pour instrument NON rotatif Ø 5mm

Longueur utile

Court 210mm

Standard 310mm

Long 410mm

CEV8649P5

CEV649P5

CEV9649P5

Câbles bipolaires 4,5 m



CP393-2

Bowa Emc Lamidey Valleylab



CP393-3

Erbe VIO ICC ACC
(sauf international)
Storz Wolf



CP393-4

Aesculap Berchtold Martin
Sutter BM 780 II

Démontable









Inserts & Tubes

Poignées

Non rotatif

	Mors Echelle 1/1	Longueur utile						
		Court		Standard		Long		
		Mors	Tube 1/3	Mors	Tube 1/3	Mors	Tube 1/3	
		CEV86341A 245 mm		CEV634-1A 340 mm		CEV9634-1A 430 mm		
	Mouiel 15x5mm							CEV669B Poignée revolver
		-		CEV632-1A 340 mm		CEV96321A 430 mm		
	avec bec 15x5mm							CEV669BG Gayet Poignée Ergonomique
	CEV86361A 250 mm			CEV636-1A 345 mm		CEV96361A 435 mm		
Gayet 20x5mm								MCEN54P Dessi Poignée revolver
	-		CEV86795B 210 mm	CEV6371 345 mm				
Vallancien A Griffes 20x5mm					CEV6795B 310 mm			
						CEV96795B 395 mm		











NON démontable				
Instruments complets				
Mors Echelle 1/1	Poignée	Longueur utile		
		Court	Standard	Long
 15x5mm	 Revolver	CEV834 240 mm	Mouiel CEV134 360 mm	–
	 Ergonomique et tube avec graduation à 100mm	–	Gayet CEV134BG 360 mm	Gayet CEV9134BG 450 mm
	 Axiale	–	CEV580-2 365 mm	–
 15x5mm avec bec	 Revolver	–	CEV132 360 mm	–
 Gayet 20x5mm	 Revolver	–	Gayet CEV136 365 mm	–











Démontable

Inserts & Tubes

Poignées Non rotatif

Mors Echelle 1/1	Longueur utile				
	Standard		Long		
	Mors	Tube 1/3	Mors	Tube 1/3	
 <p>Manhès mors striés spatulés 10x3mm</p>	CEV630-1A 340 mm		CEV9630-1A 425 mm		 <p>CEV669B Poignée revolver</p>
 <p>Botella Mors fenêtrés triangulaires 12x5mm</p>	CEV633-1A 340 mm		CEV96331A 430 mm		 <p>Gayet CEV669BG Poignée Ergonomique</p>
 <p>Mors spatulés coudés 10x2mm</p>	CEV630C 340 mm		CEV6795B 310 mm		 <p>MCEN54P Dessi Poignée revolver</p>



NON démontable				
Instruments complets				
Mors Echelle 1/2	Poignée	Longueur utile		
		Court	Standard	
 10x3mm	 Revolver	Montupet CEV830 240 mm	Manhès CEV130 360 mm	
 Botella Mors fenêtrés triangulaires 12x5mm	 Revolver	-		Botella CEV133 360 mm
	 Axiale	-		Bottela CEV580-3 360 mm
-	-	-	-	
 8x5mm	 Revolver	-		Botella CEV133-1 360 mm
 Manhès 10x2mm	 Revolver	-		Manhès CM131 360 mm



Démontable

Mors de crochet

Echelle 1/1



CEV229-2A
Crochet n° 2
Pack 3



CEV229-3A
Crochet n° 3
Pack 3



CEV229-4A
Crochet n° 4
Pack 3



CEV2295A
Crochet n° 5
Pack 3

Manche de crochet

Echelle 1/3

CEV225A

Longueur utile 430mm



CEV82291

Longueur utile 230mm



CEV229-1A

Longueur utile 350mm



CEV9229-1

Longueur utile 450mm

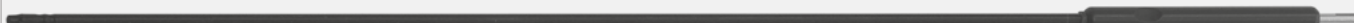

CEV229B

Longueur utile 380mm



Page 54

Crochet non démontable

Echelle 1/3

1/1



CEV225

Longueur utile 430mm



1/1



Périssat
CEV230-1

Longueur utile 330mm

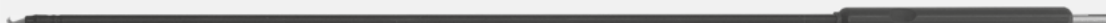

1/1



Montupet
CEV825

Longueur utile 220mm



Bistouris rétractables

		NON démontable	
		Instruments complets	
1/3			
	1/1		CEV135-5 Bistouri à lame rétractable Ø 5mm 300mm livré sans lames SM63 / SM64 / SM65
1/3			
	1/1		CM109 Manhès Bistouri pointe monopolaire rétractable Ø 5mm 320mm









Palpateur monopolaire

1/3			
	1/1		CEV443 Delaitre Palpateur boutonnée monopolaire Ø 5mm 350mm





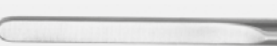



^(D) Distribué par Integra MicroFrance SAS (France) - Voir tableau d'équivalence annexe pour la référence du fabricant correspondante
* Veuillez vérifier auprès de votre représentant commercial la disponibilité de ce produit dans votre pays

Palpeurs

	1/3				
	1/1		CEV204 320 mm - Ø 5mm	Palpeur boutonné	
	1/1		CEV204G45 450 mm - Ø 5mm	Palpeur boutonné avec graduation de 10 à 150 mm	
	1/1		CEV205 340 mm - Ø 5mm	Palpeur spatulé	
	1/3				
	1/1		CEV207 410 mm - Ø 5mm	Palpeur double, boutonné / spatulé, avec graduation de 10 à 150 mm	

Ecarteurs

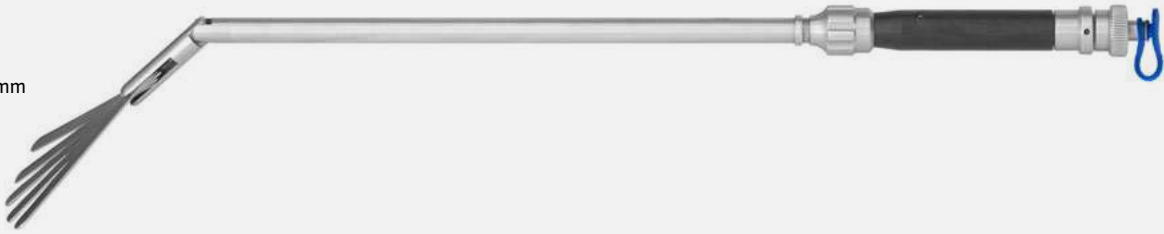
			Ecarteur rétracteur articulé CEV416 380mm - Ø 5mm		1/3
			Ecarteur à 3 palettes 35mm CEV413 370mm - Ø 5mm		1/3
	Nouaille		Ecarteur rétracteur en losange CEV425 320mm - Ø 5mm		1/3
			Ecarteur à 3 palettes 65mm CEV423 400mm - Ø 10mm		1/3
			Ecarteur à 5 palettes 65mm CEV453 400mm - Ø 10mm		1/3
			Ecarteur rétracteur articulé 5 palettes 65mm modèle Strasbourg CEV453A 330mm - Ø 10mm		1/3



NON démontable

Instruments complets

Bras articulé flexible de Mosnier livré avec porte-instrument CEV980-3

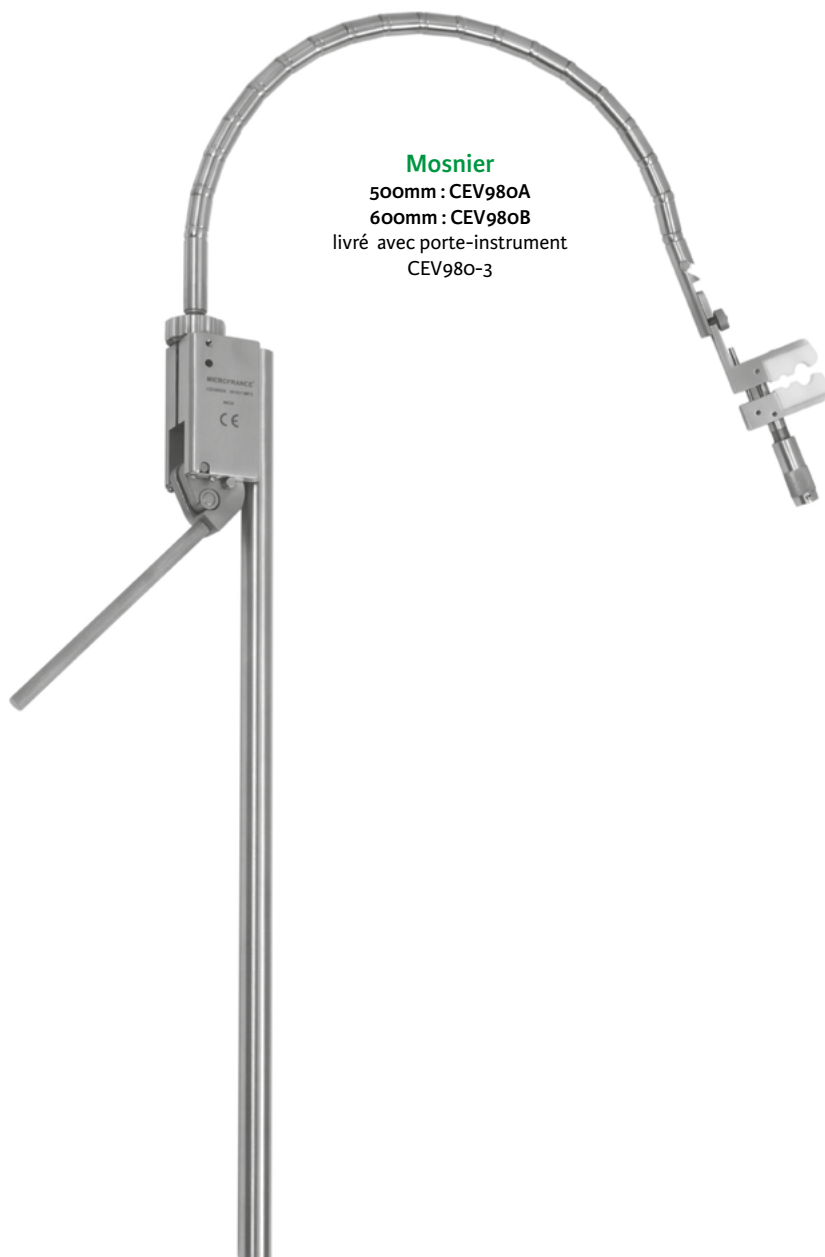

Mosnier
500mm : CEV980A
600mm : CEV980B
livré avec porte-instrument
CEV980-3

Accessoires pour bras articulé

CEV980-3
Porte-instruments
Ø 5 et 10mm
Mosnier



CEV984
Cavalier à vis



CEV985
Cavalier
autobloquant



Accessoires du laveur aspirateur CM201**

Tubulures aspiration irrigation
stériles - Pack 10

CM217S^(D)*





Aspirateurs irrigateurs pour poignée CM201-9**

1/1

«L» Longueur utile

1/3

<p>Hydro à crépine Ø 10mm</p> 	<p>CM20132H10 L 320mm</p> <p>CM20128H-10 L 280mm</p>	
<p>Hydro à crépine Ø 5mm</p> 	<p>CM20132H-5 L 320mm</p> <p>CM20128H-5 L 280mm</p> <p>CM20140H5 L 400mm</p>	
<p>A crépine Ø 5mm</p> 	<p>CM20132L-5 L 320mm</p>	

Chemise lavante pour optique

Chemise pour optique 0°
Ø 10mm 300mm
Echelle 1/3

CEV81



^(D) Distribué par Integra MicroFrance SAS (France) - Voir tableau d'équivalence annexe pour la référence du fabricant correspondante







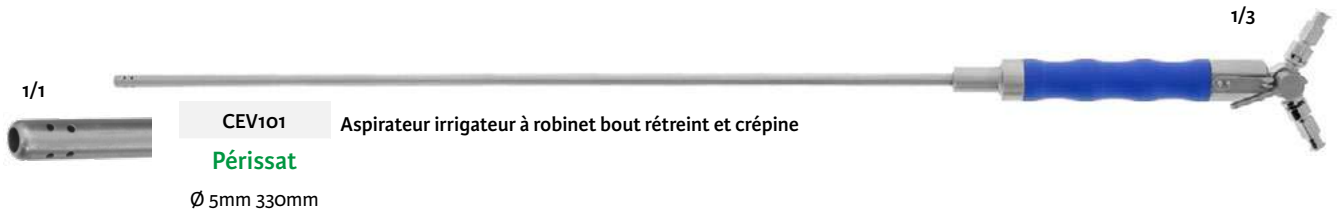



* Veuillez vérifier auprès de votre représentant commercial la disponibilité de ce produit dans votre pays

** Référence discontinuée

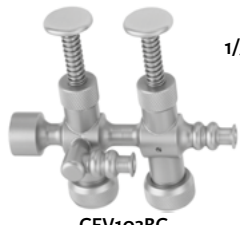
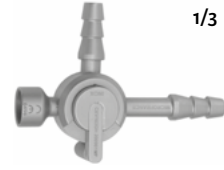



Aspirateur irrigateur standard



Aspirateur irrigateur démontable

Aspirations Ø 5mm		Poignées pour aspiration Ø 5mm
<p>1/1  1/3 </p> <p>195mm CEV8103D5</p> <p>295mm CEV103-5</p> <p>395mm CEV9103D5</p>	<p>1/3  CEV103AH</p>	
<p>1/1  Bout rétreint 1/3 </p> <p>195mm CEV8103G5</p> <p>295mm CEV103G5</p> <p>395mm CEV9103G5</p>	<p>1/3  CEV103BG</p> <p>1/3  CEV103GH</p>	
Aspirations Ø 10mm		Poignée pour aspiration Ø 10mm
<p>1/1  CEV103-10 1/3  295mm</p> <p>1/1  CEV103P 1/3  Prete 410mm</p>	<p>1/3  CEV103AH</p>	





Passe-fil

	articulé	CEV438 420mm - Ø 10mm Bertrand		1/3
	articulé	CEV438B Longueur utile 335mm - Ø 5mm		1/3
	rétractable	CEV438D5 430mm - Ø 5mm Morino		1/3
	rétractable	CEV456 170mm - Ø 2,5mm		1/3

Set de Mintz pour ponction

Chemise - Ø 2,5mm - 240mm	CM170-1		1/3
Mandrin pointu	CM170-2		
Mandrin mousse	CM170-3		

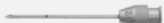
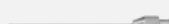
Aiguilles

Aiguille à insufflation luer-lock		1/3	
120mm	CEV60-120		
150mm	CEV60-150		
Aiguille à ponction luer-lock		1/3	
Ø 5mm - 300mm	CEV65		
Ø 1,2mm - 40mm	CEV24F		
Ø 2,0mm - 40mm	CEV24G		
	avec perforation latérale pour purge		2/1

Cholangiographie

1/3

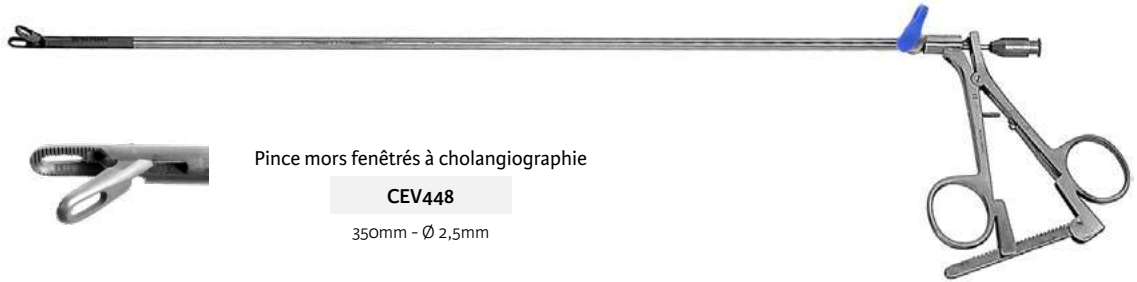

1/1



Pince mors fenêtrés à cholangiographie

CEV448

350mm - Ø 2,5mm

1/3



Aiguille à cholangiographie

CEV440

230mm - int Ø 2,5mm

Joint

CEV440P6

Pack 6



1/3

Chemise-guide à cholangiographie

CEV455

170mm - Ø 4,0mm

Falchero



Joint

CEV103P6

Pack 6

Cholédoscopie

1/3

Mauras

Chemise-guide à cholédoscopie

CEV449

190mm - Ø 8mm

avec mandrin CEV449G



1/3

Pièces détachées

Mandrin blanc pour chemise CEV449

CEV449G

400mm

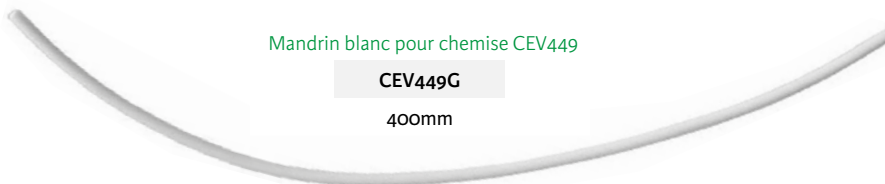

Joint

CEV105P6







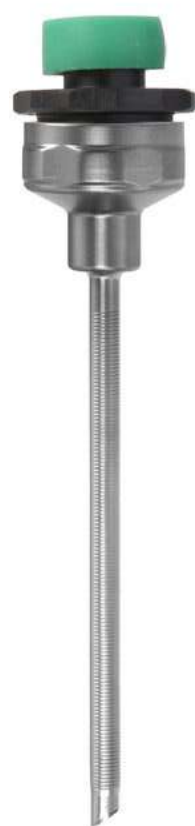



Pack 6



Trocart métal









Echelle 1/1

			Longueur utile	
			50 mm	80 mm
Mandrin		mousse 	CEV8143A4	CEV143A4
		pointu 	CEV8143A3	CEV143A3
Joint capuchon	Vert 	CEV103P6 Boîte 6		
Tête de trocart	à valve aimantée 	CEV177A3 livré complet avec une valve aimantée et un joint capuchon vert		
	à valve silicone 	CEV127T3 livré complet avec une valve silicone et un joint capuchon vert		
Valve pour tête de trocart	Aimantée 	CEV179A5 Boîte 6		
	Silicone 	CEV125P6 Boîte 6		
Chemise métal crénelée	Avec robinet 	CEV8143A7	CEV143A7	
	Sans robinet 	CEV8143B7	CEV143B7	

Trocart composite à valve silicone















			Longueur utile	
			45 mm	70 mm
Mandrin 	mousse 		CEV8826M	CEV326M
	pointu 		CEV8826P	CEV326P
Joint capuchon	Vert 		CEV103P6 Boîte 6	
Valve pour tête de trocart	Silicone 		CEV125P6 Boîte 6	
Corps de trocart composé d'une tête de trocart avec chemise composite à valve silicone	avec chemise lisse sans robinet 		CEV8826L	CEV326L
	avec chemise à pas de vis sans robinet 		CEV8826V	CEV326V



Echelle 1/1















CEV8126V

			Longueur utile			
			50 mm	80 mm	100 mm	120 mm
Mandrin 	mousse conique 		CEV8145A5	CEV145A5	CEV7145A5	CEV9145A5
	pointu 		CEV8145A3	CEV145A3	CEV7145A3	CEV9145A3
Joint capuchon	Bleu 		CEV105P6 Pack 6			
Tête de trocart 	à valve aimantée		CEV177A5 livré complet avec une valve aimantée et un joint capuchon bleu			
	à valve silicone 		CEV127T livré complet avec une valve silicone et un joint capuchon bleu			
Valve pour tête de trocart	Aimantée 		CEV179A5 Pack 6			
	Silicone 		CEV125P6 Pack 6			
Chemise	Avec robinet	A pas de vis 	CEV8145A6	CEV145A6	CEV7145A6	CEV9145A6
		Lisse 	CEV8145A7	CEV145A7	CEV7145A7	CEV9145A7
	Sans robinet	A pas de vis 	CEV8145B6	CEV145B6	CEV7145B6	CEV9145B6
		Lisse 	CEV8145B7	CEV145B7	CEV7145B7	CEV9145B7

Corps de trocart 5 mm à valve silicone avec chemise à pas de vis sans robinet 	1/2 CEV126V	CEV8126V Longueur utile 45 mm Montupet	CEV126V Longueur utile 75 mm
Mandrin pour corps de trocart diamètre 5 mm 	mousse conique 	CEV8126PM Longueur utile 95 mm Montupet	CEV126PM Longueur utile 120 mm
	pointu 	CEV8126P Longueur utile 95 mm	CEV126P Longueur utile 120 mm



Echelle 1/1

			Longueur utile	
			90 mm	130 mm
Mandrin		mousse 	CEV150-4	CEV9150A4
		pointu 	CEV150-3	CEV9150A3
Joint capuchon		Rouge 	CEV110P6 Pack 6	
Tête de trocart		à valve aimantée 	CEV177A10 livré complet avec une valve aimantée et un joint capuchon rouge	
		à valve silicone 	CEV127T10 livré complet avec une valve silicone et un joint capuchon rouge	
Valve pour tête de trocart		Aimantée 	CEV179A10 Pack 6	
		Silicone 	CEV125Q6 Pack 6	
Chemise	Avec robinet	A pas de vis 	CEV150A6	CEV9150A6
		Lisse 	CEV150A7	CEV9150A7
	Sans robinet	A pas de vis 	CEV150B6	CEV9150B6
		Lisse 	CEV150B7	CEV9150B7

Mandrin de trocart mousse palpateur de Dulucq

Echelle 2/3

Dulucq















CEV480







Ø 10 mm

Longueur utile 180mm



Echelle 1/1

			Longueur utile	
			90 mm	130 mm
Mandrin 	mousse 	CEV172A4	CEV9172A4	
	pointu 	CEV172A3	CEV9172A3	
Joint capuchon	Orange 	CEV112P6 Pack 6		
Tête de trocart	à valve aimantée 	CEV177A12 livré complet avec une valve aimantée et un joint capuchon orange		
	à valve silicone 	CEV127T12 livré complet avec une valve silicone et un joint capuchon orange		
Valve pour tête de trocart	Aimantée 	CEV179A12 Pack 6		
	Silicone 	CEV125Q6 Pack 6		
Chemise	Avec robinet	A pas de vis 	CEV172A6	CEV9172A6
		Lisse 	CEV172A7	CEV9172A7
	Sans robinet	A pas de vis 	CEV172B6	CEV9172B6
		Lisse 	CEV172B7	CEV9172B7

	Ø 5,5 mm			Ø 10,5 mm		Ø 12,5 mm	
1/3	CEV805I	CEV105	CEV105I	CEV110I	CEV112I	CEV122I	CEV212
							
	Longueur utile 50mm avec robinet	Longueur utile 80mm sans robinet	Longueur utile 80mm avec robinet	Longueur utile 80mm avec robinet	Longueur utile 120mm avec robinet	Longueur utile 80mm avec robinet	Longueur utile 120mm sans robinet
	Montupet						

Ressort pour trocart à piston



CEV105R
Ø 5,5mm



CEV110R
Ø 10,5mm



CEV112R
Ø 12mm

Joint pour trocart à piston
voir page 68



			Diamètre		
			5,5mm diam.	10mm diam.	12,5mm diam.
Mandrin	mousse		CEV145-4	CEV150-4	-
	pointu		CEV145-3	CEV150-3	CEV172-3
Joint capuchon					
			CEV105P6 Pack 6	CEV110P6 Pack 6	CEV112P6 Pack 6
Tête de trocart	avec robinet				
	sans robinet			-	
			CEV178-5	CEV278-10	CEV278-12
			CEV177-5	-	CEV177-12
Chemise	Sans robinet	A pas de vis			
		Lisse			-
			CEV145-6	CEV150-6	CEV172-1
			CEV145-7	CEV150-7	-

Joint pour trocart



CEV103P6

Ø 3,5mm

Pack 6



CEV105P6

Ø 5,5mm

Pack 6



CEV110P6

Ø 10,5mm

Pack 6



CEV112P6

Ø 12mm

Pack 6

Réducteur Trocart

1/1



CEV155A

de Ø 10,5 à 5,5mm



CEV156A

de Ø 12/13 à 5,5mm



CEV181A

de Ø 12/13 à 10,5mm

1/3



CEV153

135 mm

de Ø 5,5 à 3,5mm



CEV155

135 mm

de Ø 10,5 à 5,5mm



CEV155-1

65 mm

de Ø 10,5 à 5,5mm



CEV155P

135 mm

de Ø 12/13 à 5,5mm

Tube
interne
Ø 5mm



CEV156

135 mm

de Ø 12/13 à 10,5mm



CEV181

135 mm

de Ø 12/13 à 10,5mm



CEV181-1

65 mm

de Ø 12/13 à 10,5mm

Ecarteurs double "Open laparo"

1/3



Descottes

CEV417

200 mm

Paire

Ecarteur double de Descottes, 2 valves mousses



CEV418

200 mm

Paire

Ecarteur double, 2 valves mousses



Mosnier

CEV419

160 mm

Paire

Ecarteur double de Mosnier, 2 valves mousses

Trocarts 85mm

Echelle 1/3	Mandrin Mousse	Mandrin Pointu	Chemise à pas de vis
Ø 5,5mm	CET105-1 	CET105-2 	CET105-3
Ø 10,5mm	CET110-1 	CET110-2 	CET110-3
Ø 12,5mm	CET112-1 	CET112T2 	CET112-3

Joints : voir page 68

Instruments complets non démontables diamètre 5 mm

Mors Echelle 1/1	Poignée	Référence
 Manhès Mors curescopes 12x5mm Longueur utile 355mm	 Revolver	CM107U
 Mors curescopes 12x5mm, 2 mors mobiles Longueur utile 355mm	 Revolver	CEV444
 Mors fenêtrés 20x5mm, tube courbe Longueur utile 340mm	 Axiale à crémaillère Tube courbe	CET525

Pince modulaire démontable

Mors Echelle 1/1	Poignée	Longueur utile		
		court	standard	long
 Manhès Mors curescopes 12x5mm Ø 5mm	 Rotatif : page 40 - 45 Non rotatif : page 46 - 47	CEV8107IU 245mm	CEV107IU 345mm	CEV9107IU 445mm



Belghiti	Soubrane	CEV392P20	Dousset	Gayet	Partenski
215mm	215mm	215mm	290mm	220mm	190mm
CEV392D20	CEV392S20	CEV392P20	CEV392D30	CEV392G24	CEV392R15
droite	droite	droite	droite	droite	baïonnette
mors 2mm	mors 2mm double irrigation	mors striés 2mm	mors 3mm double irrigation	mors 5x15mm	mors 4x10mm

Câbles bipolaires - 4,5 m



CP393-2
Bowa Emc Lamidey Valleylab













CP393-3
Erbe VIO ICC ACC (sauf international) Storz Wolf



CP393-4
Aesculap Berchtold Martin Sutter BM-78o II











Semi-démontable

Inserts - Tubes		Poignée
Mors avec tube gainé Echelle 1/1	Longueur utile	N° Pages
 Insert Babcock	CEV391IU 335 mm	 Rotatif 40 -> 45
 Insert ciseaux courbes lames crantées 8 mm	CEV393IU 330 mm	
 Insert ciseaux droits lames crantées 8mm	CEV394IU 330 mm	
 Insert mors fenêtrés 3x12mm	CEV395IU 335 mm	
 Insert mors striés alligator 6 mm	CEV396IU 330 mm	
 Insert dissecteur courbure moyenne à gauche 10 mm	CEV398IU 340 mm	
 Insert mors à griffes grip-pince	CEV399IU 335 mm	
	CEV39L Raccord luer lock pour lavage insert et tube	



NON démontable













Instruments complets

Mors Echelle 1/1	Poignée	Longueur utile
 Pince mors Babcock	 Revolver avec crémaillère longue	CEV391BU 355 mm
-	-	-
 Ciseaux droits s lames crantées 8mm	 Revolver,	CEV394BU 350 mm
 Pince mors fenêtrés 3x12mm	 Revolver avec crémaillère longue	CEV395BU 355 mm
-	-	-
-	-	-
 Pince mors à griffes grip-pince	 Revolver avec crémaillère longue	CEV399BU 355 mm
 Porte-aiguille mors droits tungstène	 Axiale	CEV992B 340 mm
 Porte-aiguille mors courbes tungstène		CEV992C 340 mm



NON démontable

Instruments complets : Pinces bipolaires

Mors Echelle 1/1	Poignée	Longueur utile
 Gayet Pince mors fenêtrés bipolaires 10x3mm, tube gradué à 100mm	 Ergonomique, bipolaire	CEV397BG 305mm
 Pince mors fenêtrés bipolaires 10x3mm, tube gradué à 100mm	 Ergonomique, bipolaire	1/3
 Pince mors striés spatulés bipolaires	 Ergonomique, bipolaire	CEV397C 305mm
 Pince mors striés spatulés bipolaires	 Ergonomique, bipolaire	1/3
 Pince mors striés bipolaires 1,5mm	 Revolver, bipolaire	CEV397 305mm
 Pince mors striés bipolaires 1,5mm	 Revolver, bipolaire	1/3

Pince de Cadière



Pince sans trocart
Pince mors fenêtrés
percutanés

CEV350

1/1

195mm



Cadière

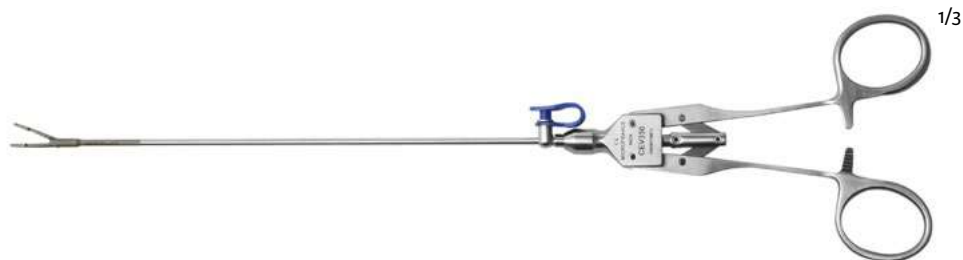

1/3

Palpateur



Palpateur boutonné Ø 3,5mm 330mm

CEV203

1/1



1/3

Crochets monopolaires



1/1



CEV390B Ø3,5mm, Longueur utile 330mm, arrondi

1/3

1/1



CEV390C Ø3,5mm Longueur utile 355mm, 90°

1/3



Page 54

Aspirateurs irrigateurs



Aspirateur irrigateur gradué 50/100/150mm bout rétreint et crépine

1/1



CEV103G3

Ø 3,5mm 295mm



1/3

Canule graduée pour poignée CEV103GH ou CEV103BG

Poignées de commande pour aspirateur CEV103G3



CEV103GH



CEV103BG

1/3

Pousse-noeud de Iannelli



1/1



CEV342

440mm Longueur utile 340mm Ø 3,5mm

1/3

1/1











CEV342E

360mm Longueur utile 340mm Ø 3,5mm

1/3

Trocart métal

Longueur utile	
50 mm	80 mm

Mandrin	mousse		CEV8143A4	CEV143A4
	pointu		CEV8143A3	CEV143A3
Joint capuchon	Vert		CEV103P6 Pack 6	
Tête de trocart	à valve aimantée		CEV177A3 livré complet avec une valve aimantée et un joint capuchon vert	
	à valve silicone		CEV127T3 livré complet avec une valve silicone et un joint capuchon vert	
Valve pour tête de trocart	Aimantée		CEV179A5 Pack 6	
	Silicone		CEV125P6 Pack 6	
Chemise métal crénelée	Avec robinet		CEV8143A7	CEV143A7
	Sans robinet		CEV8143B7	CEV143B7

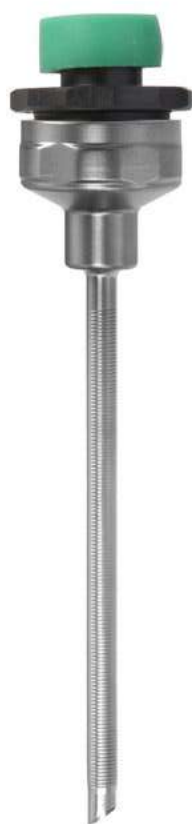







Echelle 1/1

Trocart composite à valve silicone



Echelle 1/1

			Longueur utile	
			45 mm	70 mm
Mandrin 	mousse 	CEV8826M	CEV326M	
	pointu 	CEV8826P	CEV326P	
Joint capuchon	Vert 	CEV103P6 Pack 6		
Valve pour tête de trocart	Silicone 	CEV125P6 Pack 6		
Corps de trocart composé d'une tête de trocart avec chemise composite à valve silicone	avec chemise lisse sans robinet 	CEV8826L	CEV326L	
	avec chemise à pas de vis sans robinet 	CEV8826V	CEV326V	

Crochet monopolaire

	1/1		CEV890 225mm Ø 3,5mm	Montupet		1/3
	1/1		CEV890C 90° 225mm Ø 3,5mm			1/3

Page 54

Bistouri à lame rétractable

			CEV898 90mm Ø 3,5mm Livré avec une lame CEV898L			1/3
	1/1		CEV898L Lame de bistouri pour pylorotome Pack 3			







Aspirateurs irrigateurs

	1/1		CEV8103G3 Ø 3,5mm 195mm	Aspirateur irrigateur gradué 50/100/150mm bout rétreint et crépine Canule graduée pour poignée CEV103GH ou CEV103BG		1/3
					CEV103GH Poignée de commande	
						1/3
					CEV103BG Poignée de commande	
1/1		CEV896 Ø 3,5mm 220mm	Aspirateur irrigateur à robinet bout rétreint et crépine			1/3















NON démontable

Instruments complets : pinces bipolaires

Mors Echelle 1/1	Poignée	Longueur utile
 Pince mors striés bipolaires 1,5mm	 Revolver, bipolaire	CEV897 250 mm
 Pince mors fenêtrés bipolaires 10x3mm	 Ergonomique, bipolaire	CEV897BG 250 mm
 Pince mors spatulés bipolaires 2,0mm	 Ergonomique, bipolaire	CEV897C 250 mm











Semi-démontable

Inserts - Tubes		Poignée
Mors avec tube gainé Echelle 1/1	Longueur utile	N° Pages
 Insert Babcock	CEV891IU 235 mm	   Rotatif 40 -> 45
 Insert ciseaux courbes lames crantées 8 mm	CEV893IU 230 mm	
 Insert ciseaux droits lames crantées 8mm	CEV894IU 230 mm	
 Insert mors fenêtrés 3x12mm	CEV895IU 235 mm	
 Insert mors à griffes grip-pince	CEV899IU 220 mm	
 Insert mors striés alligator 6 mm	CEV896IU 235 mm	
 Insert dissecteur passe-fil courbure moyenne à gauche 10 mm	CEV898IU 230 mm	
	CEV39L Raccord luer lock pour lavage insert et tube	



NON démontable

Instruments complets









Mors Echelle 1/1	Poignée	Longueur utile
 Montupet Pince mors Babcock	 Revolver avec crémaillère longue	CEV891MU 200 mm
—	—	—
 Montupet Ciseaux droits lames crantées 8mm	 Revolver	CEV894MU 220 mm
 Montupet Pince mors fenêtrés 3x12mm	 Revolver avec crémaillère longue	CEV895MU 195 mm
 Pince mors à griffes grip-pince	 Revolver avec crémaillère longue	CEV899U 220 mm









NON démontable

Instruments complets

Instruments de De Lagausie

Mors Echelle 1/1	Poignée	Longueur utile
 De Lagausie Pince mors fenêtrés 3x12mm	 Axiale	CEV995MU 220 mm
 De Lagausie Ciseaux droits lames crantées 8mm	 Axiale	CEV996MU 220 mm
 De Lagausie Pince mors striés alligator 6mm	 Axiale	CEV997MU 210 mm
 De Lagausie Dissecteur courbure moyenne à gauche 10mm	 Axiale	CEV998MU 220 mm

Porte-aiguille

 Montupet Porte-aiguille mors droits tungstène	 Revolver avec crémaillère longue	CEV892 220 mm
 Reinberg Porte-aiguille mors droits	 Axiale	CEV992 220 mm
 Porte-aiguille mors courbes tungstène	 Axiale	CEV992D 220 mm

Ciseaux courbes 2 mors mobiles titane 15 mm

Echelle 1/3



Longueur utile 230 mm

CEC8605GT

Pince mors à griffes Adson-Brown



Longueur utile 230 mm

CEC8522

Porte-aiguille mors droits tungstène 1 x 10 mm



Longueur utile 230 mm

CEC8500T5

Porte-aiguille mors droits automatiques titane



Longueur utile 230 mm

CEC8650T

Echelle 1/2

Longueur utile «L»



Bague de fixation
pour trocart Ø 10mm

MCLP70

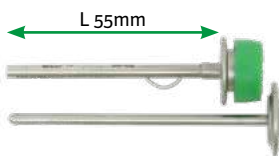

Trocart complet sans valve
avec mandrin mousse

MCLP10

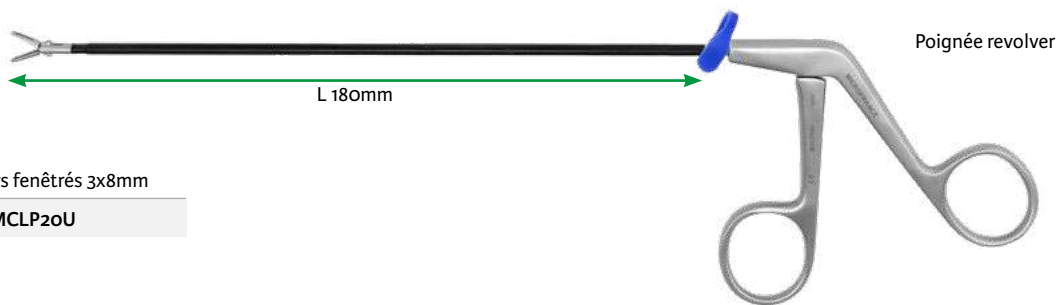

Pince mors fenêtrés 3x8mm

MCLP20U

Poignée revolver



Pince mors fenêtrés 3x8mm

MCLP25U



Pince mors striés alligator 6mm

MCLP30U

MCLP30U

Poignée axiale



Ciseaux courbes à droite lames 4mm

MCLP40U



MCLP40U

Poignée axiale



Crochet monopolaire

MCLP50



MCLP50

Page 54

Palpateur boutoné

MCLP60



MCLP60

L 180mm

Ecarteur double
2 valves mousses
180mm

MCLT10

petite taille 8x35 / 15x40mm

MCLT11

grande taille 8x35 / 15x50mm



Décolleur courbe
190mm

MCLT20

2mm

MCLT21

4mm



Porte-boule de coton



200mm - Ø 3mm

MCLT30

Poignée axiale



Décolleur Aspirateur
200mm - Ø 3mm

MCLT40

malléable, à soupape



Aspirateur à soupape et crépine
200mm - Ø 3mm

MCLT50

malléable



Pince à biopsie rectale 5mm de Scheye
maladie de Hirschsprung

1/3



Inserts mors curettes et tube Ø5mm non stériles usage unique (Bte 3) pour biopsie



Poignée non stérile restérilisable

1/4

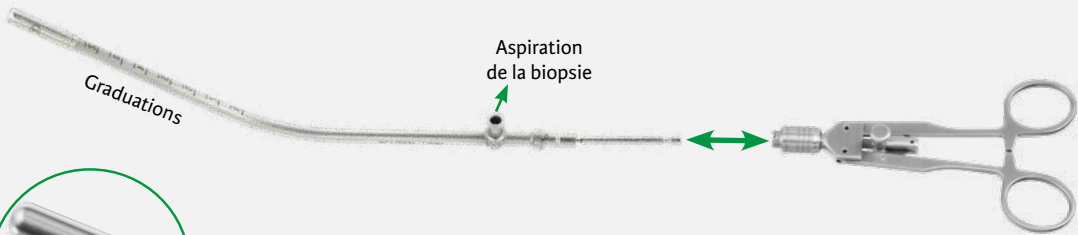

Diamètre biopsie
3 ou 5mm

CEV504S3 Insert Ø3mm

CEV504S5 Insert Ø5mm

CEV504PS Poignée axiale



Précaution:

Si le symbole d'usage unique est représenté sur l'étiquette du dispositif, cela signifie que ce produit est strictement réservé à l'usage d'un patient unique. Ne pas réutiliser, retraiter ni restériliser ce produit. La réutilisation, le retraitement ou la restérilisation du dispositif risque de compromettre son intégrité et/ou de le contaminer, ce qui peut entraîner des blessures, des maladies ou le décès du patient.

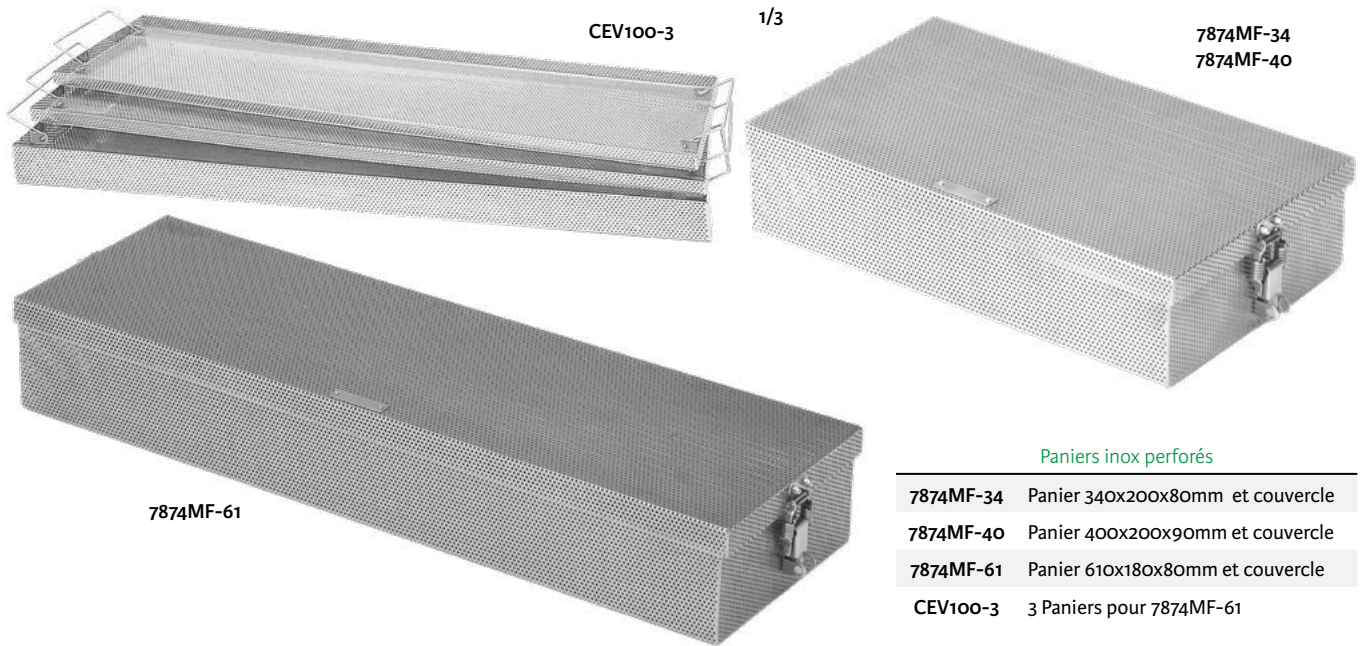

Paniers inox perforés

7874MF-34	Panier 340x200x80mm et couvercle
7874MF-40	Panier 400x200x90mm et couvercle
7874MF-61	Panier 610x180x80mm et couvercle
CEV100-3	3 Paniers pour 7874MF-61



3717001
Panier 530x255x150mm et couvercle, 3 niveaux



CEV56
Capuchon inox
pour raccord luer-lock
instruments non démontables
Pack 1



CEV57
Capuchon silicone
pour raccord luer-lock
instruments non démontables
Pack 6

Index numérique

3

3717001 86

7

7874MF-34 86
7874MF-40 86
7874MF-61 86

CEC

CEC8500T5 82
CEC8522 82
CEC8605GT 82
CEC8650T 82

CET

CET105-1 69
CET105-2 69
CET105-3 69
CET110-1 69
CET110-2 69
CET110-3 69
CET112-1 69
CET112-3 69
CET112T2 69
CET525 69

CEV

CEV24F 59
CEV24G 59
CEV39L 26,71,79
CEV56 86
CEV57 86
CEV60-120 59
CEV60-150 59
CEV65 59
CEV81 57
CEV100-3 86
CEV101 58
CEV103-5 58
CEV103-10 58
CEV103AH 58
CEV103BG 58,74,77
CEV103G3 74
CEV103G5 58
CEV103GH 58,74,77
CEV103P 58
CEV103P6 60,61,62,68,75,76
CEV104IU 26
CEV105 66
CEV105I 66
CEV105P6 63,67,68
CEV105R 66
CEV107IU 69
CEV110I 66
CEV110P6 64,67,68

CEV110R 66
CEV112I 66
CEV112P6 65,67,68
CEV112R 66
CEV114MU 28
CEV122I 66
CEV125P6 61,62,63,75,76
CEV125Q6 64,65
CEV126P 63
CEV126PM 62
CEV126V 63
CEV127T 63
CEV127T3 61,75
CEV127T10 64
CEV127T12 65
CEV130 52
CEV132 50
CEV133 52
CEV133-1 52
CEV134 50
CEV134BG 50
CEV135-5 54
CEV136 50
CEV143A3 61,75
CEV143A4 61,75
CEV143A7 61,75
CEV143B7 61,75
CEV145-3 67
CEV145-4 67
CEV145-6 67
CEV145-7 67
CEV145A3 63
CEV145A5 63
CEV145A6 63
CEV145A7 63
CEV145B6 63
CEV145B7 63
CEV150-3 64,67
CEV150-4 64,67
CEV150-6 67
CEV150-7 67
CEV150A6 64
CEV150A7 64
CEV150B6 64
CEV150B7 64
CEV153 68
CEV155 68
CEV155-1 68
CEV155A 68
CEV155P 68
CEV156 68
CEV156A 68
CEV172-1 67
CEV172-3 67
CEV172A3 65
CEV172A4 65
CEV172A6 65
CEV172A7 65
CEV172B6 65
CEV172B7 65
CEV177-5 67
CEV177-12 67

CEV177A3 61,75
CEV177A5 63
CEV177A10 64
CEV177A12 65
CEV178-5 67
CEV179A5 61,63,75
CEV179A10 64
CEV179A12 65
CEV181 68
CEV181-1 68
CEV181A 68
CEV203 74
CEV204 55
CEV204G45 55
CEV205 55
CEV207 55
CEV211U 15
CEV212 66
CEV220U 13
CEV225 53
CEV225A 53
CEV229-1A 53
CEV229-2A 53
CEV229-3A 53
CEV229-4A 53
CEV229B 53
CEV230-1 52
CEV278-10 67
CEV278-12 67
CEV310 39
CEV321 15
CEV326L 62,76
CEV326M 62,76
CEV326P 62,76
CEV326V 62,76
CEV342 74
CEV342E 74
CEV350 74
CEV390B 74
CEV390C 74
CEV391BU 72
CEV391IU 71
CEV392D20 70
CEV392D30 70
CEV392G24 70
CEV392P20 70
CEV392R15 70
CEV392S20 70
CEV393IU 71
CEV394BU 72
CEV394IU 71
CEV395BU 72
CEV395IU 71
CEV396IU 71
CEV397 73
CEV397BG 73
CEV397C 73
CEV398IU 71
CEV399BU 72
CEV399IU 71
CEV404 29
CEV405BG 3

CEV405U.....	3	CEV512.....	15	CEV622IU.....	39
CEV406IU.....	4	CEV514MU.....	28	CEV623T1U.....	26
CEV406U.....	5	CEV515.....	13	CEV624IU.....	12
CEV407IU.....	4	CEV521.....	11	CEV625CU.....	2
CEV407U.....	5	CEV525.....	3	CEV625DU.....	2
CEV410.....	9	CEV525C.....	3	CEV625EU.....	6
CEV413.....	55	CEV526.....	30	CEV625P1U.....	2
CEV416.....	55	CEV527.....	30	CEV625PU.....	6
CEV417.....	68	CEV530.....	9	CEV625T1U.....	2
CEV418.....	68	CEV531-2.....	19	CEV626-1.....	30
CEV419.....	68	CEV531T3U.....	19	CEV627I.....	30
CEV420.....	11	CEV532.....	19	CEV628-5N.....	46
CEV421.....	11	CEV532IU.....	18	CEV628-10.....	44
CEV423.....	55	CEV533-2.....	9	CEV628P5.....	41
CEV425.....	55	CEV535.....	33	CEV630-1A.....	51
CEV430.....	21	CEV538-10.....	24	CEV630C.....	51
CEV431-65.....	35	CEV538T5.....	23	CEV632-1A.....	49
CEV432.....	9	CEV538TU.....	22	CEV633-1A.....	51
CEV433.....	9	CEV540-5.....	23	CEV634-1A.....	49
CEV433-1.....	8	CEV540-10.....	24	CEV635-1.....	32
CEV433DU.....	6	CEV544.....	23	CEV636-1A.....	49
CEV433H.....	8	CEV544IU.....	22	CEV637I.....	49
CEV435-1.....	33	CEV560.....	38	CEV638T5NU.....	46
CEV435-2.....	33	CEV560-1.....	38	CEV640-10.....	24
CEV438.....	59	CEV565.....	38	CEV641DU.....	17
CEV438B.....	59	CEV566.....	38	CEV641FU.....	17
CEV438D5.....	59	CEV567.....	38	CEV641T1U.....	18
CEV440.....	60	CEV568.....	38	CEV642T1U.....	18
CEV440P6.....	60	CEV570.....	31	CEV642TFU.....	17
CEV442.....	25	CEV580-2.....	50	CEV643IU.....	17
CEV442E.....	25	CEV580-3.....	52	CEV646B5U.....	43,48
CEV442Z.....	25	CEV601-1.....	20	CEV647B5U.....	43,48
CEV443.....	54	CEV601P.....	20	CEV648B5U.....	43,48
CEV444.....	69	CEV602-1.....	10	CEV649-10B.....	45
CEV445-5.....	25	CEV603I.....	39	CEV649B5U.....	43,48
CEV445IU.....	25	CEV604T1U.....	26	CEV649BGPU.....	27
CEV448.....	60	CEV604T3U.....	26	CEV649C5U.....	27,43,48
CEV449.....	60	CEV605BGPU.....	27	CEV649G5.....	7
CEV449G.....	60	CEV605GPU.....	27	CEV649GPU.....	27
CEV453.....	55	CEV605GTU.....	26	CEV649M5.....	7
CEV453A.....	55	CEV605GU.....	26	CEV649P5.....	47
CEV455.....	60	CEV605T1U.....	26	CEV649T5BU.....	43,48
CEV456.....	59	CEV605T3U.....	26	CEV649T5NU.....	46
CEV460U.....	5	CEV605T5U.....	26	CEV649X5.....	45
CEV470T1U.....	5	CEV606-1.....	14	CEV650T5D.....	23
CEV470U.....	3	CEV607CU.....	27	CEV650TU.....	22
CEV480.....	64	CEV607DU.....	27	CEV651-1.....	20
CEV500-A10.....	24	CEV607T1U.....	27	CEV652I.....	20
CEV500T5.....	23	CEV607U.....	27	CEV653-1.....	29
CEV500TU.....	22	CEV608-1.....	34	CEV658-10.....	44
CEV501.....	21	CEV608D.....	34	CEV660T1U.....	4
CEV501-2.....	21	CEV610-1.....	8	CEV661IU.....	4
CEV502.....	11	CEV611T1U.....	14	CEV662IU.....	4
CEV503.....	29	CEV612DU.....	16	CEV669B.....	49,51
CEV504PS.....	85	CEV612T1U.....	14	CEV669BG.....	49,51
CEV504S3.....	85	CEV613T1U.....	14	CEV670DU.....	6
CEV504S5.....	85	CEV614T1U.....	12	CEV670T1U.....	2
CEV505.....	33	CEV615T1U.....	12	CEV671T1U.....	4
CEV506.....	15	CEV616IU.....	16	CEV700T5.....	23
CEV507.....	9	CEV617IU.....	12	CEV700T5D.....	23
CEV508.....	35	CEV620T1U.....	12	CEV720.....	47
CEV511.....	15	CEV621T1U.....	10	CEV720B.....	47

CEV720BRUC.....	42	CEV1059-10B.....	44	CEV8649BGPU.....	27
CEV720RU.....	42	CEV2295A.....	53	CEV8649C5U.....	27,43,48
CEV721.....	11	CEV6285R.....	41	CEV8649GPU.....	27
CEV725.....	3	CEV6385RU.....	41	CEV8649P5.....	47
CEV728BR.....	44	CEV6795B.....	49,51	CEV8649T5NU.....	46
CEV728BR5U.....	42	CEV7145A3.....	63	CEV8649T5TBU.....	43,48
CEV728T5.....	41	CEV7145A5.....	63	CEV8649X5.....	45
CEV728T10.....	44	CEV7145A6.....	63	CEV8650TU.....	22
CEV738-5.....	23	CEV7145A7.....	63	CEV8660T1U.....	4
CEV738D5.....	23	CEV7145B6.....	63	CEV8670DU.....	6
CEV738T5.....	23	CEV7145B7.....	63	CEV8826L.....	62,76
CEV740-5.....	23	CEV7285RU.....	42	CEV8826M.....	62,76
CEV744T5.....	23	CEV7625I.....	7	CEV8826P.....	62,76
CEV760.....	5	CEV7660I.....	7	CEV8826V.....	62,76
CEV804.....	28	CEV8103D5.....	58	CEV9103D5.....	58
CEV805I.....	66	CEV8103G3.....	77	CEV9103G5.....	58
CEV815.....	3	CEV8103G5.....	58	CEV9104IU.....	26
CEV821G.....	11	CEV8104IU.....	26	CEV9107IU.....	69
CEV825.....	53	CEV8107IU.....	69	CEV9134BG.....	50
CEV830.....	52	CEV8126P.....	63	CEV9145A3.....	63
CEV834.....	50	CEV8126PM.....	63	CEV9145A5.....	63
CEV890.....	77	CEV8126V.....	63	CEV9145A6.....	63
CEV890C.....	77	CEV8143A3.....	61,75	CEV9145A7.....	63
CEV891IU.....	79	CEV8143A4.....	61,75	CEV9145B6.....	63
CEV891MU.....	80	CEV8143A7.....	61,75	CEV9145B7.....	63
CEV892.....	81	CEV8143B7.....	61,75	CEV9150A3.....	64
CEV893IU.....	79	CEV8145A3.....	63	CEV9150A4.....	64
CEV894IU.....	79	CEV8145A5.....	63	CEV9150A6.....	64
CEV894MU.....	80	CEV8145A6.....	63	CEV9150A7.....	64
CEV895IU.....	79	CEV8145A7.....	63	CEV9150B6.....	64
CEV895MU.....	80	CEV8145B6.....	63	CEV9150B7.....	64
CEV896.....	77	CEV8145B7.....	63	CEV9172A3.....	65
CEV896IU.....	79	CEV8407IU.....	4	CEV9172A4.....	65
CEV897.....	78	CEV8434I.....	8	CEV9172A6.....	65
CEV897BG.....	78	CEV8445IU.....	25	CEV9172A7.....	65
CEV897C.....	78	CEV8538TU.....	22	CEV9172B6.....	65
CEV898.....	77	CEV8544IU.....	22	CEV9172B7.....	65
CEV898IU.....	79	CEV8604T1U.....	26	CEV9229-1.....	53
CEV898L.....	77	CEV8605GTU.....	26	CEV9407IU.....	4
CEV899IU.....	79	CEV8605GU.....	26	CEV9445IU.....	25
CEV899U.....	80	CEV8605T1U.....	26	CEV9500TU.....	22
CEV904.....	28	CEV8607T1U.....	27	CEV9544IU.....	22
CEV915G.....	3	CEV8611T1U.....	14	CEV9604T1U.....	26
CEV965.....	23	CEV8612DU.....	16	CEV9605GTU.....	26
CEV980-3.....	56	CEV8613T1U.....	14	CEV9605GU.....	26
CEV980A.....	56	CEV8615T1U.....	12	CEV9605T1U.....	26
CEV980B.....	56	CEV8616IU.....	16	CEV9607T1U.....	27
CEV984.....	56	CEV8621T1U.....	10	CEV9611T1U.....	14
CEV985.....	56	CEV8623T1U.....	26	CEV9612DU.....	16
CEV992.....	81	CEV8624IU.....	12	CEV9614T1U.....	12
CEV992B.....	72	CEV8625CU.....	2	CEV9615T1U.....	12
CEV992C.....	72	CEV8625DU.....	2	CEV9617IU.....	12
CEV992D.....	81	CEV8625EU.....	6	CEV9620T1U.....	12
CEV995MU.....	81	CEV8625T1U.....	2	CEV9623T1U.....	26
CEV996MU.....	81	CEV8626I.....	30	CEV9624IU.....	12
CEV997MU.....	81	CEV8627I.....	30	CEV9625CU.....	2
CEV998MU.....	81	CEV8641T1U.....	18	CEV9625DU.....	2
CEV1019T5BU.....	40	CEV8642T1U.....	18	CEV9625T1U.....	2
CEV1019T5NUC.....	46	CEV8646B5U.....	43,48	CEV9627I.....	30
CEV1039G5U.....	40	CEV8647B5U.....	43,48	CEV9630-1A.....	51
CEV1039T5NU.....	46	CEV8648B5U.....	43,48	CEV9634-1A.....	49
CEV1039T5TBU.....	40	CEV8649B5U.....	43,48	CEV9641T1U.....	18

CEV9642T1U.....	18
CEV9646B5U.....	43,48
CEV9647B5U.....	43,48
CEV9648B5U.....	43,48
CEV9649B5U.....	43,48
CEV9649BGPU.....	27
CEV9649C5U.....	27,43,48
CEV9649GPU.....	27
CEV9649P5.....	47
CEV9649T5NU.....	46
CEV9649T5TBU.....	43,48
CEV9649X5.....	45
CEV9650TU.....	22
CEV9660T1U.....	4
CEV9670DU.....	6
CEV9700T5D.....	23
CEV9738T5.....	23
CEV9744T5.....	23
CEV10195CU.....	40
CEV10195DU.....	40
CEV10195NAU.....	46
CEV10195RU.....	40
CEV10395DU.....	40
CEV10395RU.....	40
CEV72810R.....	44
CEV82291.....	53
CEV86341A.....	49
CEV86361A.....	49
CEV86795B.....	49
CEV96321A.....	49
CEV96331A.....	51
CEV96361A.....	49
CEV96795B.....	49,51
CEV102910R.....	44
CEV864910B.....	45

CEVA

CEVA101.....	36
CEVA102.....	36
CEVA103.....	36
CEVA104.....	36
CEVA110.....	37
CEVA112.....	33
CEVA528.....	37
CEVA529.....	37

CM

CM104.....	28
CM106.....	28
CM107U.....	69
CM109.....	54
CM110U.....	13
CM111U.....	15
CM112U.....	15
CM113U.....	15
CM115U.....	13
CM120U.....	13
CM131.....	52

CM170-1.....	59
CM170-2.....	59
CM170-3.....	59
CM217S ^(D)	57
CM20128H-5.....	57
CM20128H-10.....	57
CM20132H-5.....	57
CM20132H10.....	57
CM20132L-5.....	57
CM20140H5.....	57

CP

CP391E.....	54
CP391M.....	54
CP391V.....	54
CP393-2.....	48,70
CP393-3.....	48,70
CP393-4.....	48,70

MCEN

MCEN54P.....	49,51
--------------	-------

MCLP

MCLP10.....	83
MCLP20U.....	83
MCLP25U.....	83
MCLP30U.....	83
MCLP40U.....	83
MCLP50.....	83
MCLP60.....	83
MCLP70.....	83

MCLT

MCLT10.....	84
MCLT11.....	84
MCLT20.....	84
MCLT21.....	84
MCLT30.....	84
MCLT40.....	84
MCLT50.....	84

S

SM63 ^(D)	54
SM64 ^(D)	54
SM65 ^(D)	54

^(D) Distribué par Integra MicroFrance SAS (France) - Voir tableau d'équivalence annexe pour la référence du fabricant correspondante

Integra MicroFrance® référence produit	Référence fabricant équivalente
CM217S	CM217S
SM63	SM63
SM64	SM64
SM65	SM65



Integra MicroFrance SAS (France)
Le Pavillon ■ 03160 Saint Aubin le Monial ■ France



HEMODIA SAS
85, rue du Chêne Vert
31670 LABEGE ■ France



Swann Morton Ltd
Penn Works ■ Owlerton Green ■ Sheffield
South Yorkshire S6 2BJ ■ Royaume Uni



Emergo Europe
Prinsessegracht 20
2514 AP ■ The Hague ■ Pays-Bas

Informations supplémentaires pour les clients Europe, Moyen-Orient, Afrique :

Attention : la loi restreint la vente de ces appareils à des médecins ou suite à leur prescription.

Tous les dispositifs médicaux mentionnés dans ce document sont marqués CE conformément aux lois européennes applicables, sauf mention spécifique "PAS DE MARQUAGE CE".

Les produits mentionnés dans ce document ne sont pas inscrits à la Liste des Produits et Prestations Remboursables (LPPR) mentionnée à l'article L165-1 du code de la sécurité sociale et ne sont pas éligibles au remboursement par l'Assurance Maladie.

Tous les textes et diagrammes contenus dans ce catalogue sont à considérer comme des notes d'orientations et sont à but illustratif seulement. Aucune information contenue dans ce catalogue n'a pour but de se substituer au mode d'emploi présent dans chaque emballage des produits Integra. Veuillez toujours vous référer au mode d'emploi approprié pour les instructions cliniques complètes. Pour des informations supplémentaires techniques et cliniques sur les produits Integra, veuillez contacter votre spécialiste Integra.

Lire attentivement la notice d'instructions du produit.

La disponibilité de ces produits peut varier d'un pays ou d'une région à l'autre du fait de procédures d'enregistrement réglementaires ou de conditions de vente locales spécifiques.

Les produits identifiés par le symbole ^(Q) sont distribués par Integra MicroFrance SAS (France).

Produits de classe I, IIa, IIb. Pour plus d'informations sur la classe des produits, veuillez contacter le Service Client Integra.

Consultez les étiquettes et les notices des produits pour connaître les indications, les contre-indications, les dangers, les avertissements et les précautions à prendre.

Date de dernière révision: 04/2023

Pour plus d'informations, veuillez contacter le service client :

Europe, Moyen-Orient, Afrique

International : +33 (0) 4 37 47 59 50 ■ +33 (0) 4 37 47 59 25 (Fax) ■ csema@integralife.com
France : +33 (0) 4 37 47 59 10 ■ +33 (0) 4 37 47 59 29 (Fax) ■ custservfrance@integralife.com
Belgique & Luxembourg : +32 (0) 2 257 4130 ■ +32 (0) 2 253 2466 (Fax) ■ custsvcbenelux@integralife.com
Royaume-Uni : +44 (0) 1264 312 725 ■ +44 (0) 1264 312 821 (Fax) ■ custsvcs.uk@integralife.com
Pays-Bas : +31 (0) 852 083 167 ■ +31 (0) 207 093 627 (Fax) ■ custsvcnetherlands@integralife.com
Italie : +39 (0) 2 577 8921 ■ +39 (0) 2 575 113 71 (Fax) ■ custsvcityal@integralife.com
integralife.eu/contact

MicroFrance, Integra et le logo Integra sont des marques enregistrées de Integra LifeSciences Corporation ou de ses filiales aux USA et/ou dans d'autres pays. Toutes les autres marques et noms de produits sont la propriété de leurs propriétaires respectifs.

© 2023 Integra LifeSciences Corporation. Tous droits réservés.

0328572-5-FR.

DOCUMENT DESTINE A L'EUROPE, AU MOYEN-ORIENT ET A L'AFRIQUE UNIQUEMENT.