



Integra[®] MicroFrance[®]

Integra Laparoscopy catalogue

Table of contents	ii-iii	Rotatable handles, for \varnothing 5 and 10 mm non-insulated tube	44
Warranty and Customer Service Information	iv	Angled handle	44
Indications - Contraindications	v	Axial handle	44
MicroFrance® modular Instruments	vi-vii	Ergonomic handle	44
Fenestrated forceps \varnothing 5 mm	2-6	Non-insulated tubes	45
Graduated fenestrated forceps \varnothing 5 mm	7	for rotatable instrument \varnothing 5mm	45
Fenestrated forceps \varnothing 10 mm	8-9	for rotatable instrument \varnothing 10mm	45
Babcock forceps	10-11	Non rotatable handles, \varnothing 5 mm and insulated tubes	46
Alligator forceps \varnothing 5 mm	12-13	Angled handle	46
Teeth forceps	14-16	Axial handle	46
Dissector \varnothing 5 mm	17-19	Black insulated tube for non-rotatable instrument	46
Dissector \varnothing 10 mm	20-21	Non rotatable ergonomic handles and non insulated tubes	47
Needle-Holder 5 mm	22-23	Bipolar cables	48
Needle-Holder 10 mm	24	Non rotatable bipolar forceps, \varnothing 5 mm	49-52
Knot Pusher, Knot guide scissors	25	Monopolar hook	53
Scissors \varnothing 5 mm	26-28	Retractable knives, Palpation probe	54
Black sheath for metal tube	27	Knife blade	54
Complete non modular instruments	28	Monopolar cable	54
Insulated scissors insert	27	Monopolar palpation probe	54
Metal tube	27	Retractable knife	54
Modular instrument	26	Retractable monopolar electrode	54
Wire insert	27	Retractors - Palpation probes	55
Scissors \varnothing 10 mm	29	Articulated retractor	55
Vascular clamp \varnothing 5 mm	30	Flat palpation probe	55
Vascular clamp \varnothing 12 mm	31	Flexible retractor	55
Vascular clamp \varnothing 10 mm	32-33	Round palpation probe	55
Intestinal clamp	34-35	Flexible tension arm	56
Aortic percutaneous clamp	36-37	Instrument holder	56
Temporary Clamp, Clamp applicator	38	Operating table clamp	56
Clips applier, Circular suturing holder insert	39	Electric irrigation suction pump	57
Rotatable angled handles, \varnothing 5 or 3.5 mm	40	Cleaning sleeve for telescope	57
Rotatable axial handles, \varnothing 5 or 3.5mm	41	Suction irrigation tubes for handle	57
Rotatable ergonomic handles, \varnothing 5 or 3.5 mm	42	Suction irrigation tube	58
Tubes, \varnothing 5 mm for rotatable handles, \varnothing 5 or 3.5 mm	43	Handle for modular suction irrigation tube	58
Insulated tube	43	Modular suction irrigation tube	58
Metal tube and pack of 3 black sheaths	43	Non modular suction irrigation tube	58
		Needles - Wire-pass	59
		Cholangiography - Cholescopy	60

Modular trocars - 3.5 mm	61-62	Mini invasive instrumentation, 5mm diameter, stylet handle	82
Trocar with metal cannula with magnetic valve	62	Curved scissors, titanium jaws	82
Trocar with metal cannula with silicone valve	62	Forceps with teeth	82
Modular trocars - 5.5 mm	63	Needle-holder, titanium jaws	82
Modular trocars - 10.5 mm	64	Needle-holder, tungsten jaws	82
Modular trocar 10,5mm	64	Henry set - 3.0mm diameter	83
Trocar tip palpator probe	64	Fenestrated forceps	83
Modular trocars - 12/13 mm	65	Forceps, alligator jaws	83
Trumpet valve trocars	66	Monopolar hook	83
Spring for Trumpet valve trocars	66	Round probe	83
Trumpet valve trocars	66	Scissors	83
Automatic valve trocars	67	Trocar	83
Trocar accessories	68	Trocar holder ring	83
Double retractor	68	Terris set	84
Reducer sleeve for trocar	68	Double retractor	84
Sealing cap for trocar	68	Elevator	84
Thoracic Instrumentation	69	Nerve suction with finger control	84
Fenestrated forceps	69	Peanut holder	84
Forceps, curette jaws	69	Suction tube elevator	84
Insert, curette jaws	69	Scheye rectal forceps	85
Trocar	69	Axial handle	85
Irrigation bipolar forceps	70	Insert, biopsy jaws and tube 5mm diam	85
3.5mm diameter instrumentation	71-75	Sterilization case, other accessories	86
Adapter cleaning luer-lock	72	Cap	86
Bipolar forceps	74	Stainless steel sterilization case	86
Complete non modular instrument	73	Tray	86
Forceps without port	75	Numerical index	87-91
Knot pusher	75	Table for manufacturer part number equivalent	92
Modular instrument	72		
Monopolar hook	75		
Palpation probe	75		
Suction irrigation tube	75		
Pediatric instrumentation, 3.5mm diameter	76-81		
Adapter cleaning luer-lock	80		
Bipolar forceps	79		
Complete non modular instrument	81		
Composite trocar	77		
De Lagausie monopolar instrument	81		
Metallic trocar	76		
Modular instrument	80		
Monopolar hook	78		
Needle-holder	81		
Retractable knife	78		
Suction irrigation tube	78		

Integra Limited Warranty

Please refer to the warranty included in the packaging of each product to know the applicable warranty.

Contacts Customer service:

International

+33 (0) 4 37 47 59 50
+33 (0) 4 37 47 59 25 (fax)
csemea@integralife.com

France

+33 (0) 4 37 47 59 10
+33 (0) 4 37 47 59 29 (Fax)
custservfrance@integralife.com

Belgium & Luxembourg

+32 (0) 2 257 4130
+32 (0) 2 253 2466 (Fax)
custsvcbenelux@integralife.com

United Kingdom

+44 (0) 1264 312 725
+44 (0) 1264 312 821 (Fax)
custsvcs.uk@integralife.com

Netherlands

+31 (0) 852 083 167
+31 (0) 207 093 627 (Fax)
custsvcnetherlands@integralife.com

Italy

+39 (0) 2 577 8921
+39 (0) 2 575 113 71 (Fax)
custsvcitaly@integralife.com

MicroFrance® Laparoscopy Instrumentation

INDICATIONS

- All the medical devices showed in this catalogue have indications for diagnosis and/or laparoscopy surgery.
- Sizes are not contractual and are given for information purposes only.

CONTRAINDICATIONS

- Do not use in indications other than the indications mentioned in the DFU or Labeling.

How to read this catalogue

Title and/or product family Symbole
"Complete instrument"

"Modular" symbol

Instrument to a 1/1 scale except where mentioned otherwise

Fenestrated forceps # 5 mm				
Modular			Handle Page #	
Jaws Scale (x)	Working length			
	Short	Standard	Large	
Johann 200mm	CEV8625CU 345 mm	CEV8625CU 345 mm	CEV8625CU 345 mm	Rotatable 40 -> 45
Concave 200mm		CEV8625CU 345 mm		
Bertrand Curved jaws 200mm	Bertrand CEV8625CU 345 mm	Bertrand CEV8625CU 345 mm	Bertrand CEV8625CU 345 mm	Non rotatable 46 - 47
Johann 200mm		CEV8625CU 345 mm "Sintermetal" design		
Double-action jaws 200mm	CEV8625DU 345 mm	CEV8625DU 345 mm	CEV8625DU 345 mm	

Fenestrated forceps # 5 mm			
NON Modular Complete instruments			
Jaws Scale (x)	Handle	Working length	
		Short	Standard
Johann 200mm	Monopolar with ratchet	Johann CEV8650 345 mm	
	With spring	Gayet CEV8638C 345 mm	
	A coimelline	Montipout CEV8616 240 mm	
	A coimelline	CEV8615C 240 mm	CEV8615 345 mm
	With long ratchet		CEV8619 345 mm
Concave 200mm	Monopolar with ratchet		CEV8620 345 mm
Curved jaws 200mm	A coimelline		Bertrand CEV8638C 345 mm

DOCUMENT FOR USE IN EUROPE, MIDDLE-EAST AND AFRICA ONLY.

Except contrary indications, pages of this catalogue are presented as below :

- left page : modular instruments
- right page : complete non modular instrument

In the majority of cases, modular instruments are linked to complete instruments. If we don't have any correspondence, you will have an «X» on the line.

Example : CEV8625CU doesn't have complete version.

In the modular inserts table, handles to be used are precised with specific pages. Tubing compatible with handles are mentioned on pages close to handles' pages.

Please refer to modular instruments composition on following page.

MicroFrance® laparoscopic dismantled instruments are composed of three pieces : Jaws, tube and handle..

The black portion of the left tab indicates the section featured in the current page :



In the majority of cases, modular instruments are linked to complete instruments

Handles

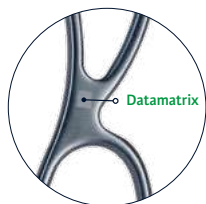
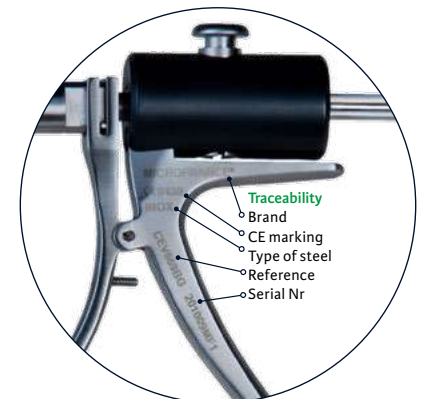
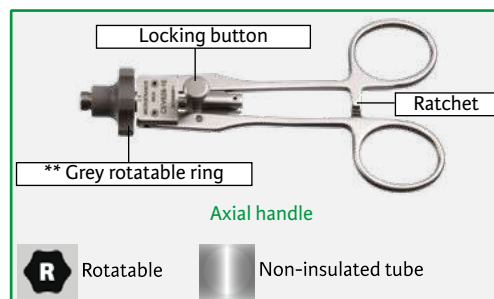
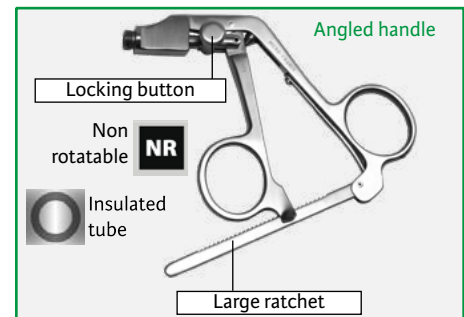
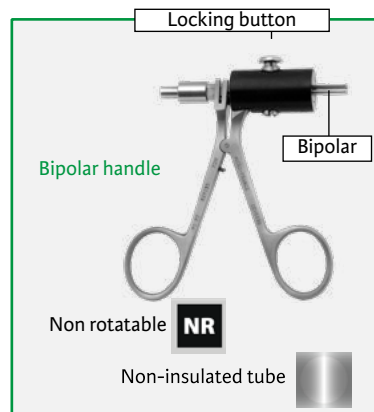
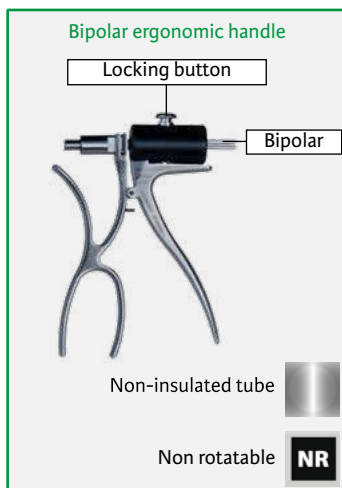
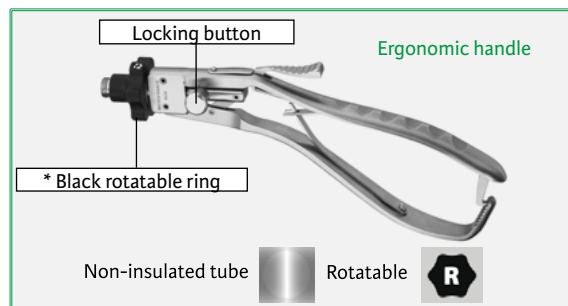

**** Grey rotatable ring for metal tube or non insulated tube ø 5mm and 10mm**





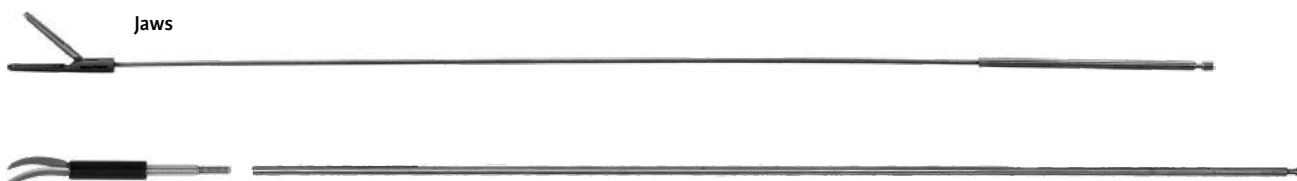









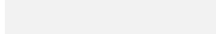

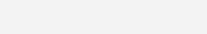
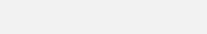
*** Black rotatable ring for ø 5mm insulated tube**

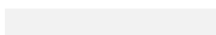
Jaws 

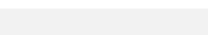

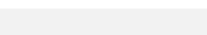
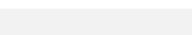

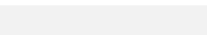

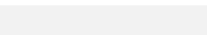
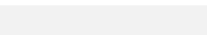
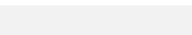
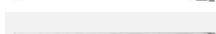
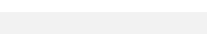
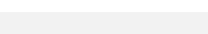
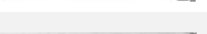
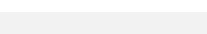
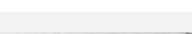



Modular scissors insert : insulated scissors insert blades and wire insert for scissors insert

Tubes 

Non rotatable instrument	Rotatable instrument	Insulated tube	Non insulated tube	Tube with independant sheath	Used for bipolar instrument
					
					
					
					
					

















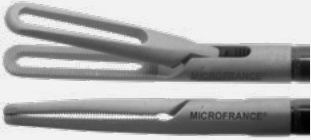







Modular				
Inserts				Handle
Jaws Scale 1/1	Working length			Page #
	Short	Standard	Large	
 Johann 20x5mm	CEV8625T1U 245 mm	CEV625T1U 345 mm	CEV9625T1U 445 mm	 Rotatable 40 -> 45
 Concave 20x5mm	—	CEV670T1U 345 mm	—	Non rotatable 46 - 47
 Curved jaws 20x5mm	Bertrand CEV8625CU 245 mm	Bertrand CEV625CU 345 mm	Bertrand CEV9625CU 445 mm	
 Johann 20x5mm	—	CEV625P1U 345 mm "Switzerland" design	—	
 Double-action jaws 20x5mm	CEV8625DU 245 mm	CEV625DU 345 mm	CEV9625DU 445 mm	

NON Modular

Complete instruments

















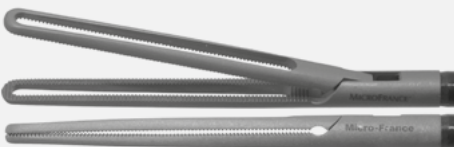

Jaws Scale 1/1	Handle	Working length	
		Short	Standard
 Johann 20x5mm	 With ratchet		Johann CEV405U 365 mm
	 With spring	-	Gayet CEV405BG 365 mm
	 With ratchet		Montupet CEV815 240 mm
	 With ratchet	CEV915G 240 mm	CEV525 345 mm
	 With long ratchet	-	CEV725 345 mm
 Concave 20x5mm	 With ratchet	-	CEV470U 365 mm
 Curved jaws 20x5mm	 With ratchet	-	Bertrand CEV525C 345 mm





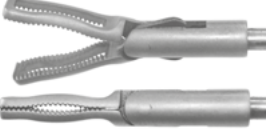

	Modular				
	Inserts			Handle	
	Jaws Scale 1/1	Working length			
	Short	Standard	Large		
 15x5mm	-	CEV4o6IU 340 mm	-		
 Desmaizieres 20x3mm	CEV84o7IU 245 mm	CEV4o7IU 345 mm	CEV94o7IU 445mm	  	
 40x5mm	CEV866oT1U 270 mm	CEV66oT1U 370 mm	CEV966oT1U 470 mm	Rotatable 40 -> 45	
 Concave 40x5mm	-	CEV671T1U 370 mm	-	Non rotatable 46 - 47	
 Crovella 40x5mm smooth jaws	-	CEV661IU 370 mm	-	 	
 Crovella 30x5mm smooth jaws	-	CEV662IU 335mm	-		

NON Modular

Complete instruments



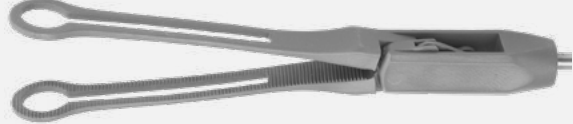







Jaws Scale 1/1	Handle	Working length	
		Standard	
 15x5mm	 With ratchet	CEV406U	360mm
 Desmaizieres 20x3mm	 With ratchet	Desmaizieres CEV407U	365mm
 40x5mm	 With ratchet	Desplantez CEV460U	385mm
	 Axial, with long ratchet	CEV760	365mm
 Concave 40x5mm	 With ratchet	CEV470T1U	385mm







	Modular				Page #	
	Inserts			Working length		Page #
	Jaws Scale 1/1	Short	Standard			
 Round double-action jaws 15x5mm	-	CEV433DU 350 mm	-	   Rotatable 40 -> 45 Non rotatable 46 - 47  		
 Smooth jaws 20x5mm	CEV8625EU 245 mm	CEV625EU 345 mm	-			
 Porpiglia one fenestrated jaws 20x5mm	-	CEV625PU 345 mm	-			
 Concave double-action jaws 15x5mm	CEV8670DU 240 mm	CEV670DU 340 mm	CEV9670DU 440 mm			

Modular		
Inserts		Handle
Jaws Scale 1/1	Working length	Page #
 Round jaws, Double-action jaws	CEV433-1 370 mm	 Rotatable 44 -> 45 
 35x10mm	CEV610-1 375 mm	
 Hüscher Round jaws, Double-action jaws	CEV433H 380 mm	
 Round jaws, Double-action jaws with tube CEV864910B (see page 45)	CEV8434I 295 mm Short	

NON Modular

Complete instruments







	NON Modular		
	Complete instruments		
Jaws Scale 1/1	Handle	Working length	
 <p>Round jaws, Double-action jaws</p>	 <p>Axial, with ratchet</p>	<p>CEV533-2 370 mm</p>	
 <p>35x10mm</p>	 <p>Angled, with long ratchet</p>	<p>CEV410 360 mm</p>	
	 <p>Axial, with ratchet</p>	<p>CEV530 370 mm</p>	
 <p>Duval</p>	 <p>Angled, with long ratchet</p>	<p>CEV432 365 mm</p>	
	 <p>Axial, with ratchet</p>	<p>CEV507 375 mm</p>	
 <p>Round jaws</p>	 <p>Angled, with long ratchet</p>	<p>CEV433 365 mm</p>	











Modular		
Inserts		Handle
Jaws Scale 1/1	Working length	
		Page #
 Ø10mm	Delaitre CEV602-1 370 mm	
		 Rotatable 44 - 45 
		 Rotatable 40 -> 45 Non rotatable 46 - 47 
 Delaitre Ø5mm	Short Standard CEV8621T1U 250 mm CEV621T1U 350 mm	

NON Modular

Complete instruments





















Jaws Scale 1/1	Handle	Working length				
 Ø10mm	 Angled, with long ratchet	Delaitre CEV420 360 mm				
	 Axial with ratchet	Delaitre CEV502 370 mm				
 Ø5mm	 Angled, with long ratchet	<table border="0"> <tr> <td>Short</td> <td>Standard</td> </tr> <tr> <td> Montupet CEV821G 245 mm </td> <td> Delaitre CEV421 370 mm </td> </tr> </table>	Short	Standard	Montupet CEV821G 245 mm	Delaitre CEV421 370 mm
	Short	Standard				
	Montupet CEV821G 245 mm	Delaitre CEV421 370 mm				
 Axial, with ratchet	– Delaitre CEV521 350 mm					
 Axial with long ratchet	– CEV721 350 mm					

Modular				
Inserts			Handle	
Jaws Scale 1/1	Working length			Page #
	Short	Standard	Large	
 Manhès 10mm	-	CEV614T1U 335 mm	CEV9614T1U 435 mm	   Rotatable 40 -> 45 Non rotatable 46 - 47  
 Manhès 15mm	CEV8615T1U 240 mm	CEV615T1U 340 mm	CEV9615T1U 440 mm	
 Manhès 20mm	-	CEV620T1U 345 mm	CEV9620T1U 445 mm	
 Dauphin 20x3mm	-	CEV617IU 340 mm	CEV9617IU 440 mm	
 Serrated jaws inserts, 15x5mm	CEV8624IU 240 mm	CEV624IU 340 mm	CEV9624IU 440 mm	

NON Modular













Complete instruments







Jaws Scale 1/1	Handle	Working length	
		Standard	
 10mm	 With ratchet	Manhès CM110U 355 mm	
 15mm	 With ratchet	Manhès CM115U 360 mm	
	 Axial, with ratchet	CEV515 340 mm	
 20mm	 With spring	Manhès CEV220U 365 mm	
	 With ratchet	Manhès CM120U 365 mm	

		Modular				
		Inserts			Handle	
Jaws Scale 1/1		Working length			Page #	
 Ø10mm Grasping insert		Claw CEV606-1 370 mm			 Rotatable 44 -> 45 	
		Short	Standard	Large		
 Allis Grasping insert Ø5mm		CEV8611T1U 235 mm	Allis CEV611T1U 335 mm	Allis CEV9611T1U 435 mm	   Rotatable 40 -> 45	
 Manhès Cobra Ø5mm		-	Manhès CEV612T1U 340 mm	-	Non rotatable 46 - 47 	
 Manhès Tiger Ø5mm		CEV8613T1U 240 mm	Manhès CEV613T1U 340 mm	-		

NON Modular









Complete instruments









Jaws Scale 1/1	Handle	Working length
		Standard
 Ø10mm	 Angled with spring	Claw CEV321 360 mm
	 Axial, with ratchet	Claw CEV506 370 mm
 Allis Grasping forceps Ø5mm	 With spring	Allis CEV211U 355 mm
	 With ratchet	Allis CM111U 355 mm
	 Axial, with ratchet	Allis CEV511 335 mm
 Manhès Cobra Ø5mm	 With ratchet	Manhès CM112U 355 mm
	 Axial, with ratchet	Manhès CEV512 335 mm
 Manhès Tiger Ø5mm	 With ratchet	Manhès CM113U 360 mm

Modular				
Inserts			Handle	
Jaws Scale 1/1	Working length			Page #
	Short	Standard	Large	
 cobra Double-action jaws Ø5mm	CEV8612DU 240 mm	CEV612DU 340 mm	CEV9612DU 440 mm	   Rotatable 40 -> 45
 Vallancien Fenestrated jaws insert with teeth Ø5mm 20x5mm	CEV8616IU 245 mm	CEV616IU 345 mm	-	Non rotatable 46 - 47  









Modular







Inserts		Handle
Jaws Scale 1/1	Working length	Page #
 <p>Delaitre Double-action jaws, 22mm ø5mm</p>	<p>CEV641DU 355 mm</p>	  <p>Rotatable 40 -> 45</p> <p>Non rotatable 46 - 47</p>  
 <p>Double-action jaws, 20mm ø5mm</p>	<p>CEV641FU 350 mm</p>	
 <p>Allal Double-action jaws 15mm ø5mm</p>	<p>CEV642TFU 345 mm</p>	
 <p>Double-action jaws, angled 20mm jaws 90deg ø 5mm</p>	<p>CEV643IU 345 mm</p>	

	Modular			
	Inserts			Handle
	Jaws Scale 1/1	Working length		
	Short	Standard	Large	
 Short curved Double-action jaws, 12mm	-	CEV532IU 335 mm	-	  Rotatable 40 -> 45 Non rotatable 46 - 47
 Medium curved Double-action jaws, 15mm	CEV8641T1U 245 mm	CEV641T1U 345 mm	CEV9641T1U 445 mm	
 Long curved Double-action jaws, 18mm	CEV8642T1U 245 mm	CEV642T1U 345 mm	CEV9642T1U 445 mm	 

NON Modular

Complete instruments







Jaws Scale 1/1	Handle	Working length
 <p>Short curved Double-action jaws, 12mm</p>	 <p>Axial, with ratchet</p>	<p>CEV532 340 mm</p>
 <p>Medium curved Double-action jaws, 15mm</p>	 <p>Axial, with ratchet</p>	<p>CEV531-2 340 mm</p>
 <p>Long curved Double-action jaws, 18mm</p>	 <p>Axial, with ratchet</p>	<p>CEV531T3U 350 mm</p>











	Modular		
	Inserts		Handle
	Jaws Scale 1/1	Working length	Page #
 Delaitre Medium curved 50mm	CEV601-1 380 mm		
 Delaitre Medium curved - Double-action jaws, 50mm	CEV651-1 380 mm	 	
 Pignata Short curved 90deg, 45mm	CEV601P 380 mm	Rotatable 44 -> 45	
 Puglisi Long curved Double-action jaws, 60mm	CEV652I 380 mm		

NON Modular

Complete instruments

























Jaws Scale 1/1	Handle	Working length
 <p>Medium curved 50mm</p>	 <p>Angled</p>	<p>Delaitre CEV430 370 mm</p>
 <p>Medium curved - Double-action jaws, 50mm</p>	 <p>Axial, with ratchet</p>	<p>Nouaille CEV501 380 mm</p>
 <p>Delaitre Medium curved - Double-action jaws, 50mm</p>	 <p>Axial, with ratchet</p>	<p>CEV501-2 380 mm</p>

	Modular			
	Inserts			Handle
	Jaws Scale 1/1	Working length		
	Short	Standard	Large	
 Tungsten straight jaws	-	CEV500TU 335 mm	CEV9500TU 435 mm	   Rotatable 40 -> 45 Non rotatable 46 - 47  
 Tungsten curved left jaws	CEV8538TU 240 mm	CEV538TU 340 mm	-	
 Tungsten curved right jaws	CEV8544IU 240 mm	CEV544IU 340 mm	CEV9544IU 440 mm	
 Titanium automatic jaws	CEV8650TU 235 mm	CEV650TU 335 mm	CEV9650TU 435 mm	

NON Modular

Complete instruments

Jaws Scale 1/1	Handle	Working length		
		Short	Standard	Large
 Tungsten straight jaws	 Axial, with ratchet	CEV965 230 mm	CEV500T5 335 mm	–
	 Large ergonomic handle with ratchet up	–	CEV700T5 335 mm	–
	 Large ergonomic handle with ratchet up	–	CEV700T5D 335 mm	CEV9700T5D 450 mm
 Tungsten curved left jaws	 Axial, with ratchet	–	CEV538T5 335 mm	–
	 Large ergonomic handle with ratchet up	–	CEV738T5 335 mm	CEV9738T5 455 mm
	 Fine ergonomic handle	–	CEV738-5 350 mm	–
	 Fine ergonomic handle	–	CEV738D5 350 mm	–
 Tungsten curved right jaws	 Axial, with ratchet	–	CEV544 335 mm	–
	 Large ergonomic handle with ratchet up	–	CEV744T5 335 mm	CEV9744T5 455 mm
 Titanium automatic jaws	 Axial, with ratchet	–	Mouiel CEV540-5 335 mm	–
	 Large ergonomic handle with ratchet up	–	CEV650T5D 335 mm	–
	 Fine ergonomic handle	–	CEV740-5 350 mm	–

NON Modular			
Complete instruments			
Jaws Scale 1/1	Handle		Working length
 <p>Nouaille Straight jaws</p>	 <p>Axial, with ratchet</p>	<p>Nouaille CEV500-A10 345 mm</p>	
 <p>Left curved jaws</p>	 <p>Axial, with ratchet</p>	<p>CEV538-10 345 mm</p>	
 <p>Straight automatic jaws</p>	 <p>Axial, with ratchet</p>	<p>Mouiel CEV540-10 345 mm</p>	
	 <p>Fine ergonomic handle</p>	<p>CEV640-10 340 mm</p>	



















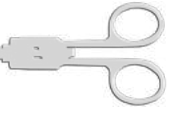









Knot Pusher - 5 mm

		NON Modular	
		Complete instruments	
	<p>Delaitre CEV442 L 340 mm</p>		Working length «L» Scale 1/3
	<p>CEV442E L 300 mm</p>		
	<p>CEV442Z L 350 mm</p>		









Knot guide scissors - 5 mm

		NON Modular		Modular			
		Complete instruments					
Jaws Scale 1/1	Handle	Working length			Short	Standard	Large
<p>Drouard Complete non modular instrument</p>	<p>Angled handle</p>						
<p>Drouard Modular instrument</p>	<p>Rotatable 40 -> 45</p>	<p>Non rotatable 46 - 47</p>			CEV8445IU 235 mm	CEV445IU 335 mm	CEV9445IU 435 mm

Modular				
Inserts				Handle
Blades Scale 1/1	Working length			Page #
	Short	Standard	Large	
 Straight, serrated blades 10mm	CEV8104IU 240 mm	CEV104IU 340 mm	CEV9104IU 440 mm	
 Straight, Double-action jaws, 10mm	CEV8623T1U 240 mm	CEV623T1U 340 mm	CEV9623T1U 440 mm	
 Curved, Double-action jaws, 15mm	CEV8605T1U 245 mm	CEV605T1U 345 mm Pack 1 CEV605T3U 345 mm Pack 3	CEV9605T1U 445 mm	  Rotatable 40 -> 45
 Curved, double-action jaws, 15mm with insulated tube delivered with CEV39L (see page 71)	-	CEV605T5U 345 mm Pack 3	-	Non rotatable 46 - 47
 Curved, insulated, double-action jaws, 15mm	CEV8605GU 250 mm Pack 3	CEV605GU 350 mm Pack 3	CEV9605GU 450 mm Pack 3	 
 Curved, insulated, double-action titanium jaws, 15mm	CEV8605GTU 250 mm	CEV605GTU 350 mm	CEV9605GTU 450 mm	
 Curved, Double-action jaws, 10mm	CEV8604T1U 240 mm	CEV604T1U 340 mm Pack 1 CEV604T3U 340 mm Pack 3	CEV9604T1U 440 mm	



	Modular						
	Insulated insert		Wire insert			Handle	
	Double-action jaws for wire insert Scale 1/1		Working length - Scale 1/6			Page #	
		245 mm	345 mm	445 mm			
 <p>CEV607U Curved, Metzenbaum type, 15 mm - Pack 6</p>		  					
 <p>CEV607CU Curved blades, 10mm - Pack 6</p>							
 <p>CEV607DU Straight blades, 10mm - Pack 6</p>					<p>Rotatable 40 -> 45</p>		
 <p>Curved, Metzenbaum type</p> <p>CEV605BGPU single</p> <p>CEV605GPU Pack 3</p>		  			<p>Non rotatable 46 - 47</p>  		
		Metal tube and black sheath					
à l'unité		CEV8649BGPU	CEV649BGPU	CEV9649BGPU			
Pack 3		CEV8649GPU	CEV649GPU	CEV9649GPU			
		Black sheath for metal tube - Pack 3					
		CEV8649C5U	CEV649C5U	CEV9649C5U			

Nota:
For cleaning, the insert and the wire insert must be disassembled.



NON Modular				
Complete instruments				
Jaws Scale 1/1	Handle	Working length		
		Short	Standard	
 Straight scissors, serrated blades, 10mm	 Angled	Montupet CEV804 235 mm	Manhès CM104 355 mm	
	 Axial	CEV904 235 mm	-	
 Straight scissors delicate serrated blades, 10mm	 Angled	-	Manhès CM106 355 mm	
 Curved scissors, Serrated blades, 10mm	 Angled	-	CEV114MU 355 mm	
	 Axial	-	CEV514MU 335 mm	





NON Modular





Complete instruments

Jaws Scale 1/1	Handle	Working length
 <p>Curved scissors Serrated blades, 25 mm</p>	 <p>Angled</p>	<p>CEV404 340 mm</p>
	 <p>Axial</p>	<p>CEV503 350 mm</p>

Modular

 <p>Curved scissors, serrated blades, Double-action jaws 25 mm</p>	 <p>Rotatable 44 -> 45</p>	<p>CEV653-1 365 mm</p>
---	--	-----------------------------------





Modular				
Inserts			Handle	
Jaws Scale 1/1	Working length			Page #
	Short	Standard	Large	
 Straight clamp insert 25mm jaws	CEV8626I 250 mm	CEV626-1 350 mm	-	 Rotatable 40 -> 45
 Curved clamp insert Double-action jaws 25mm jaws	CEV8627I 255 mm	CEV627I 355 mm	CEV9627I 455 mm	Non rotatable 46 - 47 

NON Modular		
Complete instruments		
Jaws Scale 1/1	Handle	Working length
		Standard
 Debakey Straight clamp 20mm jaws	 Axial, with ratchet	Debakey CEV526 350 mm
 Desmaizieres Straight clamp 20mm jaws	 Angled, with long ratchet	Desmaizieres CEV527 365 mm

NON Modular









Complete instruments

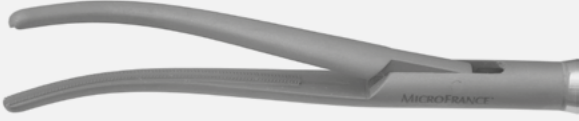



	Jaws Scale 1/1	Handle	Working length
	 <p>Dulucq Left curved, 60mm jaws</p>	 <p>Axial, with ratchet</p>	<p>Dulucq CEV570 400 mm</p>

	Modular		
	Inserts		Handle
	Jaws Scale 1/1	Working length	Page #
 <p>Delaitre Left curved, 45mm jaws</p>	<p>CEV635-1 385 mm</p>	 <p>Rotatable 44 -> 45</p> 	

NON Modular

Complete instruments



Jaws Scale 1/1	Handle	Working length
 <p>Querleu Left curved, 45mm jaws</p>	 <p>Angled with long ratchet</p>	<p>Querleu CEV435-1 375 mm</p>
 <p>Delaitre Left curved, 45mm jaws</p>	 <p>Axial, with ratchet with safety lock</p>	<p>Querleu CEV535 385 mm</p>
 <p>Querleu Right curved, 45mm jaws</p>	 <p>Angled with long ratchet</p>	<p>Delaitre CEV505 385 mm</p>
 <p>Curved jaws 75mm jaws</p>	 <p>Axial, with ratchet with safety lock</p>	<p>Querleu CEV435-2 375 mm</p>
		<p>CEVA112 320 mm</p>







Modular			
	Inserts		Handle
	Jaws Scale 1/1	Working length	Page #
	 <p style="text-align: center;">Straight clamp insert 65x7mm jaws Ø 10mm</p>	<p>CEV608-1 400 mm</p>	 <p style="text-align: center;">Rotatable 44 - 45</p> 
	 <p style="text-align: center;">Annibale Straight clamp insert Double-action jaws 65x7mm jaws Ø 10mm</p>	<p>Annibale CEV608D 400 mm</p>	

NON Modular

Complete instruments



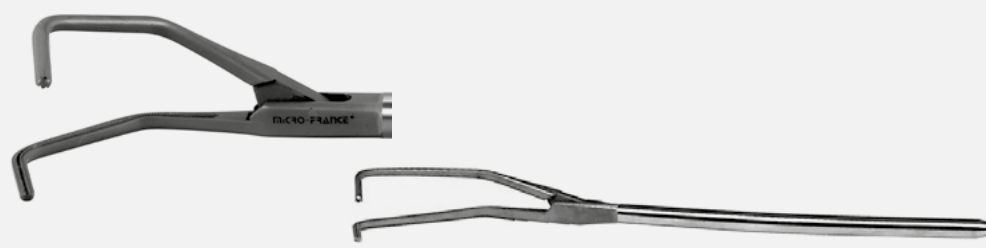

Jaws Scale 1/1	Handle	Working length
	 <p>Angled with long ratchet</p>	<p>Delaitre CEV431-65 390 mm</p>
<p>Straight clamp, 65x7mm jaws Ø 10mm</p>	 <p>Axial, with ratchet with safety lock</p>	<p>CEV508 400 mm</p>

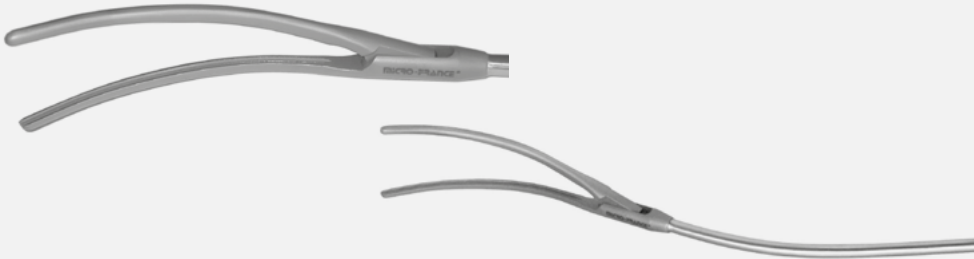

NON Modular			
Complete instruments			
Scale 1/1	Jaws	Handle	Reference
  <p>Satinisky Angled clamp, curved tube, working length 260 mm, 110 mm jaws</p>			CEVA101
 <p>Angled clamp, curved tube, working length 250 mm, 90 mm jaws</p>		 <p>Axial, with ratchet with safety lock</p>	CEVA102
 <p>Satinisky Angled clamp, curved tube, working length 240 mm, 80 mm jaws</p>			CEVA103
 <p>Angled clamp, curved tube, working length 290 mm, 110 mm jaws</p>			CEVA104 290 mm

NON Modular

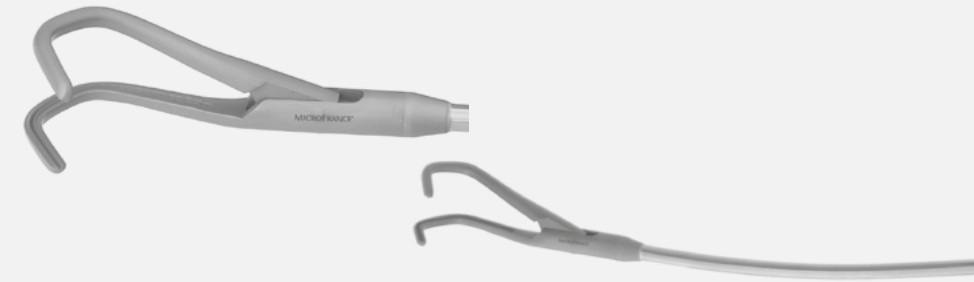
Complete instruments

Scale 1/1	Jaws	Handle	Working length
	 <p>Desmaizieres Angled clamp, curved tube, working length 270 mm, 85 mm jaws</p>		CEVA110
	 <p>Desmaizieres Angled clamp, curved tube, working length 270 mm, 90 mm jaws</p>	 <p>Axial, with ratchet with safety lock</p>	CEVA528
	 <p>Desmaizieres Angled clamp, curved tube, working length 220 mm, 60 mm jaws</p>		CEVA529

Temporary Clamps

 <p>CEV565 + CEV560</p>		
<p>Jaws Scale 1/1</p>		
	<p>Straight vascular clamp 15x3mm Pack 2</p>	<p>Sartori CEV568</p>
	<p>Straight vascular clamp 25x3mm Pack 2</p>	<p>Begin CEV565</p>
	<p>Choledoque clamp 35x4mm Pack 2</p>	<p>Begin CEV566</p>
	<p>Intestinal clamp 45x5mm Pack 2</p>	<p>Begin CEV567</p>

Clamp applicator, Ø 10 mm

NON Modular			
Jaws Scale 1/1	Handle		Working length
  <p>Clamp applicator 360mm</p>		<p>Axial, with ratchet</p>	<p>Begin CEV560</p>

Modular		
  <p>Clamp applicator insert for tube Ø10mm 310mm</p>	 <p>Rotatable 44 -> 45</p>	<p>CEV560-1 355 mm</p>

Clips applicator







NON Modular









Complete instruments

	NON Modular		
	Complete instruments		
Jaws Scale 1/1	Handle		Working length
 Clip applicator for Tl300 et LC300 clips Ø 10mm	 Angled with spring		CEV310 335 mm

Circular suturing holder insert

Modular

	Modular		
	 Morino Circular suturing holder insert Double-action jaws Ø 10mm	 Rotatable 44 -> 45	
 Massard Circular suturing holder insert Ø 5mm	 Rotatable 40 -> 45 Non rotatable 46 - 47 		Massard CEV622IU 335 mm

Modular			
Rotatable Instruments			
Angled handles with black rotatable ring Scale 1/3			
 with ratchet	CEV1019T5BU Large pattern	 with ratchet	CEV10195CU
 with ratchet	CEV10195DU	 with ratchet	CEV10195RU
 without ratchet	CEV1039T5TBU Large pattern	 without ratchet	CEV10395DU
 without ratchet	CEV10395RU	 Insulated handle without ratchet	CEV1039G5U

Tube for angled handles, 5 et 3.5mm
see page 43

Modular

Rotatable Instruments

Axial handles with black rotatable ring
Scale 1/3



CEV6285R

with ratchet



CEV628P5

with ratchet



CEV6385RU

without ratchet



CEV728T5

with long ratchet

Tube for rotatable axial handles, 5 et 3.5mm
see page 43



Modular

Rotatable Instruments

Ergonomic handles with black rotatable ring
Scale 1/3



CEV720BRUC

Large ergonomic handle
with ratchet



CEV720RU

Fine ergonomic handle
with ratchet



CEV7285RU

Elhadad
Fine ergonomic handle
with ratchet







CEV728BR5U

Large ergonomic handle
with ratchet

Tube for rotatable ergonomic handles, 5 et 3.5mm
see page 43

Insulated tubes - 5 mm



Modular		
Rotatable instruments		
Working length		
Short 210mm	Standard 310 mm	Long 410mm
		
Black insulated tube		
CEV8649T5TBU	CEV649T5BU	CEV9649T5TBU
		
Yellow insulated tube		
CEV8646B5U	CEV646B5U	CEV9646B5U
		
Blue insulated tube		
CEV8647B5U	CEV647B5U	CEV9647B5U
		
Green insulated tube		
CEV8648B5U	CEV648B5U	CEV9648B5U

Metal tube and Pack of 3 black sheaths









		
Metal tube 5mm diameter for black sheath		
CEV8649B5U	CEV649B5U	CEV9649B5U
		
Black sheath 5mm diameter for tube Pack 3		
CEV8649C5U	CEV649C5U	CEV9649C5U



Modular

Rotatable Instruments

Handles with grey rotatable ring
Scale 1/3

 <p>Angled handle with long ratchet</p>	 <p>Angled handle without ratchet</p>
 <p>3 teeth</p> <p>Axial handle with ratchet</p>	 <p>Axial handle without ratchet</p>
 <p>Fine ergonomic handle with ratchet</p>	 <p>Large ergonomic handle with ratchet</p>
 <p>Axial handle with long ratchet</p>	<p>Tube for rotatable handles for \varnothing 5 and 10 mm non-insulated tube see page 45</p>



Modular

Rotatable instruments

Working length

Short

Standard

Large



Non-insulated tube for rotatable instrument \varnothing 10mm

CEV864910B
215mm

CEV649-10B
305mm

–







Non-insulated tube for rotatable instrument \varnothing 5mm

CEV8649X5
210mm

CEV649X5
310mm

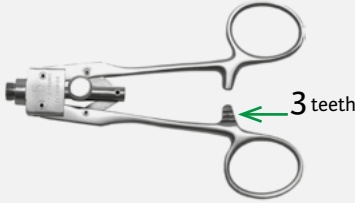
CEV9649X5
410mm

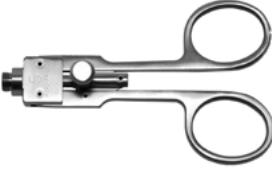
Non Rotatable handles - 5 mm - for black insulated tube

Modular	
Non rotatable Instruments	
Handles without rotatable ring Scale 1/3	
 Angled handle with long ratchet CEV1019T5NUC	 Axial handle with ratchet CEV628-5N
 Angled handle with long ratchet CEV10195NAU	 Axial handle without ratchet CEV638T5NU
 Angled handle without ratchet CEV1039T5NU	

Black insulated tube for non-rotatable instrument \varnothing 5mm

 Black insulated tube for non-rotatable instrument \varnothing 5mm		
Working length		
Short 210mm	Standard 310mm	Large 410mm
CEV8649T5NU	CEV649T5NU	CEV9649T5NU

Non Rotatable handles - 5 mm - for non-insulated tube

Modular

Non rotatable instruments

Handles without rotatable ring
Scale 1/3



 <p>CEV720</p> <p>Fine ergonomic handle with on/off ratchet</p>	 <p>CEV720B</p> <p>Large ergonomic handle with on/off ratchet</p>
--	---

Non-insulated tube for non-rotatable instrument ø 5mm



 <p>Non-insulated tube for non-rotatable instrument ø 5mm</p>		
<p>Working length</p>		
<p>Short 210mm</p>	<p>Standard 310mm</p>	<p>Large 410mm</p>
<p>CEV8649P5</p>	<p>CEV649P5</p>	<p>CEV9649P5</p>

Bipolar cables 4.5 m



CP393-2

Bowa Emc Lamidey Valleylab











CP393-3

Erbe VIO ICC ACC
(except international)
Storz Wolf











CP393-4









Aesculap Berchtold Martin
Sutter BM 780 II

Modular								Handles Non rotatable
Inserts & Tubes								
Jaws Scale 1/1	Working length							
	Short		Standard		Large			
	Insert	Tube 1/3	Insert	Tube 1/3	Insert	Tube 1/3		
	 Mouiel 15x5mm	CEV86341A 245 mm		CEV634-1A 340 mm		CEV9634-1A 430 mm		 CEV669B Angled handle
	 with hook 15x5mm	-		CEV632-1A 340 mm		CEV96321A 430 mm		 CEV669BG Gayet Ergonomic handle
	 Gayet 20x5mm	CEV86361A 250 mm		CEV636-1A 345 mm		CEV96361A 435 mm		 MCEN54P Dessi Angled handle
	 Vallancien with teeth 20x5mm	-		CEV6371 345 mm		-		
			CEV86795B 210 mm		CEV6795B 310 mm		CEV96795B 395 mm	











NON Modular					
Complete instruments					
Jaws Scale 1/1	Handle		Working length		
			Short	Standard	Large
 15x5mm	 Angled	CEV834 240 mm	Mouiel CEV134 360 mm	–	
	 Ergonomic with graduated tube 100mm	–	Gayet CEV134BG 360 mm	Gayet CEV9134BG 450 mm	
	 Axial	–	CEV580-2 365 mm	–	
 15x5mm with hook	 Angled	–	CEV132 360 mm	–	
 Gayet 20x5mm	 Angled	–	Gayet CEV136 365 mm	–	



Modular					
Inserts & Tubes					Handles Non rotatable
Jaws Scale 1/1	Working length				
	Standard		Large		
	Mors	Tube 1/3	Mors	Tube 1/3	
 Manhès Spatula jaws 10x3mm	CEV630-1A 340 mm		CEV9630-1A 425 mm		 CEV669B Angled handle
 Botella Triangle fenestrated jaws 12x5mm	CEV633-1A 340 mm		CEV96331A 430 mm		 Gayet CEV669BG Ergonomic handle
 Spatula angled jaws 10x2mm	CEV630C 340 mm		-		 MCEN54P Dessi Angled handle
		CEV6795B 310 mm		CEV96795B 395 mm	



NON Modular				
Complete instruments				
Jaws Scale 1/2	Handle		Working length	
			Short	Standard
 Spatula jaws 10x3mm		Angled	Montupet CEV830 240 mm	Manhès CEV130 360 mm
 Botella Triangle fenestrated jaws 12x5mm		Angled	—	Botella CEV133 360 mm
		Axial	—	Botella CEV580-3 360 mm
—	—	—	—	—
 Delicate triangular jaws 8x5mm		Angled	—	Botella CEV133-1 360 mm
 Manhès 10x2mm		Angled	—	Manhès CM131 360 mm



Modular

Hook jaws

Scale 1/1



CEV229-2A
Crochet # 2
Pack 3



CEV229-3A
Crochet # 3
Pack 3



CEV229-4A
Crochet # 4
Pack 3



CEV2295A
Crochet # 5
Pack 3

Hook handles

Scale 1/3

CEV225A

Working length 430mm



CEV82291

Working length 230mm



CEV229-1A

Working length 350mm



CEV9229-1

Working length 450mm



CEV229B

Working length 380mm



Page 54

Monopolar hook, non modular

Scale 1/3



1/1



CEV225

Working length 430mm



1/1



PÉRISSAT
CEV230-1

Working length 330mm







1/1





MONTUPET
CEV825

Working length 220mm

Retractable knife, monopolar electrode

		NON Modular	
		Complete instruments	
1/3			
1/1		CEV135-5	Retractable knife ø 5mm 300mm without knife blades SM63 / SM64 / SM65
1/3			
1/1		CM109 Manhès	Retractable monopolar electrode ø 5mm 320mm

Monopolar palpation probe

1/3			
1/1		CEV443 Delaitre	Monopolar palpation probe ø 5mm 350mm

Monopolar cables - 3.5 m



CP391E
Erbe Storz Wolf
ACC ICC/VIO



CP391M
Aesculap Berchtold Martin
Erbe T Serie Lamidey
Sutter BM-780 II



CP391V
Bowa Bovie Conmed Valleylab

Accessories for knife CEV135-5
Knife blades



SM63^{(D)*}











SM65^{(D)*}









SM64^{(D)*}

^(D) Distributed by Integra MicroFrance SAS (France) - For corresponding manufacturer part numbers, see table in annex.
* Please check with your sales representative availability of this product in your country.

Palpation probe

	1/3				
	1/1		CEV204 320 mm - Ø 5mm	Round probe	
	1/1		CEV204G45 450 mm - Ø 5mm	Round probe, graduated 10 to 150 mm	
	1/1		CEV205 340 mm - Ø 5mm	Flat probe	
	1/3				
	1/1		CEV207 410 mm - Ø 5mm	Double ended probe, round end flap graduated 10 to 150 mm	

Articulated retractor

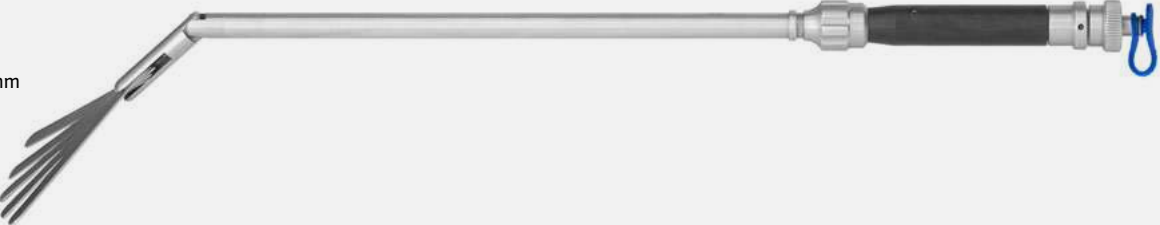
			Flexible retractor CEV416 380mm - Ø 5mm		1/3
			Retractor with 3 blades 35mm CEV413 370mm - Ø 5mm		1/3
	Nouaille		Retractor diamond design CEV425 320mm - Ø 5mm		1/3
			Retractor with 3 blades 65mm CEV423 400mm - Ø 10mm		1/3
			Retractor with 5 blades 65mm CEV453 400mm - Ø 10mm		1/3
			Articulated retractor with 5 blades 65mm CEV453A 330mm - Ø 10mm		1/3



NON Modular

Complete instruments

Flexible tension arm delivered with instruments holder CEV980-3

Accessories for flexible tension arm

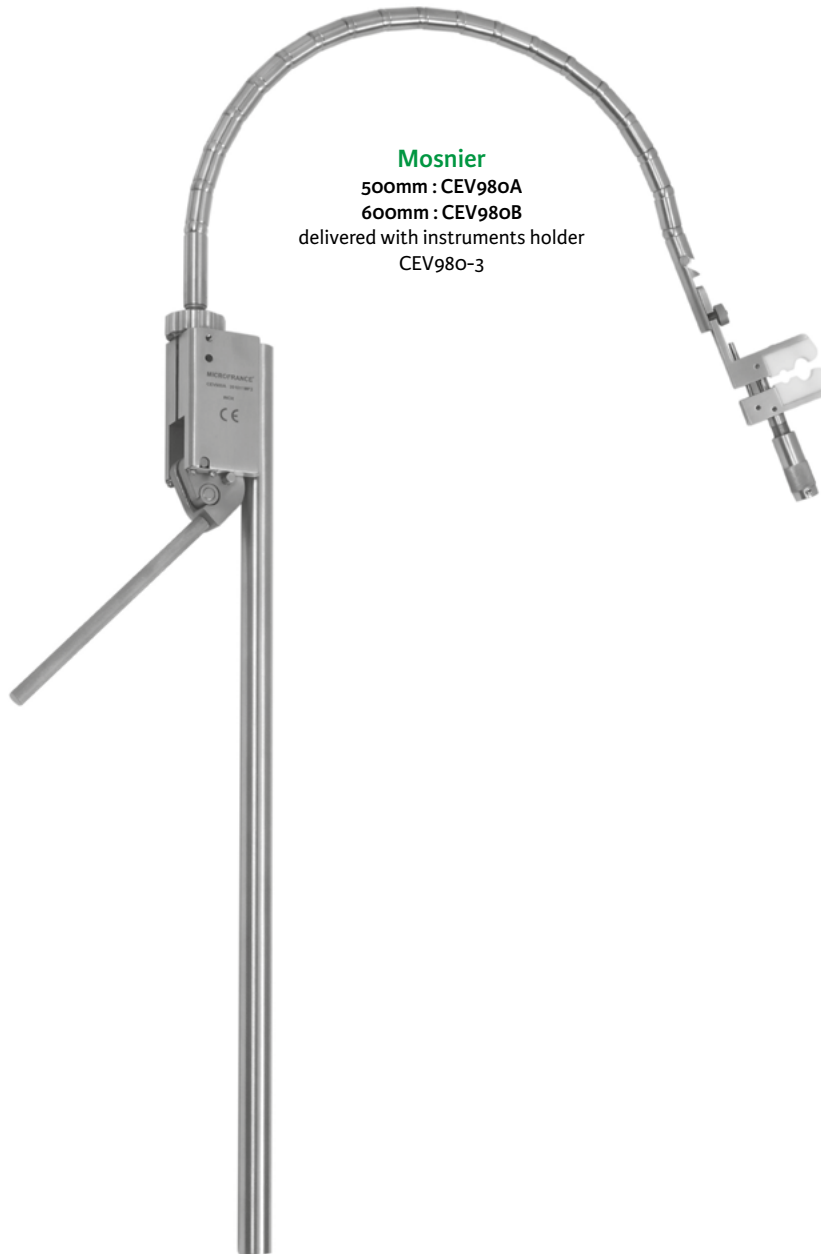

Mosnier
500mm : CEV980A
600mm : CEV980B
delivered with instruments holder
CEV980-3

CEV980-3
Instruments holder
Ø 5 et 10mm
Mosnier



CEV984
Operating table
clamp
with screw

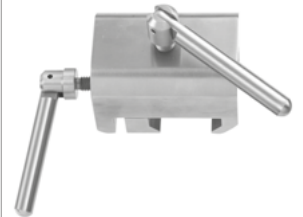

CEV985
Operating table
clamp



CM201 irrigation suction pump accessories**

Suction irrigation tubes
Sterile - Pack 10

CM217S^(D)*



Eyes suction irrigation tubes for handle CM201-9**

1/1

«L» Working length

1/3

Eyes hydro cannula Ø 10mm	<p>CM20132H10 L 320mm</p> <p>CM20128H-10 L 280mm</p>	
Eyes hydro cannula Ø 5mm	<p>CM20132H-5 L 320mm</p> <p>CM20128H-5 L 280mm</p> <p>CM20140H5 L 400mm</p>	
Eyes cannula Ø 5mm	<p>CM20132L-5 L 320mm</p>	

Cleaning sleeve for telescope



Cleaning sleeve for telescope odeg
Ø 10mm 300mm
Scale 1/3





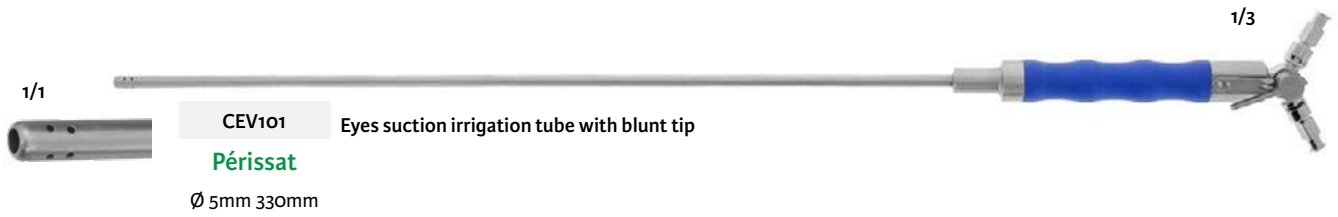

CEV81

^(D) Distributed by Integra MicroFrance SAS (France) - For corresponding manufacturer part numbers, see table in annex
* Please check with your sales representative availability of this product in your country
** Reference discontinued



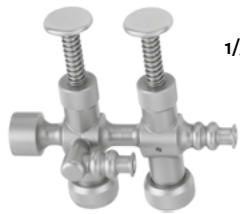
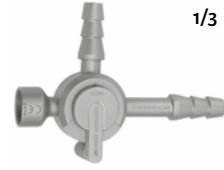

Suction irrigation tube

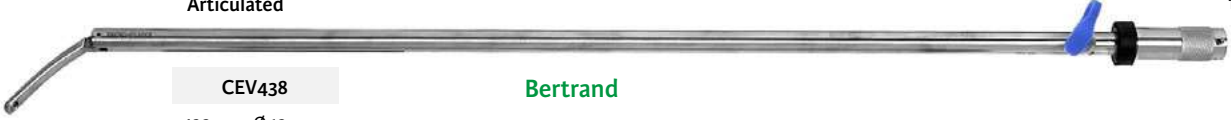

Modular suction irrigation tube

Eyes suction irrigation tube Ø 5mm		Handles for tube Ø 5mm
<p>1/1</p>  <p>195mm CEV8103D5</p> <p>295mm CEV103-5</p> <p>395mm CEV9103D5</p>	<p>1/3</p>  <p>CEV103AH</p>	
<p>1/1</p> <p>Blunt tip</p>  <p>195mm CEV8103G5</p> <p>295mm CEV103G5</p> <p>395mm CEV9103G5</p>	<p>1/3</p>  <p>CEV103BG</p> <p>1/3</p>  <p>CEV103GH</p>	
Eyes suction irrigation tube Ø 10mm		Handles for tube Ø 10mm
<p>1/1</p> <p>CEV103-10</p> <p>295mm</p>  <p>1/3</p> 	<p>1/3</p>  <p>CEV103AH</p>	
<p>1/1</p> <p>CEV103P</p> <p>Prete</p> <p>410mm</p> 		





Wire-pass

	Articulated	CEV438 420mm - Ø 10mm	Bertrand		1/3
	Articulated	CEV438B 335mm - Ø 5mm			1/3
	Retractable	CEV438D5 430mm - Ø 5mm	Morino		1/3
	Retractable	CEV456 170mm - Ø 2.5mm			1/3

Mintz set for punction

Sleeve - Ø 2.5mm - 240mm	CM170-1		1/3
Sharp trocar	CM170-2		
Smooth trocar	CM170-3		

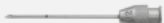
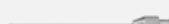
Needles

Insufflation needle with luer-lock		1/3
120mm	CEV60-120	
150mm	CEV60-150	
Punction needle with luer-lock		1/3
Ø 5mm - 300mm	CEV65	
Ø 1.2mm - 40mm	CEV24F	
Ø 2.0mm - 40mm	CEV24G	
	with a lateral perforation to purge	 2/1

Cholangiography

1/3



Cholangiography forceps

CEV448

350mm - Ø 2.5mm

1/1



1/3



Cholangiography needle

CEV440

230mm - int Ø 2.5mm

Sealing cap

CEV440P6

Pack 6



1/3



Sealing cap

CEV103P6

Pack 6

Guide sleeve for cholangiography

CEV455

170mm - Ø 4.0mm

Falchero



Cholédoscopy

1/3



Mauras

Guide sleeve for choledoscopy

CEV449

190mm - Ø 8mm

delivered with one guide CEV449G

1/3

Spare parts

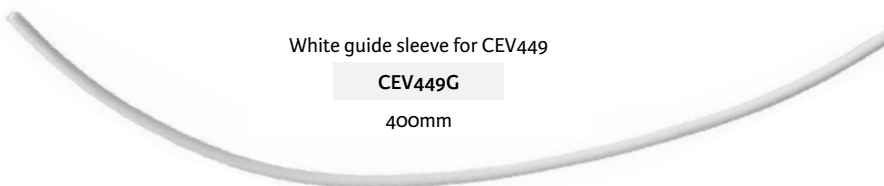

White guide sleeve for CEV449

CEV449G

400mm









Sealing cap

CEV105P6

Pack 6



Trocar with metal cannula



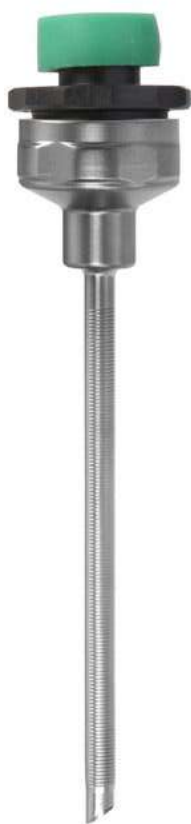



			Working length	
			50 mm	80 mm
Trocar tip	smooth		CEV8143A4	CEV143A4
	pyramidal		CEV8143A3	CEV143A3
Sealing cap	green		CEV103P6 Pack 6	
Trocar head	magnetic		CEV177A3 Delivered complete with 1 magnetic valve and 1 green sealing cap	
	silicone		CEV127T3 Delivered complete with 1 silicone valve and 1 green sealing cap	
Valve for trocar head	magnetic		CEV179A5 Pack 6	
	silicone		CEV125P6 Pack 6	
Metal cannula, crenelated	with stopcock		CEV8143A7	CEV143A7
	without stopcock		CEV8143B7	CEV143B7



Scale 1/1

Composite trocar with silicone valve





			Working length	
			45 mm	70 mm
Trocar tip 	smooth 		CEV8826M	CEV326M
	pyramidal 		CEV8826P	CEV326P
Sealing cap 	green		CEV103P6 Pack 6	
Valve for trocar head 	silicone		CEV125P6 Pack 6	
Trocar body composed of 1 trocar head with composite cannula and silicone valve	smooth cannula without stopcock 		CEV8826L	CEV326L
	threaded cannula without stopcock 		CEV8826V	CEV326V



Scale 1/1



CEV8126V

			Working length			
			50 mm	80 mm	100 mm	120 mm
Trocar tip 	blunt 		CEV8145A5	CEV145A5	CEV7145A5	CEV9145A5
	sharp 		CEV8145A3	CEV145A3	CEV7145A3	CEV9145A3
Sealing cap	blue 		CEV105P6 Pack 6			
Head of trocar	magnetic valve 		CEV177A5 delivered with one magnetic valve and one blue sealing cap			
	silicone valve 		CEV127T delivered with one silicone valve and one blue sealing cap			
Valve for head of trocar	magnetic 		CEV179A5 Pack 6			
	silicone 		CEV125P6 Pack 6			
Sleeve	with stopcock	screw 	CEV8145A6	CEV145A6	CEV7145A6	CEV9145A6
		smooth 	CEV8145A7	CEV145A7	CEV7145A7	CEV9145A7
	without stopcock	screw 	CEV8145B6	CEV145B6	CEV7145B6	CEV9145B6
		smooth 	CEV8145B7	CEV145B7	CEV7145B7	CEV9145B7

Body of trocar 5 mm diameter with silicone valve with screw sleeve, without stopcock		CEV8126V Working length 45 mm Montupet	CEV126V Working length 75 mm
Trocar tip for body of trocar 5mm diameter 	blunt 	CEV8126PM Working length 95 mm Montupet	CEV126PM Working length 120 mm
	sharp 	CEV8126P Working length 95 mm	CEV126P Working length 120 mm



Scale 1/1

				Working length	
				90 mm	130 mm
Trocar tip		blunt		CEV150-4	CEV9150A4
		sharp		CEV150-3	CEV9150A3
Sealing cap		red		CEV110P6 Pack 6	
Head of trocar		magnetic valve		CEV177A10 delivered with one magnetic valve and one red sealing cap	
		silicone valve		CEV127T10 Delivered with one silicone valve and one red sealing cap	
Valve for head of trocar		magnetic		CEV179A10 Pack 6	
		silicone		CEV125Q6 Pack 6	
Sleeve	with stopcock	screw		CEV150A6	CEV9150A6
		smooth		CEV150A7	CEV9150A7
	without stopcock	screw		CEV150B6	CEV9150B6
		smooth		CEV150B7	CEV9150B7

Dulucq smooth trocar tip palpator probe

Scale 2/3

Dulucq



CEV480







Ø 10 mm

Working length 180mm



Scale 1/1

			Working length	
			90 mm	130 mm
Trocar tip 	blunt 	CEV172A4	CEV9172A4	
	sharp 	CEV172A3	CEV9172A3	
Sealing cap	Orange 	CEV112P6 Pack 6		
Head of trocar	magnetic valve 	CEV177A12 delivered with one magnetic valve and one orange sealing cap		
	silicone valve 	CEV127T12 delivered with one silicone valve and one orange sealing cap		
Valve for head of trocar	magnetic 	CEV179A12 Pack 6		
	silicone 	CEV125Q6 Pack 6		
Sleeve	with stopcock	screw 	CEV172A6	CEV9172A6
		smooth 	CEV172A7	CEV9172A7
	without stopcock	screw 	CEV172B6	CEV9172B6
		smooth 	CEV172B7	CEV9172B7

	Ø 5.5 mm			Ø 10.5 mm		Ø 12.5 mm	
1/3	CEV805I	CEV105	CEV105I	CEV110I	CEV112I	CEV122I	CEV212
							
	Working length 50mm with stopcock	Working length 80mm without stopcock	Working length 80mm with stopcock	Working length 80mm with stopcock	Working length 120mm with stopcock	Working length 80mm with stopcock	Working length 120mm without stopcock
	Montupet						

Spring for trumpet valve trocar



CEV105R
Ø 5.5mm



CEV110R
Ø 10.5mm



CEV112R
Ø 12mm

Sealing cap for trumpet valve trocars
see page 68



			Diameter		
			Ø 5.5mm	Ø 10mm	Ø 12.5mm
Trocar tip		blunt 	CEV145-4	CEV150-4	—
		sharp 	CEV145-3	CEV150-3	CEV172-3
Sealing cap			 CEV105P6 Pack 6	 CEV110P6 Pack 6	 CEV112P6 Pack 6
Head of trocar	with stopcock		 CEV178-5	 CEV278-10	 CEV278-12
	without stopcock		 CEV177-5	—	 CEV177-12
Sleeve	without stopcock	screw	 CEV145-6	 CEV150-6	 CEV172-1
		smooth	 CEV145-7	 CEV150-7	—

Sealing cap for trocar



CEV103P6

Ø 3.5mm

Pack 6



CEV105P6

Ø 5.5mm

Pack 6



CEV110P6

Ø 10.5mm

Pack 6



CEV112P6

Ø 12mm

Pack 6

Reducer sleeve for trocar

1/1



CEV155A

from Ø 10.5 to 5.5mm



CEV156A

from Ø 12/13 to 5.5mm



CEV181A

from Ø 12/13 to 10.5mm

1/3



CEV153

135 mm

from Ø 5.5 to 3.5mm



CEV155

135 mm

from Ø 10.5 to 5.5mm



CEV155-1

65 mm

from Ø 10.5 to 5.5mm



CEV155P

135 mm

from Ø 12/13 to 5.5mm

Tube
interne
Ø 5mm



CEV156

135 mm

from Ø 12/13 to 10.5mm



CEV181

135 mm

from Ø 12/13 to 10.5mm



CEV181-1

65 mm

from Ø 12/13 to 10.5mm

Double retractor

1/3



Descottes

CEV417

200 mm

pair

Double retractor, blunt



CEV418

200 mm

pair

Double retractor, blunt



Mosnier









CEV419

160 mm







pair

Double retractor, blunt



Trocars 85mm

Scale 1/3	Blunt trocar tip	Sharp trocar tip	Flexible threaded cannula
	CET105-1	CET105-2	CET105-3
Ø 5.5mm			
	CET110-1	CET110-2	CET110-3
Ø 10.5mm			
	CET112-1	CET112T2	CET112-3
Ø 12.5mm			
Joints : See page 68			

Forceps, non modular instruments

Jaws Scale 1/1	Handle	Reference
 Manhès curette forceps 12x5mm Working length 355mm	 Angled	CM107U
 curette forceps 12x5mm, Double-action jaws Working length 355mm	 Angled	CEV444
 fenestrated forceps 20x5mm, curved tube Working length 340mm	 Axial, with ratchet  Curved tube	CET525

Modular forceps

	 Manhès curette insert 12x5mm Ø 5mm	Working length		
		Short	standard	Large
 Rotable : page 40 - 45  Non rotatable : page 46 - 47	CEV8107IU 245mm	CEV107IU 345mm	CEV9107IU 445mm	



Belghiti	Soubrane	CEV392P20	Dousset	Gayet	Partenski
215mm	215mm	215mm	290mm	220mm	190mm
CEV392D20	CEV392S20	CEV392P20	CEV392D30	CEV392G24	CEV392R15
straight	straight	straight	straight	straight	bayonet
Jaws 2mm	Jaws 2mm double irrigation	Serrated jaws 2mm	Jaws 3mm double irrigation	Jaws 5x15mm	Jaws 4x10mm

Bipolar cables - 4,5 m



CP393-2
Bowa Emc Lamidey Valleylab













CP393-3
Erbe VIO ICC ACC (except international) Storz Wolf



CP393-4
Aesculap Berchtold Martin
Sutter BM-78o II

Semi-modular













Insert with tubes		Handle
Insert insulated tube Scale 1/1	Working length	Page #
 Babcock Insert	CEV391IU 335 mm	   Rotatable 40 -> 45
 Curved scissors insert, serrated blades 8 mm	CEV393IU 330 mm	
 Straight scissors insert, serrated blades 8mm	CEV394IU 330 mm	
 Fenestrated insert, 3x12mm jaws	CEV395IU 335 mm	
 Alligator jaws insert 6 mm	CEV396IU 330 mm	
 Dissector insert, medium curved 10 mm jaws	CEV398IU 340 mm	
 Allis Grasping insert	CEV399IU 335 mm	
-	-	
-	-	



CEV39L
Adapter cleaning luer-lock for tube insert











NON Modular			
Complete instruments			
Jaws Scale 1/1	Handle		Working length
 Babcock forceps	 Angled with long ratchet		CEV391BU 355 mm
-	-	-	-
 Straight scissors, serrated blades, 8mm	 Angled		CEV394BU 350 mm
 Fenestrated forceps, 3x12mm jaws	 Angled with long ratchet		CEV395BU 355 mm
-	-	-	-
-	-	-	-
 Allis Grasping forceps with teeth	 Angled with long ratchet		CEV399BU 355 mm
 Needle-holder, tungsten straight jaws	 Axial		CEV992B 340 mm
 Needle-holder, tungsten left curved jaws			CEV992C 340 mm

NON Modular

Complete instruments : Bipolar forceps

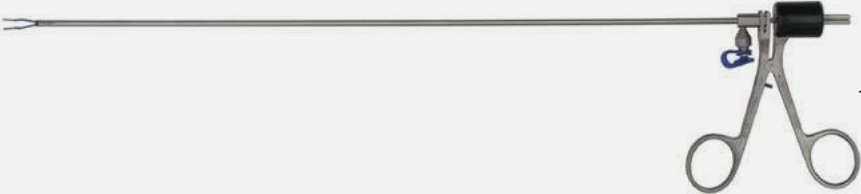

Jaws Scale 1/1	Handle	Working length
 <p>Gayet Forceps, fenestrated jaws, 10x3mm, graduated tube 100mm</p>	 <p>Ergonomic bipolar</p>  <p>1/3</p>	<p>CEV397BG 305mm</p>
 <p>Forceps, 2mm spatula jaws</p>	 <p>Ergonomic bipolar</p>  <p>1/3</p>	<p>CEV397C 305mm</p>
 <p>Forceps, 2mm serrated jaws</p>	 <p>Angled bipolar</p>  <p>1/3</p>	<p>CEV397 305mm</p>

Cadière forceps



Forceps without port
Fenestrated forceps
percutaneous

CEV350

1/1

195mm



Cadière

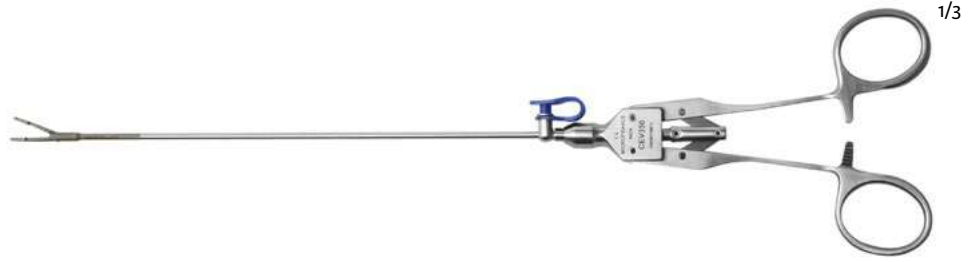

1/3

Palpation probe



Round probe Ø 3.5mm 330mm

CEV203

1/1



1/3

Monopolar hooks



1/1



CEV390B Ø3.5mm, Working length 330mm, round tip

1/3

1/1



CEV390C Ø3.5mm Working length 355mm, 90°

1/3



Page 54

Suction irrigation tube



1/1



CEV103G3

Ø 3.5mm 295mm



1/3

Graduated suction irrigation tube for handle CEV103GH or CEV103BG

Handle for suction tube CEV103G3



CEV103GH



CEV103BG

1/3

Iannelli knot pusher



1/1



CEV342

440mm working length 340mm Ø 3.5mm

1/3

1/1







CEV342E

360mm working length 340mm Ø 3.5mm

1/3



Trocart métal

			Working length	
			50 mm	80 mm
Trocar tip	blunt		CEV8143A4	CEV143A4
	sharp		CEV8143A3	CEV143A3
Sealing cap	Green		CEV103P6 Pack 6	
Head of trocar	magnetic valve		CEV177A3 delivered with one magnetic valve and one green sealing cap	
	silicone valve		CEV127T3 delivered with one silicone valve and one green sealing cap	
Valve for head of trocar	magnetic		CEV179A5 Pack 6	
	silicone		CEV125P6 Pack 6	
Metal sleeve	with stopcock		CEV8143A7	CEV143A7
	without stopcock		CEV8143B7	CEV143B7

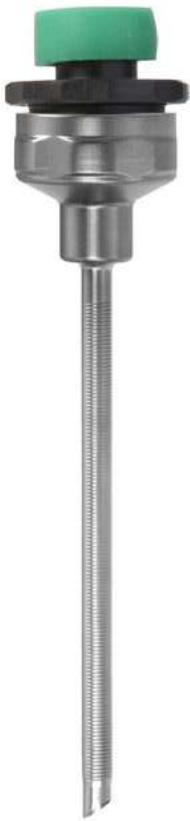







Scale 1/1







Trocart with composite sleeve and silicone valve









Scale 1/1

			Working length	
			45 mm	70 mm
Trocar tip 	blunt 		CEV8826M	CEV326M
	sharp 		CEV8826P	CEV326P
Sealing cap	green 		CEV103P6 Pack 6	
Valve for head of trocar	silicone 		CEV125P6 Pack 6	
Body of trocar with head of trocar with silicone valve and composite sleeve	with smooth sleeve without stopcock 		CEV8826L	CEV326L
	with screw sleeve without stopcock 		CEV8826V	CEV326V









Monopolar hooks









	 <p>1/1</p>	 <p>1/3</p>
	<p>CEV890 225mm Ø 3.5mm</p> <p>Montupet</p>	
	 <p>1/1</p>	 <p>1/3</p>
	<p>CEV890C 90deg 225mm Ø 3.5mm</p>	 <p>Page 54</p>

Retractable knife

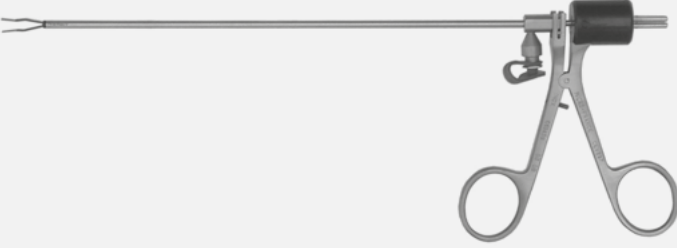
	 <p>1/1</p>	 <p>1/3</p>
	<p>CEV898 90mm Ø 3.5mm delivered with one blade CEV898L</p>	
	 <p>1/1</p>	 <p>1/3</p>
	<p>CEV898L Knife blade for CEV898 Pack 3</p>	

Suction irrigation tube



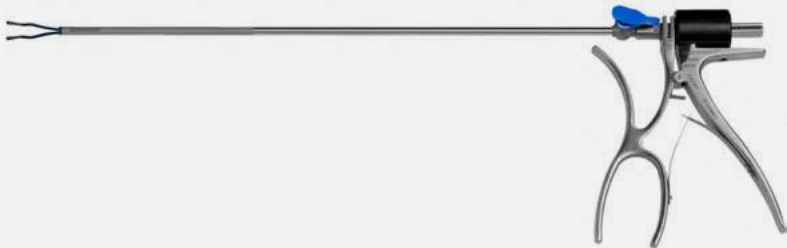







	 <p>1/1</p>	<p>Eyes suction irrigation tube, graduated 50/100/150mm</p>  <p>1/3</p>
	<p>CEV8103G3 Ø 3.5mm 195mm</p> <p>Eyes suction irrigation tube, blunt graduated 50/100/150mm for handle CEV103GH or CEV103BG</p>	 <p>CEV103GH Handle</p>
	 <p>1/1</p>	 <p>1/3</p>
	<p>CEV896 Ø 3.5mm 220mm</p> <p>Eyes suction irrigation tube with blunt tip</p>	 <p>CEV103BG Handle</p>

NON Modular			
Complete instruments : bipolar forceps			
Jaws Scale 1/1	Handle	Working length	
 Bipolar forceps 1.5mm serrated jaws	 Angled Bipolar	CEV897 250 mm	
		1/3	
 Bipolar forceps, fenestrated jaws 10x3mm jaws	 Ergonomic bipolar	CEV897BG 250 mm	
		1/3	
 Bipolar forceps 2mm serrated jaws	 Ergonomic bipolar	CEV897C 250 mm	
		1/3	



Semi-Modular











Insert with tube		Handle
Insert insulated tube Scale 1/1	Working length	Page #
 Babcock insert	CEV891IU 235 mm	 Rotatable 40 -> 45
 Curved scissors insert, serrated blades 8 mm	CEV893IU 230 mm	
 Straight scissors insert, serrated blades 8mm	CEV894IU 230 mm	
 Fenestrated insert, 3x12mm jaws	CEV895IU 235 mm	
 Allis Grasping forceps	CEV899IU 220 mm	
 Alligator jaws insert, 6 mm	CEV896IU 235 mm	
 Dissector insert, Medium curved 10 mm jaws	CEV898IU 230 mm	
	CEV39L Adapter cleaning luer-lock for tube insert	



NON Modular









Complete instruments

Jaws Scale 1/1	Handle	Working length
 Montupet Babcock forceps	 Angled with long ratchet	CEV891MU 200 mm
—	—	—
 Montupet Straight scissors, serrated blades 8mm	 Angled	CEV894MU 220 mm
 Montupet Fenestrated forceps, 3x12mm jaws	 Angled with long ratchet	CEV895MU 195 mm
 Allis Grasping forceps with teeth	 Angled with long ratchet	CEV899U 220 mm









NON Modular Complete instruments

De Lagausie instruments

Jaws Scale 1/1	Handle	Working length
 De Lagausie Fenestrated forceps, 3x12mm jaws	 Axial	CEV995MU 220 mm
 De Lagausie Straight scissors, serrated blades 8mm	 Axial	CEV996MU 220 mm
 De Lagausie Alligator forceps, 6mm serrated jaws	 Axial	CEV997MU 210 mm
 De Lagausie Dissector, medium curved 10mm jaws	 Axial	CEV998MU 220 mm

Needle-holder

 Montupet Needle-holder, tungsten straight jaws	 Angled with long ratchet	CEV892 220 mm
 Reinberg Needle-holder, straight jaws	 Axial	CEV992 220 mm
 Needle-holder, left curved tungsten jaws	 Axial	CEV992D 220 mm

Scale 1/3

Curved scissors, titanium large curved blades, 15 mm



Working length 230 mm

CEC8605GT

Adson-Brown forceps with teeth



Working length 230 mm

CEC8522

Needle-holder, tungsten straight jaws, 1 x 10 mm



Working length 230 mm

CEC8500T5

Needle-holder, titanium automatic jaws



Working length 230 mm

CEC8650T

Scale 1/2

Working length «L»



Trocar holder ring
for trocar Ø 10mm

MCLP70

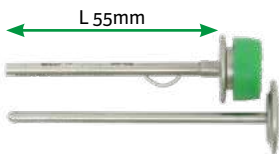

Trocar without valve 55mm
with blunt trocar tip

MCLP10

L 55mm

L 180mm

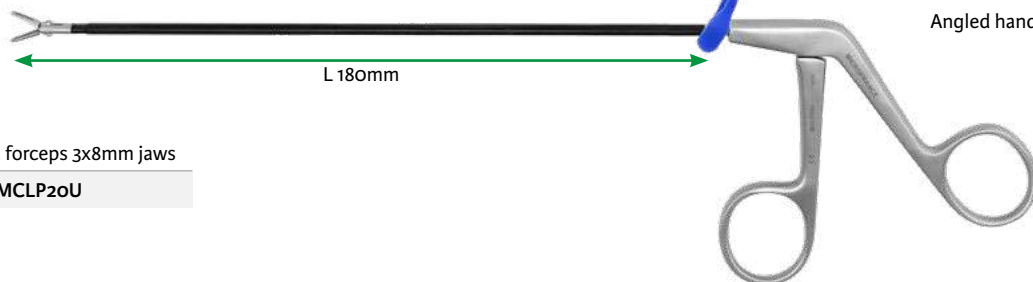

Angled handle

Fenestrated forceps 3x8mm jaws

MCLP20U



Fenestrated forceps 3x8mm jaws

MCLP25U



Axial handle

MCLP30U

L 100mm

Forceps, alligator jaws, 6mm

MCLP30U



Curved scissors, blades 4mm

MCLP40U



Axial handle

MCLP40U

L 100mm

Monopolar hook

MCLP50



MCLP50

L 100mm

Page 54

Round palpation probe

MCLP60



MCLP60

L 180mm

Double blunt retractor
180mm

MCLT10

Small size 8x35 / 15x40mm

MCLT11

large size 8x35 / 15x50mm

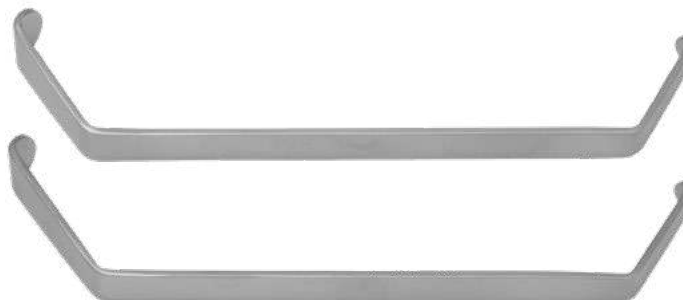

Blunt curved elevator
190mm

MCLT20

2mm

MCLT21

4mm



Peanut-holder



200mm - Ø 3mm

MCLT30

Axial handle



Suction tube elevator
200mm - Ø 3mm

MCLT40

malleable



Nerve eye suction tube
with finger control
200mm - Ø 3mm

MCLT50

malleable



Scheye biopsy rectal forceps, 5mm
Hirschsprung's disease

1/3



Curette jaws insert and tube Ø 5mm, non sterile, single use (pack 3) for biopsy



Handle non sterile, resterilizable

1/4

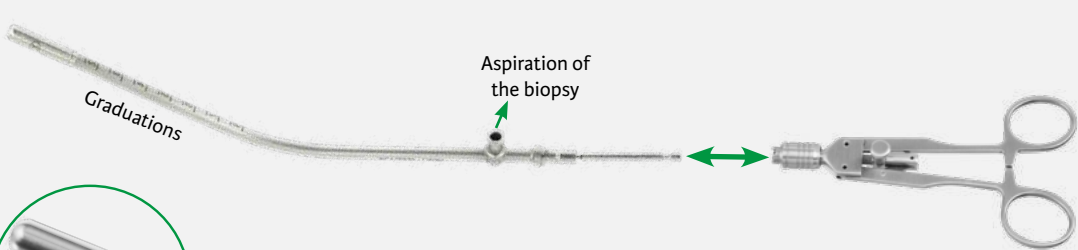

CEV504S3 Insert Ø 3mm
CEV504S5 Insert Ø 5mm

CEV504PS Axial handle



Precaution:

If the single use symbol is on the device label then this device is designed for single patient use only. Do not reuse, reprocess, or resterilize this product. Reuse, reprocessing, or resterilization may compromise the structural integrity of the device and/or create a risk of contamination of the device, which could result in patient injury, illness, or death.

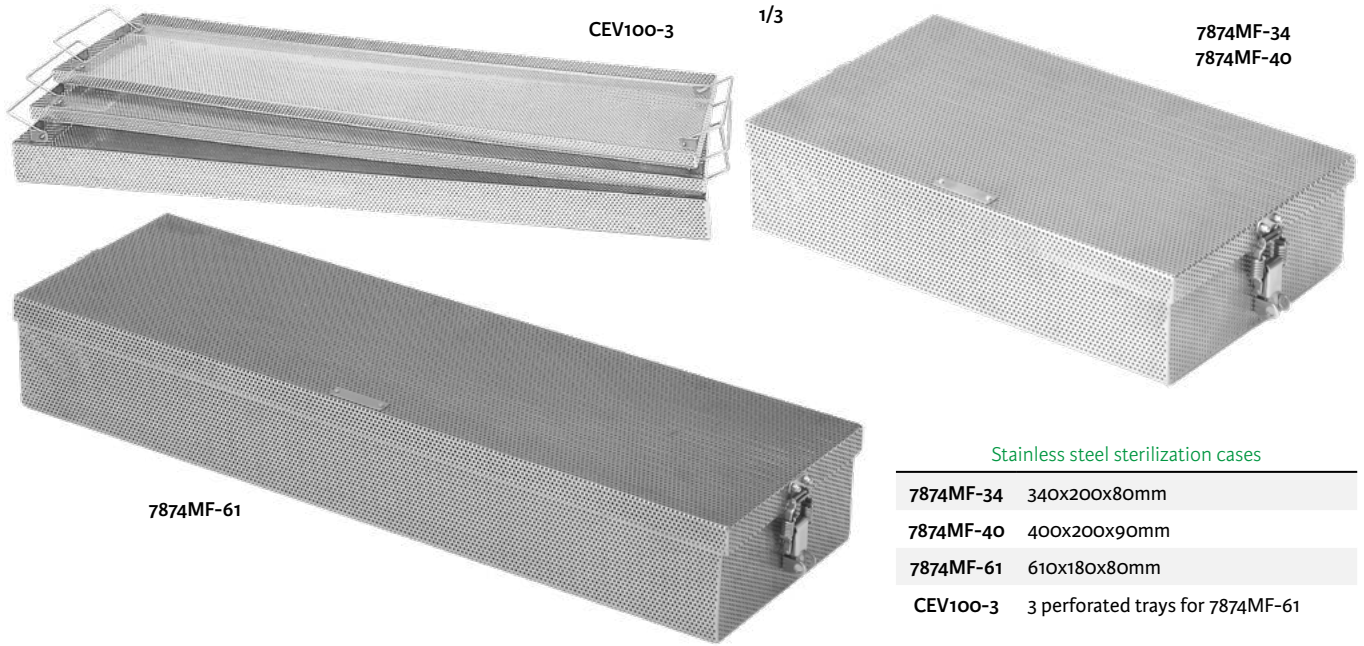

Stainless steel sterilization cases

7874MF-34	340x200x80mm
7874MF-40	400x200x90mm
7874MF-61	610x180x80mm
CEV100-3	3 perforated trays for 7874MF-61



371001
Case 530x255x150mm with 3 levels



CEV56
Stainless steel cap
for luer-lock cleaning port
Pack 1



CEV57
Silicone cap
for luer-lock cleaning port
Pack 6

Numerical index

3

3717001 86

7

7874MF-34 86
7874MF-40 86
7874MF-61 6

CEC

CEC8500T5 82
CEC8522 82
CEC8605GT 82
CEC8650T 82

CET

CET105-1 69
CET105-2 69
CET105-3 69
CET110-1 69
CET110-2 69
CET110-3 69
CET112-1 69
CET112-3 69
CET112T2 69
CET525 69

CEV

CEV24F 59
CEV24G 59
CEV39L 26, 71, 79
CEV56 86
CEV57 86
CEV60-120 59
CEV60-150 59
CEV65 59
CEV81 57
CEV100-3 86
CEV101 58
CEV103-5 58
CEV103-10 58
CEV103AH 58
CEV103BG 58, 74, 77
CEV103G3 74
CEV103G5 58
CEV103GH 58, 74, 77
CEV103P 59
CEV103P6 60, 61, 62, 68, 75, 76
CEV104IU 26
CEV105 66
CEV105I 66
CEV105P6 63, 67, 68
CEV105R 66
CEV107IU 69
CEV110I 66
CEV110P6 64, 67, 68

CEV110R 66
CEV112I 66
CEV112P6 65, 67, 68
CEV112R 66
CEV114MU 28
CEV122I 66
CEV125P6 61, 62, 63, 75, 76
CEV125Q6 64, 65
CEV126P 63
CEV126PM 63
CEV126V 63
CEV127T 63
CEV127T3 61, 75
CEV127T10 64
CEV127T12 65
CEV130 52
CEV132 50
CEV133 52
CEV133-1 52
CEV134 50
CEV134BG 50
CEV135-5 54
CEV136 50
CEV143A3 61, 75
CEV143A4 61, 75
CEV143A7 61, 75
CEV143B7 61, 75
CEV145-3 67
CEV145-4 67
CEV145-6 67
CEV145-7 67
CEV145A3 63
CEV145A5 63
CEV145A6 63
CEV145A7 63
CEV145B6 63
CEV145B7 63
CEV150-3 64, 67
CEV150-4 64, 67
CEV150-6 67
CEV150-7 67
CEV150A6 64
CEV150A7 64
CEV150B6 64
CEV150B7 64
CEV153 68
CEV155 68
CEV155-1 68
CEV155A 68
CEV155P 68
CEV156 68
CEV156A 68
CEV172-1 67
CEV172-3 67
CEV172A3 65
CEV172A4 65
CEV172A6 65
CEV172A7 65
CEV172B6 65
CEV172B7 65
CEV177-5 67
CEV177-12 67

CEV177A3 61, 75
CEV177A5 63
CEV177A10 64
CEV177A12 65
CEV178-5 67
CEV179A5 61, 63, 75
CEV179A10 64
CEV179A12 65
CEV181 68
CEV181-1 68
CEV181A 68
CEV203 74
CEV204 55
CEV204G45 55
CEV205 55
CEV207 55
CEV211U 15
CEV212 66
CEV220U 13
CEV225 53
CEV225A 53
CEV229-1A 53
CEV229-2A 53
CEV229-3A 53
CEV229-4A 53
CEV229B 53
CEV230-1 53
CEV278-10 67
CEV278-12 67
CEV310 39
CEV321 15
CEV326L 62, 76
CEV326M 62, 76
CEV326P 62, 76
CEV326V 62, 6
CEV342 74
CEV342E 74
CEV350 74
CEV390B 74
CEV390C 74
CEV391BU 72
CEV391IU 71
CEV392D20 70
CEV392D30 70
CEV392G24 70
CEV392P20 70
CEV392R15 70
CEV392S20 70
CEV393IU 71
CEV394BU 72
CEV394IU 71
CEV395BU 72
CEV395IU 71
CEV396IU 71
CEV397 73
CEV397BG 73
CEV397C 73
CEV398IU 71
CEV399BU 72
CEV399IU 71
CEV404 29
CEV405BG 3

CEV405U.....	3	CEV512.....	15	CEV622IU.....	39
CEV406IU.....	4	CEV514MU.....	28	CEV623T1U.....	26
CEV406U.....	5	CEV515.....	13	CEV624IU.....	12
CEV407IU.....	4	CEV521.....	11	CEV625CU.....	2
CEV407U.....	5	CEV525.....	3	CEV625DU.....	2
CEV410.....	9	CEV525C.....	3	CEV625EU.....	6
CEV413.....	55	CEV526.....	30	CEV625P1U.....	2
CEV416.....	55	CEV527.....	30	CEV625PU.....	6
CEV417.....	68	CEV530.....	9	CEV625T1U.....	2
CEV418.....	68	CEV531-2.....	19	CEV626-1.....	30
CEV419.....	68	CEV531T3U.....	19	CEV627I.....	30
CEV420.....	11	CEV532.....	19	CEV628-5N.....	46
CEV421.....	11	CEV532IU.....	18	CEV628-10.....	44
CEV423.....	55	CEV533-2.....	9	CEV628P5.....	41
CEV425.....	55	CEV535.....	33	CEV630-1A.....	51
CEV430.....	21	CEV538-10.....	24	CEV630C.....	51
CEV431-65.....	35	CEV538T5.....	23	CEV632-1A.....	49
CEV432.....	9	CEV538TU.....	22	CEV633-1A.....	51
CEV433.....	9	CEV540-5.....	23	CEV634-1A.....	49
CEV433-1.....	8	CEV540-10.....	24	CEV635-1.....	32
CEV433DU.....	6	CEV544.....	23	CEV636-1A.....	49
CEV433H.....	8	CEV544IU.....	22	CEV637I.....	49
CEV435-1.....	33	CEV560.....	38	CEV638T5NU.....	46
CEV435-2.....	33	CEV560-1.....	38	CEV640-10.....	24
CEV438.....	59	CEV565.....	38	CEV641DU.....	17
CEV438B.....	59	CEV566.....	38	CEV641FU.....	17
CEV438D5.....	59	CEV567.....	38	CEV641T1U.....	18
CEV440.....	60	CEV568.....	38	CEV642T1U.....	18
CEV440P6.....	60	CEV570.....	31	CEV642TFU.....	17
CEV442.....	25	CEV580-2.....	50	CEV643IU.....	17
CEV442E.....	25	CEV580-3.....	52	CEV646B5U.....	43, 48
CEV442Z.....	25	CEV601-1.....	20	CEV647B5U.....	43, 48
CEV443.....	54	CEV601P.....	20	CEV648B5U.....	43, 48
CEV444.....	69	CEV602-1.....	10	CEV649-10B.....	45
CEV445-5.....	25	CEV603I.....	39	CEV649B5U.....	43, 48
CEV445IU.....	25	CEV604T1U.....	26	CEV649BGPU.....	27
CEV448.....	60	CEV604T3U.....	26	CEV649C5U.....	27, 43, 48
CEV449.....	60	CEV605BGPU.....	27	CEV649G5.....	7
CEV449G.....	60	CEV605GPU.....	27	CEV649GPU.....	27
CEV453.....	55	CEV605GTU.....	26	CEV649M5.....	7
CEV453A.....	55	CEV605GU.....	26	CEV649P5.....	47
CEV455.....	60	CEV605T1U.....	26	CEV649T5BU.....	43, 48
CEV456.....	59	CEV605T3U.....	26	CEV649T5NU.....	46
CEV460U.....	5	CEV605T5U.....	26	CEV649X5.....	45
CEV470T1U.....	5	CEV606-1.....	14	CEV650T5D.....	23
CEV470U.....	3	CEV607CU.....	27	CEV650TU.....	22
CEV480.....	64	CEV607DU.....	27	CEV651-1.....	20
CEV500-A10.....	24	CEV607T1U.....	27	CEV652I.....	20
CEV500T5.....	23	CEV607U.....	27	CEV653-1.....	29
CEV500TU.....	22	CEV608-1.....	34	CEV658-10.....	44
CEV501.....	21	CEV608D.....	34	CEV660T1U.....	4
CEV501-2.....	21	CEV610-1.....	8	CEV661IU.....	4
CEV502.....	11	CEV611T1U.....	14	CEV662IU.....	4
CEV503.....	29	CEV612DU.....	16	CEV669B.....	49, 51
CEV504PS.....	85	CEV612T1U.....	14	CEV669BG.....	49, 51
CEV504S3.....	85	CEV613T1U.....	14	CEV670DU.....	6
CEV504S5.....	85	CEV614T1U.....	12	CEV670T1U.....	2
CEV505.....	33	CEV615T1U.....	12	CEV671T1U.....	4
CEV506.....	15	CEV616IU.....	16	CEV700T5.....	23
CEV507.....	9	CEV617IU.....	12	CEV700T5D.....	23
CEV508.....	35	CEV620T1U.....	12	CEV720.....	47
CEV511.....	15	CEV621T1U.....	10	CEV720B.....	47

CEV720BRUC.....	42	CEV1059-10B.....	44	CEV8649BGPU.....	27
CEV720RU.....	42	CEV2295A.....	53	CEV8649C5U.....	27, 43, 48
CEV721.....	11	CEV6285R.....	41	CEV8649GPU.....	27
CEV725.....	3	CEV6385RU.....	41	CEV8649P5.....	47
CEV728BR.....	44	CEV6795B.....	49, 51	CEV8649T5NU.....	46
CEV728BR5U.....	42	CEV7145A3.....	63	CEV8649T5TBU.....	43, 48
CEV728T5.....	41	CEV7145A5.....	63	CEV8649X5.....	45
CEV728T10.....	44	CEV7145A6.....	63	CEV8650TU.....	22
CEV738-5.....	23	CEV7145A7.....	63	CEV8660T1U.....	4
CEV738D5.....	23	CEV7145B6.....	63	CEV8670DU.....	6
CEV738T5.....	23	CEV7145B7.....	63	CEV8826L.....	62, 76
CEV740-5.....	23	CEV7285RU.....	42	CEV8826M.....	62, 76
CEV744T5.....	23	CEV7625I.....	7	CEV8826P.....	62, 76
CEV760.....	5	CEV7660I.....	7	CEV8826V.....	62, 76
CEV804.....	28	CEV8103D5.....	58	CEV9103D5.....	58
CEV805I.....	66	CEV8103G3.....	77	CEV9103G5.....	58
CEV815.....	3	CEV8103G5.....	58	CEV9104IU.....	26
CEV821G.....	11	CEV8104IU.....	26	CEV9107IU.....	69
CEV825.....	53	CEV8107IU.....	69	CEV9134BG.....	50
CEV830.....	52	CEV8126P.....	63	CEV9145A3.....	63
CEV834.....	50	CEV8126PM.....	63	CEV9145A5.....	63
CEV890.....	77	CEV8126V.....	63	CEV9145A6.....	63
CEV890C.....	77	CEV8143A3.....	61, 75	CEV9145A7.....	63
CEV891IU.....	79	CEV8143A4.....	61, 75	CEV9145B6.....	63
CEV891MU.....	80	CEV8143A7.....	61, 75	CEV9145B7.....	63
CEV892.....	81	CEV8143B7.....	61, 75	CEV9150A3.....	64
CEV893IU.....	79	CEV8145A3.....	63	CEV9150A4.....	64
CEV894IU.....	79	CEV8145A5.....	63	CEV9150A6.....	64
CEV894MU.....	80	CEV8145A6.....	63	CEV9150A7.....	64
CEV895IU.....	79	CEV8145A7.....	63	CEV9150B6.....	64
CEV895MU.....	80	CEV8145B6.....	63	CEV9150B7.....	64
CEV896.....	77	CEV8145B7.....	63	CEV9172A3.....	65
CEV896IU.....	79	CEV8407IU.....	4	CEV9172A4.....	65
CEV897.....	78	CEV8434I.....	8	CEV9172A6.....	65
CEV897BG.....	78	CEV8445IU.....	25	CEV9172A7.....	65
CEV897C.....	78	CEV8538TU.....	22	CEV9172B6.....	65
CEV898.....	77	CEV8544IU.....	22	CEV9172B7.....	65
CEV898IU.....	79	CEV8604T1U.....	26	CEV9229-1.....	53
CEV898L.....	77	CEV8605GTU.....	26	CEV9407IU.....	4
CEV899IU.....	79	CEV8605GU.....	26	CEV9445IU.....	25
CEV899U.....	80	CEV8605T1U.....	26	CEV9500TU.....	22
CEV904.....	28	CEV8607T1U.....	27	CEV9544IU.....	22
CEV915G.....	3	CEV8611T1U.....	14	CEV9604T1U.....	26
CEV965.....	23	CEV8612DU.....	16	CEV9605GTU.....	26
CEV980-3.....	56	CEV8613T1U.....	14	CEV9605GU.....	26
CEV980A.....	56	CEV8615T1U.....	12	CEV9605T1U.....	26
CEV980B.....	56	CEV8616IU.....	16	CEV9607T1U.....	27
CEV984.....	56	CEV8621T1U.....	10	CEV9611T1U.....	14
CEV985.....	56	CEV8623T1U.....	26	CEV9612DU.....	16
CEV992.....	81	CEV8624IU.....	12	CEV9614T1U.....	12
CEV992B.....	72	CEV8625CU.....	2	CEV9615T1U.....	12
CEV992C.....	72	CEV8625DU.....	2	CEV9617IU.....	12
CEV992D.....	81	CEV8625EU.....	6	CEV9620T1U.....	12
CEV995MU.....	81	CEV8625T1U.....	2	CEV9623T1U.....	26
CEV996MU.....	81	CEV8626I.....	30	CEV9624IU.....	12
CEV997MU.....	81	CEV8627I.....	30	CEV9625CU.....	2
CEV998MU.....	81	CEV8641T1U.....	18	CEV9625DU.....	2
CEV1019T5BU.....	40	CEV8642T1U.....	18	CEV9625T1U.....	2
CEV1019T5NUC.....	46	CEV8646B5U.....	43, 48	CEV9627I.....	30
CEV1039G5U.....	40	CEV8647B5U.....	43, 48	CEV9630-1A.....	51
CEV1039T5NU.....	46	CEV8648B5U.....	43, 48	CEV9634-1A.....	49
CEV1039T5TBU.....	40	CEV8649B5U.....	43, 48	CEV9641T1U.....	18

Integra MicroFrance® product reference number	Manufacturer part number equivalent
CM217S	CM217S
SM63	SM63
SM64	SM64
SM65	SM65



Integra MicroFrance SAS (France)
Le Pavillon ■ 03160 Saint Aubin le Monial ■ France



HEMODIA SAS
85, rue du Chêne Vert
31670 LABEGE ■ France



Swann Morton Ltd
Penn Works ■ Owlerton Green ■ Sheffield
South Yorkshire S6 2BJ ■ United Kingdom



Emergo Europe
Prinsessegracht 20
2514 AP ■ The Hague ■ The Netherlands

Availability of these products might vary from a given country or region to another, as a result of specific local regulatory approval or clearance requirements for sale in such country or region.

- Consult product labels and inserts for any indications, contraindications, hazards, warnings, precautions, and instructions for use.
- Non contractual document. The manufacturer reserves the right, without prior notice, to modify the products in order to improve their quality.
- Warning: Applicable laws restrict these products to sale by or on the order of a physician.

Additional information for EMEA Customers only :

Products mentioned in this document are CE class I, IIa or IIb devices. Contact Integra should you need any additional information on devices classification. All the medical devices mentioned on this document are CE marked in accordance with the applicable European laws, unless specifically identified as "NOT CE MARKED".

References that are not medical devices are identified with the indication "NOT A MEDICAL DEVICE".

Products marked with the symbol [®] are distributed by Integra MicroFrance SAS (France)

Date of last revision : 04/2023

For more information, please contact customer service :

Europe, Middle-East, Africa

International: +33 (0) 437 47 59 50 ■ +33 (0) 437 47 59 25 (Fax) ■ csemea@integralife.com
France: +33 (0) 437 47 59 10 ■ +33 (0) 437 47 59 29 (Fax) ■ custservfrance@integralife.com
United Kingdom: +44 (0) 1264 312 725 ■ +44 (0) 1264 312 821 (Fax) ■ custsvcs.uk@integralife.com
Belgium & Luxembourg: +32 (0)2 257 4130 ■ +32 (0)2 253 2466 (Fax) ■ custsvcbenelux@integralife.com
Netherlands: +31(0) 852 083 167 ■ +31(0) 207 093 627 (Fax) ■ custsvcnetherlands@integralife.com
Italy: +39 (0)2 577 8921 ■ +39 (0)2 575 113 71 (Fax) ■ custsvcityaly@integralife.com
integralife.eu/contact

Integra and the Integra logo are registered trademarks of Integra LifeSciences Corporation or its subsidiaries in the United States and/or other countries.

MicroFrance is a trademark of Integra LifeSciences Corporation or its subsidiaries.

All other trademarks and product names are the property of their respective owners.

© 2023 Integra LifeSciences Corporation. All rights reserved.

0328572-5-EN

DOCUMENT FOR USE IN EUROPE, MIDDLE-EAST AND AFRICA ONLY.