

**Integra<sup>®</sup> MicroFrance<sup>®</sup>**  
Catalogue Integra ORL - Cou

<b>Table des matières</b>	ii	<b>Couteau à végétations</b>	14
<b>Service Client et Garanties</b>	vi	A panier	14
<b>Indications / Contre-indications</b>	vii	Sans panier	14
<b>Consultation</b>	2	Couteau à végétations	14
Abaisse-langue	2	<b>Serre-noeud, amygdalotome</b>	15
<b>Ouvre-bouche de Kilner</b>	3	Amygdalotome lame	15
Cadre ouvre-bouche	3	Amygdalotome poignée	15
Abaisse-langue pour ouvre-bouche	3	Serre-noeud	15
Lave voute palatine	3	Anse fil d'acier	15
Protège-dents	3	Fil d'acier inox	15
<b>Ouvre-bouche de Davis-Boyle</b>	4	<b>Chirurgie cervicale</b>	16
Cadre ouvre-bouche	4	Cisaille	16
Abaisse-langue pour ouvre-bouche	4	Ciseaux en «S»	16
<b>Ouvre-bouche complet</b>	5-6	Crochet	16
<b>Ouvre-bouche de Morinière</b>	7	Dilatateur	16
Présentation de l'ouvre-bouche	7	Dissecteur	16
Composition de l'ouvre-bouche	8	Pince à disséquer le nerf facial	16
Set Instruments complémentaires	9	Sonde	16
<b>Abaisse-langue</b>	10	<b>Micro chirurgie</b>	17
Abaisse-langue aspirateur à panier	10	Micro canule à irrigation	17
Abaisse-langue double à panier	10	Micro clamp vasculaire	17
<b>Pince à amygdales végétations</b>	11	Micro pince à disséquer	17
Pince à griffes	11	Pince de joaillier	17
Pince à végétations	11	Micro porte-aiguille	18
Pince hémostatique à amygdales	11	Micro ciseaux	18
<b>Instruments à amygdales végétations</b>	12	Tapis silicone	18
Bistouri courbe pointe mousse	12	<b>Aspirateur à soupape</b>	19
Curette droite	12	Micro aspirateur irrigateur à soupape	19
Décolleur aspirateur cranté	12	Jankowski	19
Décolleur double	12	Lempert	19
Décolleur et écarteur	12	Wertheimer	19
Décolleur et Peigne	12	<b>Décolleur - rugine</b>	20
Décolleur et Peigne aspirateur monopolaire	12	<b>Bistouri - Scalpel</b>	21
Manche de bistouri	12	Manche de bistouri	21
Micro pointe monopolaire	12	<b>Rugine courbe</b>	22
Câble monopolaire	12	<b>Autres rugines</b>	23
Décolleur courbe cranté	13	Rugine droite	23
		Rugine courbe	23
		Rugine courbe tranchante	23
		<b>Ecarteur</b>	24
		Crochet pointu	24
		Ecarteur double	24
		Ecarteur mousse	24, 25
		Ecarteur pointu articulé	24
		Ecarteur pointu	25

<b>Ecarteur autostatique grand modèle</b>	26	<b>Pince à disséquer monopolaire moyenne</b>	46
<b>Ecarteur autostatique articulé</b>	27	Pince Adson	46
<b>Lame malléable écarteur - Ecarteur double</b>	28	Pince mors lisses	46
<b>Ecarteur mousse - Ecarteur double</b>	29	Pince mors striés	46
Ecarteur double en «S»	29	Pince mors à griffes	46
Ecarteur mousse 2 griffes	29	Câble monopolaire	46
Ecarteur mousse 4 griffes	29	<b>Pince à disséquer monopolaire longue</b>	47
<b>Ciseaux pointus courts, finition mat</b>	30	Pince mors coudés	47
<b>Ciseaux pointus longs</b>	31	Pince mors lisses	47
<b>Ciseaux mousses courts, finition mat</b>	32	Câble monopolaire	47
<b>Ciseaux mousses courbes longs</b>	33	<b>Porte-aiguille mors tungstène</b>	48
<b>Ciseaux de Metzenbaum petits, finition mat</b>	34	<b>Porte-aiguille mors tungstène long</b>	49
<b>Ciseaux de Metzenbaum longs</b>	35	<b>Pince hémostatique fine</b>	50
<b>Ciseaux de Mayo, finition mat</b>	36	<b>Pince hémostatique moyenne</b>	51
<b>Pince à disséquer fine</b>	37	<b>Pince hémostatique striée</b>	52
Pince à griffes et plateaux	37	Pince à griffes en "T"	52
Pince mors striés	37	Pince hémostatique striée	52
Pince mors à griffes	37	<b>Pince à préhension</b>	53
<b>Pince à disséquer Adson</b>	38	Pince à griffes	53
<b>Pince à disséquer moyenne</b>	39-40	Pince hémostatique fenêtrée	53
Pince à griffes et plateaux	39-40	<b>Oesophagoscopie</b>	54
Pince mors striés	39-40	Oesophagoscope	54
Pince mors à griffes	39-40	Fibre à lumière froide	54
<b>Pince à disséquer 180mm</b>	41	Poignée pour tube oesophagoscope	54
<b>Pince à disséquer 200mm</b>	42	Aspirateur boutonné à crépine	54
<b>Pince à disséquer bipolaire moyenne</b>	43	Micro pince	54
Pince mors à griffes	43	<b>Hypopharyngoscopie</b>	55
Pince mors lisses	43	Hypopharyngoscope	55
Pince mors striés	43	Fibre à lumière froide	55
Câble bipolaire	43	Aspirateur boutonné à crépine	55
<b>Pince à disséquer bipolaire 200mm</b>	44	Micro pinces	55
Pince mors lisses	44	<b>Diverticuloscopie</b>	56
Pince mors coudés	44	Diverticuloscope	56
Câble bipolaire	44	Aspiration pour diverticulospé	56
<b>Pince bipolaire avec irrigation</b>	45	Fibre à lumière froide	56
Pince mors fenêtrés	45	Aspirateur boutonné à crépine	56
Pince mors lisses	45	<b>Suspension - Lumière froide</b>	57
Pince mors striés	45	Bras de suspension appui thoracique débrayable	57
Câble bipolaire	45	Plaque pour bras de suspension	57
		Cavalier pour tablette	57
		Câble à lumière froide	57
		Raccords câble Lumière froide	57

<b>Laryngoscope ouvert</b>	58	<b>Micro coagulation</b>	69
<b>Laryngoscope sans aspiration</b>	59	Aspirateur à soupape monopolaire	69
<b>Laryngoscope avec aspiration</b>	60	Micro pinces bipolaires	69
<b>Laryngoscope de Sataloff</b>	61	Micro pointe baïonnette monopolaire	69
<b>Micro aspirateur</b>	62	<b>Injection laryngée</b>	70
Aspirateur boutonné à crépine	62	Injection laryngée transcervicale de Casiano Pistolet pour injection	70
Aspirateur de Sataloff	62	Raccord luer-lock	70
Aspirateur double	62	Aiguille à injection en baïonnette	70
Aspirateur gainé à soupape	62	<b>Instruments de Sataloff</b>	71
Aspirateur raccord olivaire	62	Aiguilles à injection	71
<b>Instruments de Bouchayer</b>	63	Micro Bistouri	71
Pince mors curettes	63	Micro crochet mousse	71
Pince mors curettes mors ovales	63	Micro curette à kyste	71
Pince mors en coeur	63	Micro décolleur	71
Pince mors striés	63	Micro écarteur	71
<b>Instruments de Bouchayer, longueur utile 220mm</b>	64	Miroir	71
Bistouri lancéolé démontable	64	Micro palpateur	71
Décolleur coudé 90°	64	Poignée porte instrument	71
Décolleur courbe	64	Porte-coton	71
Micro ciseaux laryngés	64	Pince mors curettes	72
Micro pince écarteur	64	Pince mors en cœur	72
Micro porte-aiguille	64	Pince mors striés	72
<b>Instruments de Pérouse, longueur utile 220mm</b>	65	<b>Instruments de Sataloff, Chirurgie indirecte</b>	73
Bistouri lancéolé démontable	65	Aiguille à injection	73
Décolleur coudé 90°	65	Dilatateur laryngé	73
Décolleur courbe	65	Micro aspirateur	73
Micro porte-aiguille démontable	65	Micro bistouri	73
<b>Instruments de Abitbol</b>	66	Micro ciseaux	73
Micro aspirateur gainé à soupape	66	Micro faux	73
Pince monopolaire et aspirante	66	Micro pince	73
<b>Autres instruments laryngés</b>	67	Poignée porte-instrument	73
Bistouri	67	Container	73
Crochet	67	<b>Instruments de Benninger</b>	74
Ecarteur	67	Ciseaux	74
Micro faux	67	Pince mors curettes	74
Manche de bistouri pour diastème laryngé	67	Pince mors en coeur	74
Lames de bistouri	67	Pince mors striés	74
Porte-aiguille	67	Porte-aiguille	74
Aiguille à injection	68	Pousse-noeud	74
Ciseaux	68	<b>Set d'Henry - 3.0mm</b>	75
Micro bistouri et micro faux avec poignée	68	Ciseaux	75
Micro canule à irrigation	68	Crochet monopolaire	75
Sonde double	68	Palpateur	75
Manche de bistouri non stérile	68	Pince mors fenêtrés	75
		Pince mors striés alligator	75
		Trocart	75
		Bague de fixation pour trocart	75

<b>Set de Terris, Chirurgie de la thyroïde</b>	76
Aspirateur malléable à soupape et crépine	76
Décolleur aspirateur malléable	76
Décolleur courbe	76
Ecarteur double	76
Porte-boule de coton	76
<b>Instrumentation mini invasive Ø 3,5mm</b>	77
Trocart métal à valve silicone	77
Trocart métal à valve aimantée	77
<b>Instrumentation pédiatrique Ø 3,5mm</b>	78-86
Trocart composite à valve silicone	78
Aspirateur irrigateur	79
Bistouri à lame rétractable	79
Crochets monopolaires	79
Pince bipolaire	80
Semi-démontable : Insert mors avec tube gainé	81
Raccord pour lavage insert tube	81
Poignée revolver	82
Poignée axiale	83
Poignée ergonomique	84
Ciseaux complets	85
Pince complète	85
Instruments de De Lagausie	86
Porte-aiguille	86
<b>Cupule, Plateau inox</b>	87
<b>Panier inox</b>	88
<b>Panier plastique</b>	89
<b>Panier plastique grande taille</b>	90
<b>Index numérique</b>	91
<b>Tableau d'équivalence à titre informatif</b>	99

## Garantie limitée d'Integra

Pour connaître les garanties applicables, merci de vous référer aux garanties précisées dans l'emballage de chaque produit.

## Contacts Services Clients :

### International

+33 (0) 4 37 47 59 50  
+33 (0) 4 37 47 59 25 (fax)  
csemea@integralife.com

### France

+33 (0) 4 37 47 59 10  
+33 (0) 4 37 47 59 29 (Fax)  
custservfrance@integralife.com

### Belgique & Luxembourg

+32 (0) 2 257 4130  
+32 (0) 2 253 2466 (Fax)  
custsvcbenlux@integralife.com

### Royaume-Uni

+44 (0) 1264 312 725  
+44 (0) 1264 312 821 (Fax)  
custsvcs.uk@integralife.com

### Pays-Bas

+31 (0) 852 083 167  
+31 (0) 207 093 627 (Fax)  
custsvcnetherlands@integralife.com

### Italie

+39 (0) 2 577 8921  
+39 (0) 2 575 113 71 (Fax)  
custsvitaly@integralife.com

## Instrumentation O.R.L. MicroFrance®

### INDICATIONS

- Tous les dispositifs médicaux présentés dans ce catalogue sont indiqués pour les consultations ORL et/ou la chirurgie ORL.
- Les dimensions présentes dans ce document ne sont pas contractuelles et sont données à titre indicatif seulement.

### CONTRE-INDICATIONS

- Ne pas utiliser dans d'autres indications que celles prévues (mentionnées) dans la notice d'instruction ou l'étiquetage.

Explications sur la présentation de ce catalogue

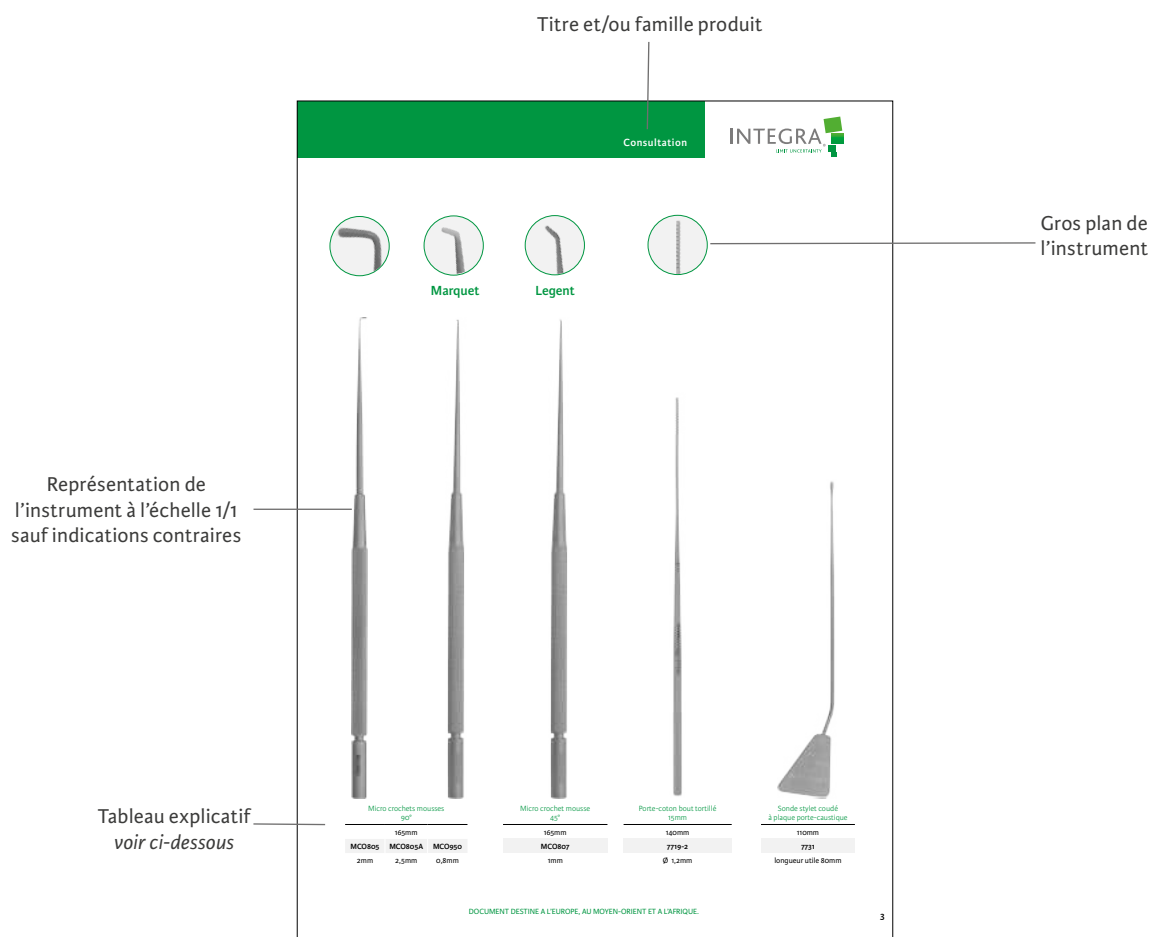

Explications sur le tableau référence produit et description complémentaire

Titre ou sous titre	
description complémentaire globale	
Réf. produit1	description complémentaire1
Réf. produit2	description complémentaire2

**Abaisse-langue**

**Doyen**

**Doyen**

**Canuyt**



Double

150mm - Boîte 10

7798T<sup>(D)\*</sup>

Double

150mm - Boîte 10

7798T1<sup>(D)\*</sup>

Abaisse-langue fenêtré

185mm

7796

<sup>(D)</sup> Distribué par Integra MicroFrance SAS (France) - Voir tableau d'équivalence annexe pour la référence du fabricant correspondante.  
\* Veuillez vérifier auprès de votre représentant commercial la disponibilité de ce produit dans votre pays.



Echelle 2/3



**Kilner**

Abaisse-langue fenêtré

7803S-3	7803S-2	7803S-1
40x75mm n°3	35x70mm n°2	30x60mm n°1



**Kilner**

Cadre

7803C



Lame voute palatine

7803B

sans fixation mâchoire supérieure  
spéciale lame voute palatine



Protège-dents Camo®

7960T40<sup>(D)</sup>\*

Boîte 40 - usage unique



**Chabolle**

Abaisse-langue fenêtré

MCR3A	MCR2A
40x90mm n°3	40x80mm n°2



Protège-dents silicone

7802P

Boîte 2

<sup>(D)</sup> Distribué par Integra MicroFrance SAS (France) - Voir tableau d'équivalence annexe pour la référence du fabricant correspondante.  
\* Veuillez vérifier auprès de votre représentant commercial la disponibilité de ce produit dans votre pays.



**Davis-Boyle**

Cadre  
7802C



Protège-dents Camo®

7960T40<sup>(D)</sup>\*

Boîte 40 - usage unique



Protège-dents  
silicone

7802P

Boîte 2



**Davis-Boyle**

Abaisse-langue aspirateur

7802S-5	7802S-4	7802S-3	7802S-2	7802S-1
20x105mm n°5	25x90mm n°4	25x75mm n°3	25x60mm n°2	20x25mm n°1

<sup>(D)</sup> Distribué par Integra MicroFrance SAS (France) - Voir tableau d'équivalence annexe pour la référence du fabricant correspondante.  
\* Veuillez vérifier auprès de votre représentant commercial la disponibilité de ce produit dans votre pays.

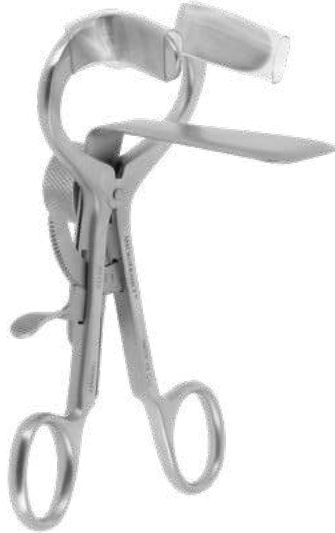

**Masson**

7809MF

140mm



**Doyen**

7821B

7821A

120mm

140mm

7821B

Echelle 1/2

**Seemann-Seiffert**

7805-11	7805-13
110mm	130mm



7805-11

**Jennings**

7804-9	90mm
7804-11	110mm
7804-13	130mm

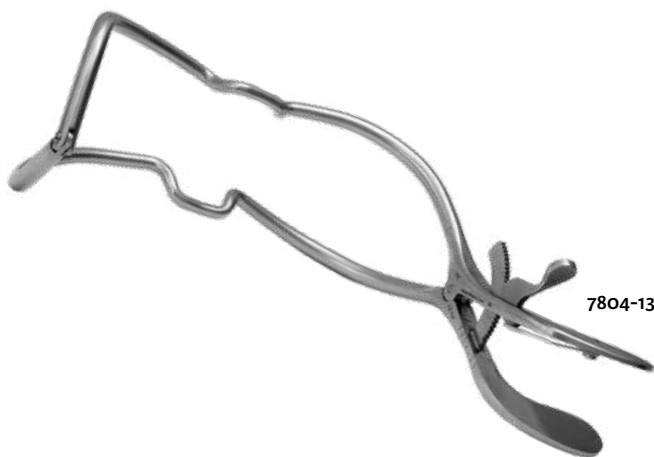

7804-13

Présentation de l'ouvre-bouche pour chirurgie mini invasive endoscopique

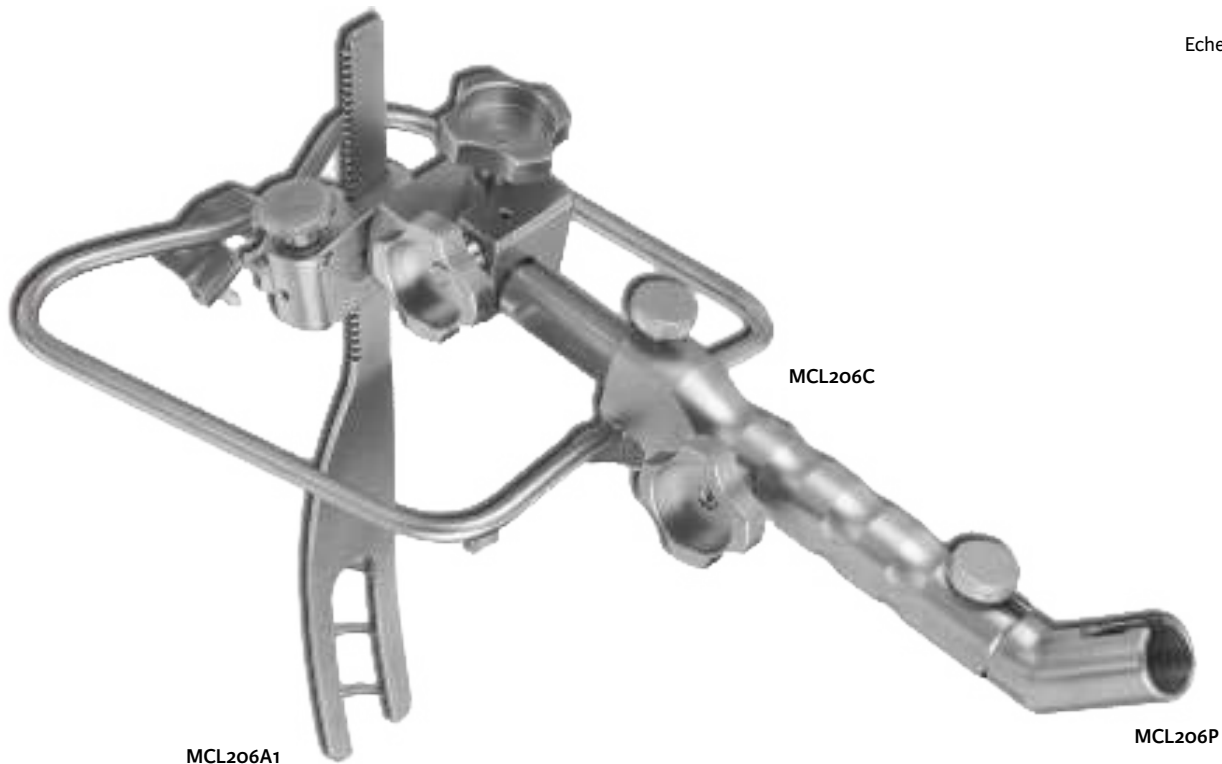
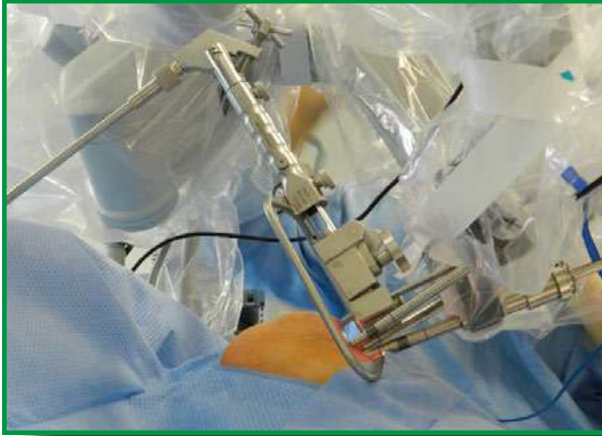

Echelle 1/2

MCL206A1

MCL206C

MCL206P

Cadre MCL206C  
avec abaisse-langue MCL206A1  
et pièce intermédiaire MCL206P

Composition de l'ouvre-bouche

Echelle 1/3

MCL206

Ouvre-bouche complet pour chirurgie mini-invasive composé d'un cadre, 5 abaisse-langues, une clé de serrage et une pièce coudée

Cadre

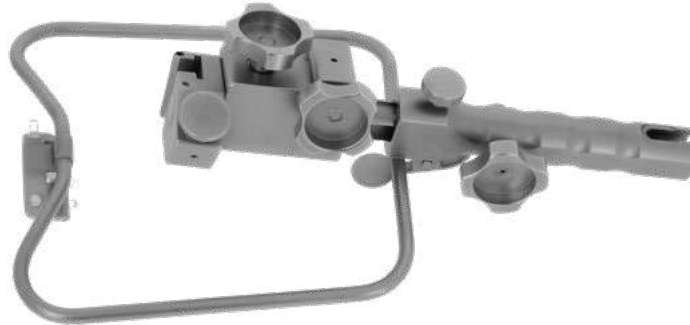

MCL206C

Abaisse-langue

MCL206A1 35x120mm fenêtré



MCL206A2 35x120mm



MCL206A3 35x110mm



MCL206A4 40x85mm



MCL206A5 35x65mm



Clé de serrage

Pièce intermédiaire

MCL206K



MCL206P



Accessoires complémentaires, non inclus dans la réf. MCL206

MCL206A6 laryngoscope 140x20mm



MCL206A7 diverticuloscope 180x23mm



## Instruments complémentaires

Photos à titre indicatif, sans échelle

### Protège-dents

**7802P** Protège-dents (Pk 2)

**7960T40<sup>(D)</sup>\*** Protège-dents - (Pk 40)  
Usage unique



### Lumière froide

**MCL38N<sup>(D)</sup>\*** Câble à lumière froide 2200mm

#### Raccords

**MCL170<sup>(D)(1)\*</sup>**

**MCL171<sup>(D)(1)\*</sup>**

**MCL173<sup>(D)(1)\*</sup>**

**MCL174<sup>(D)(1)\*</sup>**

**MCL197<sup>(D)(1)\*</sup>**

**Wolf**

**Storz**

**Olympus**



<sup>(1)</sup> Produit non dispositif médical

### Fibre à lumière froide

**MCL89-2** Fibre à lumière froide



### Suspension

**MCL76** Bras de Suspension

**MCL35** Plaque



### Aspirateurs

**MCL89-1** Aspirateur raccord olivaire

**MCL100** Aspirateur boutoné

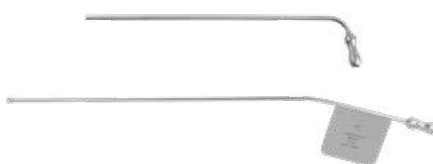

### Container

**7874MF-34** Container 380x205x85mm  
340x200x80mm



### Tapis silicone

**MCM25-3** Tapis silicone

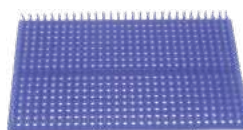

<sup>(D)</sup> Distribué par Integra MicroFrance SAS (France) - Voir tableau d'équivalence annexe pour la référence du fabricant correspondante.  
\* Veuillez vérifier auprès de votre représentant commercial la disponibilité de ce produit dans votre pays.

Portmann

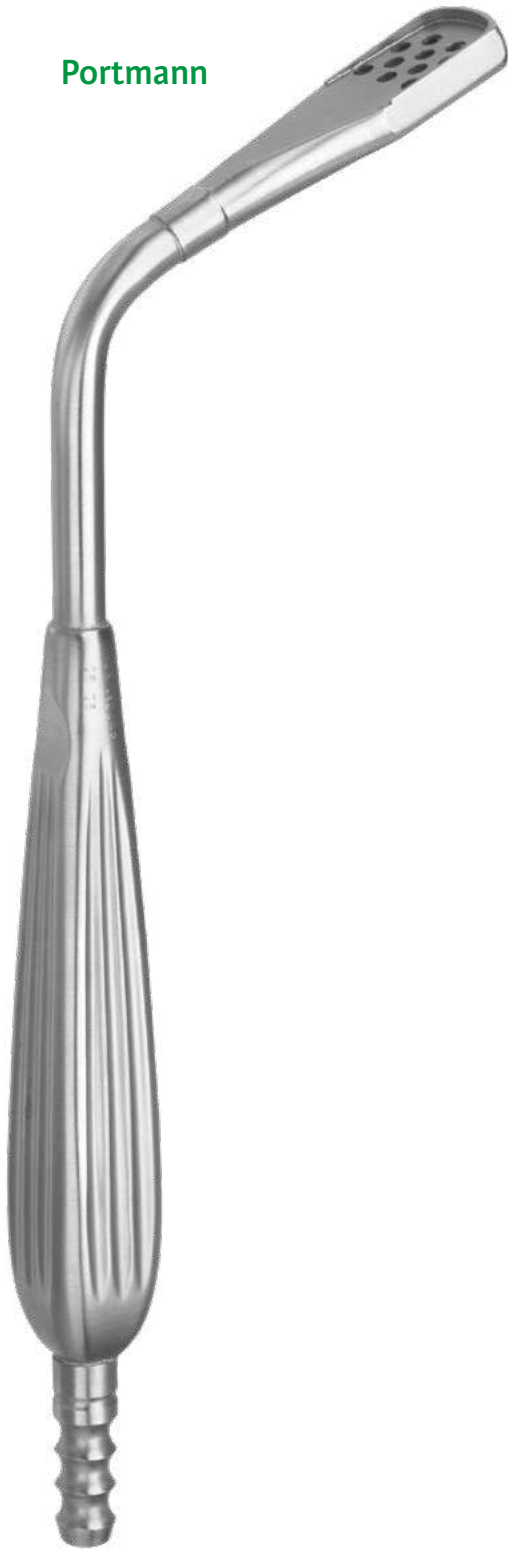

200mm

7857

Lecouteur



160mm

7800MF

Le Mée



7797-2

170mm

7797-1 Petit

7797-2 Grand



Echelle 1/2

**Birkett**



200mm  
7823

**Schmidt**



anneau ouvert

190mm  
7822

**Négus**



200mm  
7825

**Bourgeois**



200mm  
7819

**Portmann**



anneau ouvert

200mm  
7820

**Chatelier**

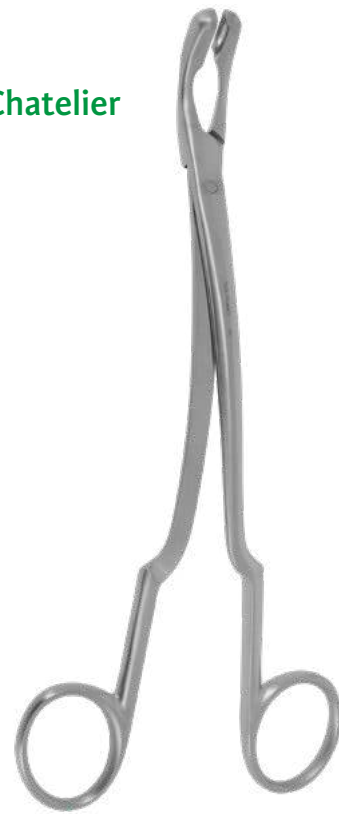

210mm  
7826-1-7

Echelle 1/2

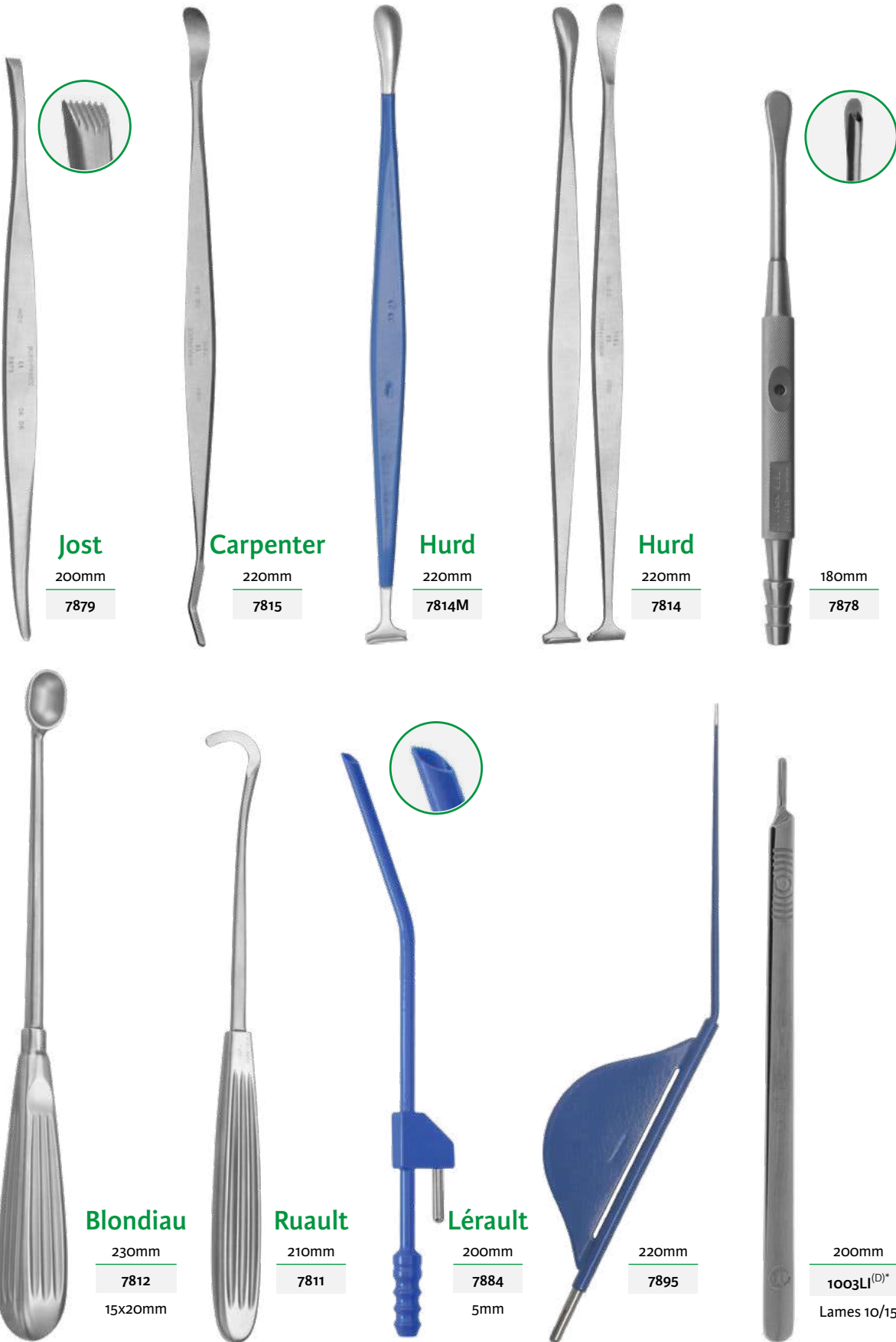

**Jost**  
200mm  
7879

**Carpenter**  
220mm  
7815

**Hurd**  
220mm  
7814M

**Hurd**  
220mm  
7814

180mm  
7878

**Blondiau**  
230mm  
7812  
15x20mm

**Ruault**  
210mm  
7811

**Lérault**  
200mm  
7884  
5mm

220mm  
7895

200mm  
1003LI<sup>(D)\*</sup>  
Lames 10/15

**Câbles monopolaires 3,5 m**

**CP391E**  
Erbe ACC ICC/VIO  
Storz Wolf

**CP391M**  
Aesculap Berchtold  
Lamidey  
Martin Erbe T Serie  
Sutter BM-780 II

**CP391V**  
Bowa Bovie  
Conmed Valleylab

<sup>(D)</sup> Distribué par Integra MicroFrance SAS (France) - Voir tableau d'équivalence annexe pour la référence du fabricant correspondante.  
\* Veuillez vérifier auprès de votre représentant commercial la disponibilité de ce produit dans votre pays.

Echelle 2/3

## Hurd

Décolleur  
225mm

3734042



Echelle 2/3

**Moure**



7828-1-13

220mm - sans panier

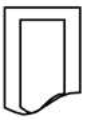

7828-1-10 6/10mm



7828-1-13 8/13mm

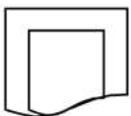

7828-1-16 10/16mm



7828-1-19 12/19mm

**Moure**



7828-16

220mm - à panier



7828-10 6/10mm

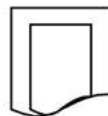

7828-13 8/13mm

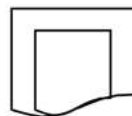

7828-16 10/16mm



7828-19 12/19mm

**Lermoyez**



7829-10

220mm - sans panier



7829-10 5/10mm

7829-13 7/13mm

7829-16 9/16mm

7829-19 13/19mm

Echelle 1/2

Longueur utile «L»

**Sluder**

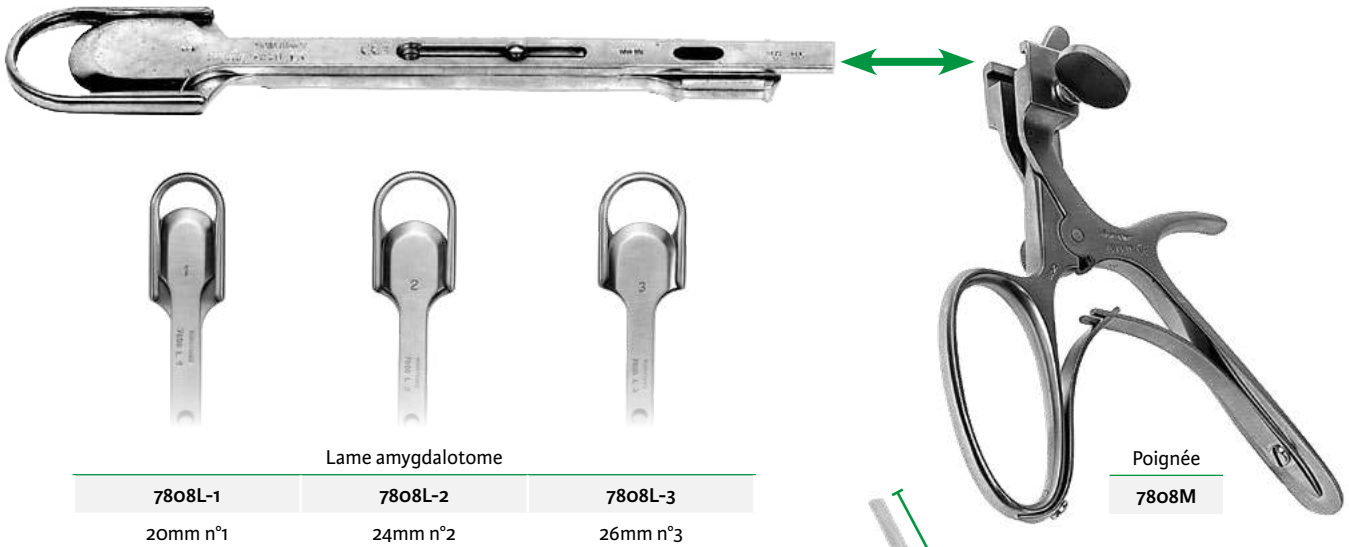

**Brünings**

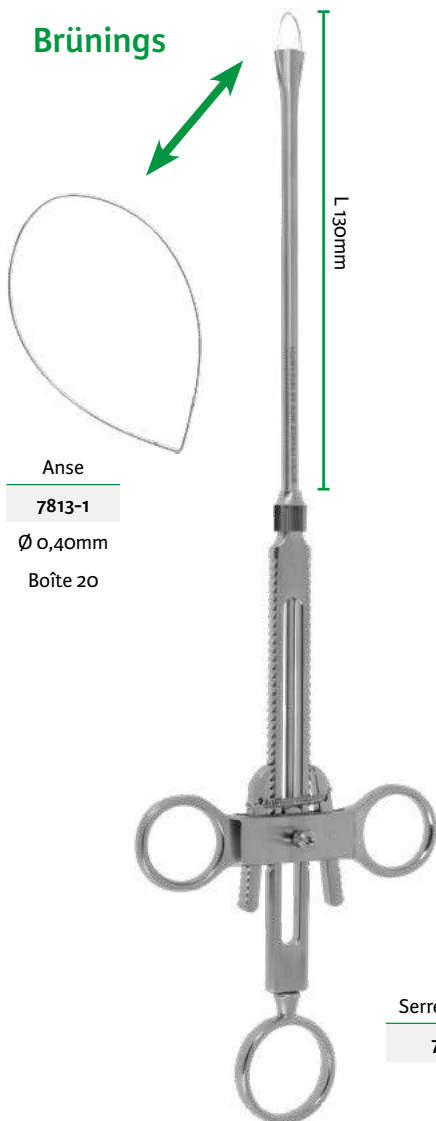

**Vacher**

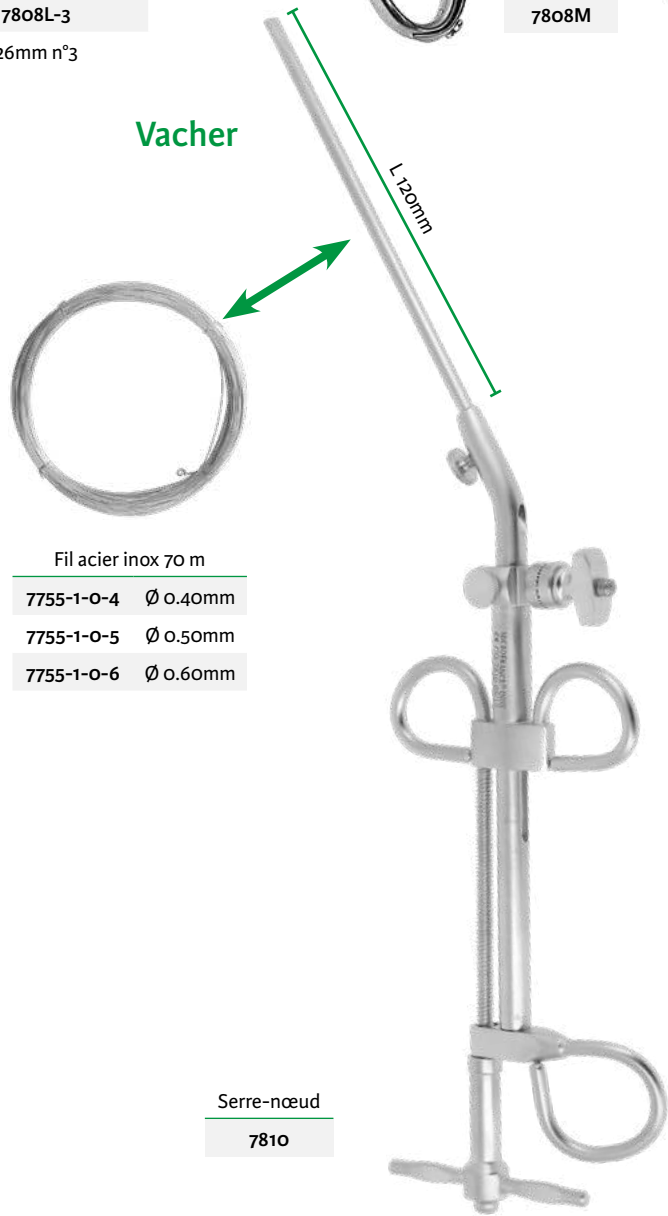

Echelle 1/2

**Laborde**



Dilatateur

7840  
120mm 80°

**Guerrier**



Crochet

7838  
180mm

**Marie**



Sonde

7839  
145mm



Pince à disséquer le nerf facial

7830M  
160mm

**Moure**



Cisaille lames crantées

7835  
200mm

**Guerrier**



Ciseaux en «S»

7921  
180mm

**O'Shaugnessy**



Dissecteur passe-fil

7837-18  
180mm

**Redon**



7920  
140mm

Longueur utile «L»

Micro canule à irrigation



MCM10-0-5	Ø 0,5mm	L 30mm
MCM10-1-0	Ø 1,0mm	

Micro clamp vasculaire L 13mm

**Gilbert O'Brien**

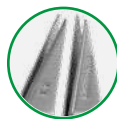

Moyen

MCM13

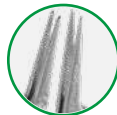

Petit

MCM13-1

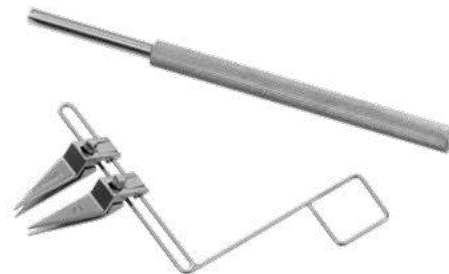

MCM13

Micro pince à disséquer - 150mm



MCM4BISR



MCM4BISR

Mors à griffes et plateaux

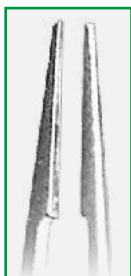

MCM4R

Mors lisses à plateaux

Pince de joaillier



130mm

MCM973D3 n°3

MCM973D5 n°5

Micro ciseaux

Vanas



**MCM7BISR**

8mm  
Courbes mouses

Vanas



**MCM7R**

8mm  
Droits crantés



**MCM970**

8mm  
Courbes atraumatiques



**MCM7BISR**  
150mm



**MCEN136SC**

290x175x55mm - 270x160x35mm

Micro porte-aiguille

O'Brien



**MCM12R**

5x0.3mm  
Mors lisses courbes

Barraquer-Comtet



**MCM1R**

8mm  
Mors lisses droits



**MCM12R**  
150mm

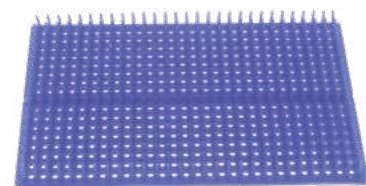

**MCM25-3**

210x130mm



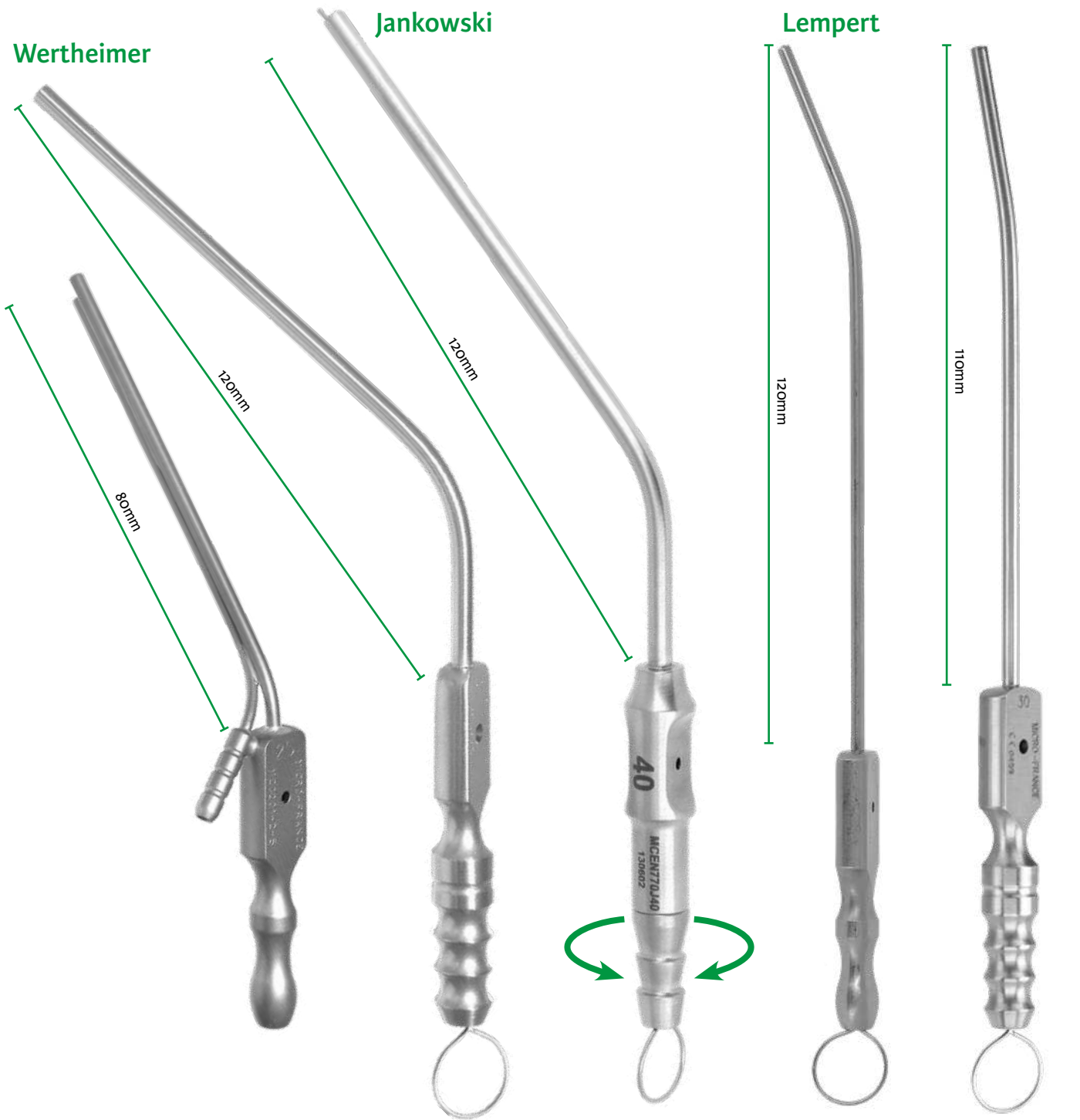

- 1,5mm
- 2mm
- 2,5mm
- 3mm
- 3,5mm
- 4mm

Wertheimer		Jankowski		Lempert	
MCO201-2-5	2,5mm	MCEN770J40	4mm	MCO771-2-5	2,5mm
MCO201-3-0	3mm	MCEN770J30	3mm	MCO771-3-0	3mm
MCO770-1-5	1,5mm			MCO771-4-0	4mm
MCO770-2-0	2mm				
MCO770-2-5	2,5mm				
MCO770-3-0	3mm				
MCO770-3-5	3,5mm				
MCO770-4-0	4mm				
				CP330-3-0	3mm
				CP330-4-0	4mm

Sébileau



190mm  
CP985  
5mm

Fleury



180mm  
MCO305  
8,5mm

Freer



160mm  
MCO803  
2,5mm

Howarth



185mm  
CP611  
5mm

Cottle



220mm  
CP625

McKenty



220mm  
CP626



240mm  
CP627



120mm

160mm

200mm

150mm

120mm

1003IG<sup>(D)\*</sup>

1005I<sup>(D)\*</sup>

1003LI<sup>(D)\*</sup>

CP821

1004IG<sup>(D)\*</sup>

N° 3

N° 7

N° 3L

N° 3

N° 4

Utilisation avec lames 11/15

lames 23

<sup>(D)</sup> Distribué par Integra MicroFrance SAS (France) - Voir tableau d'équivalence annexe pour la référence du fabricant correspondante.  
\* Veuillez vérifier auprès de votre représentant commercial la disponibilité de ce produit dans votre pays.

Farabeuf



150mm

7787-10

10mm

Fleury



170mm

MCO979

6,5mm

Sébileau



150mm

CP825

4mm

Plester



180mm

MCO988

7,5mm



195mm

3724059

6,5mm

Joseph

Obwegeser



180mm

**CP310**

5mm



180mm

**CP310D**

5mm  
droite



180mm

**CP310E**

4mm

CP310



Obwegeser

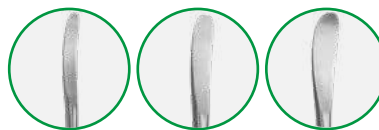

180mm

**CP344A**

5mm

**CP344B**

7mm

**CP344C**

11mm

Obwegeser-Tessier

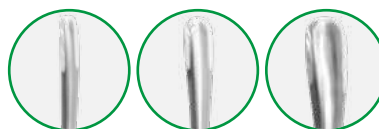

180mm - tranchante

**CP344AT**

5mm

**CP344BT**

7mm

**CP344CT**

11mm

Obwegeser



190mm

**CP344D**

7mm  
courbe

**CP344E**

7mm  
très courbe

Obwegeser-Tessier



190mm - tranchante

**CP344DT**

7mm  
courbe

**CP344ET**

7mm  
très courbe

CP344A

Farabeuf



140mm    120mm  
7768-1    7768  
la paire    la paire

Desmarres



140mm  
CP822-12  
12mm  
CP822-10  
10mm  
CP822-14  
14mm

Gillies



180mm  
CP17  
3mm  
CP17-1  
2mm

Gillies



145mm  
CP17-3  
2mm  
CP17-2  
3mm

Humby



110mm  
CP941  
articulé

Knapp



150mm

3714027

8mm

3714028

mousse



140mm

CP21-3

pointu

CP21A-3

mousse

Volkmann



150mm

7782-1-2



180mm

CP335

Senn-Miller



160mm

CP609

3 griffes pointues

## Weitlaner



Ecarteur courbe

160mm

0-28-7

griffes pointues



**Bizeau**

165mm

MCL359

valves 20x30mm



**Weitlaner-Beckmann**

165mm

7781



Malléable



210mm

CP818-8

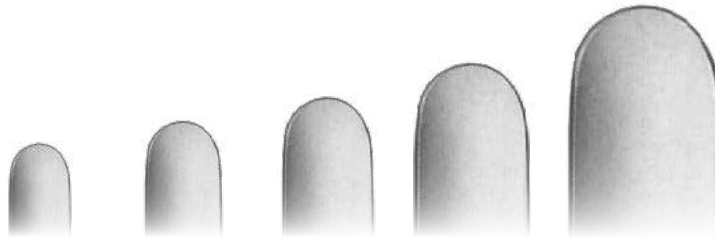

8mm

10mm

12mm

15mm

20mm

CP818-8

CP818-10

CP818-12

CP818-15

CP818-20

Dautrey



15x40mm

15x55mm

140mm

CP984

Dautrey



15x60mm

15x85mm

140mm

CP984-1

Malléable



10mm

15mm

Ecarteur à lambeaux  
10/15mm - 160mm

7773

Echelle 2/3



200mm

CEV418

Boîte 2



Descottes

200mm

CEV417

Boîte 2

Mosnier

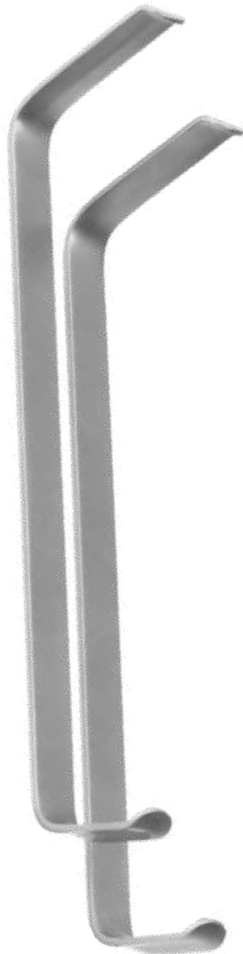

160mm

CEV419

Boîte 2

Pessey



180mm

CP335P

Leroux-Robert

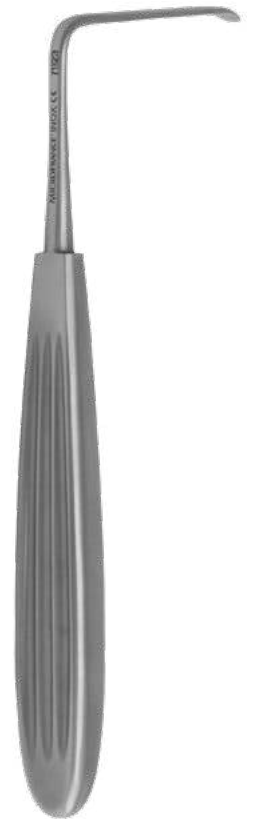

160mm

7923

Echelle 3/4

**Streiff**



CP16-1

105mm

CP16-1	CP16
lames courbes	lames droites

**Offret**



100mm

CP353
forte courbure



100mm

CP356
-------

**Joseph**



CP354A

120mm

CP354A	CP354
lames courbes	lames droites

**Joseph**



CP919A

110mm

CP919A	CP919
lames courbes	lames droites

**Fox**



CP358A

110mm

CP358A	CP358
lames courbes	lames droites

**Kilner-jost**



120mm
CP362
Courbe

**Boetcher**



180mm
CP997
Courbe

**Brophy**



150mm	
CP367-1	CP367
Courbe	Droit

**Joseph**



150mm	
CP355A	CP355
Courbe	Droit

Echelle 3/4

**Shea**



120mm

**CP637**

lames courbes

**Bregat**



110mm

**CP363**

lames courbes

**Stevens**



110mm

**CP922A**

lames courbes

**Stevens**



110mm

**CP922**

lames droites

**Stevens**



115mm

**CP922B**

lames courbes modèle «Angers»

Reynolds

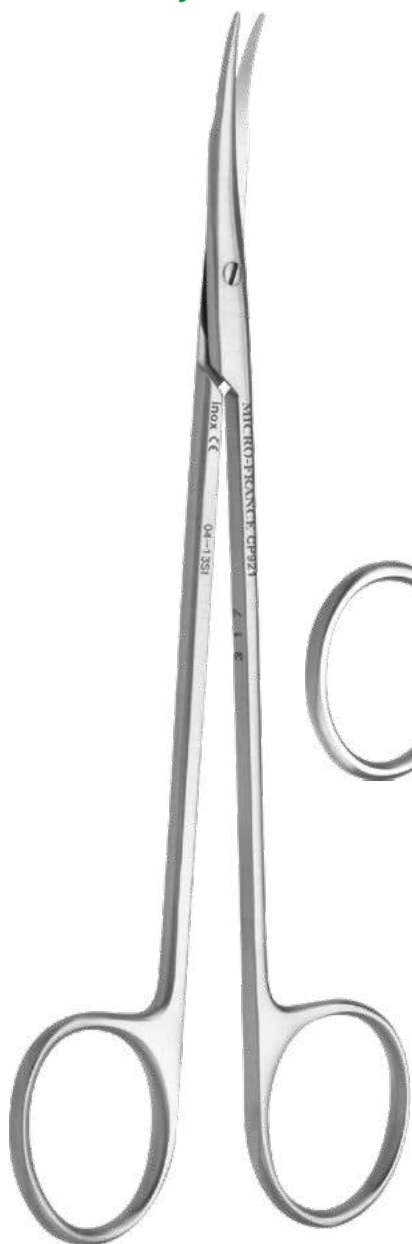

160mm

CP921

Ragnell



150mm

CP616-15



130mm

CP616-13

Joseph



140mm

CP355C

Léger



140mm

CP365



110mm

<b>CP351-7</b>	<b>CP351-6</b>
lames courbes	lames droites

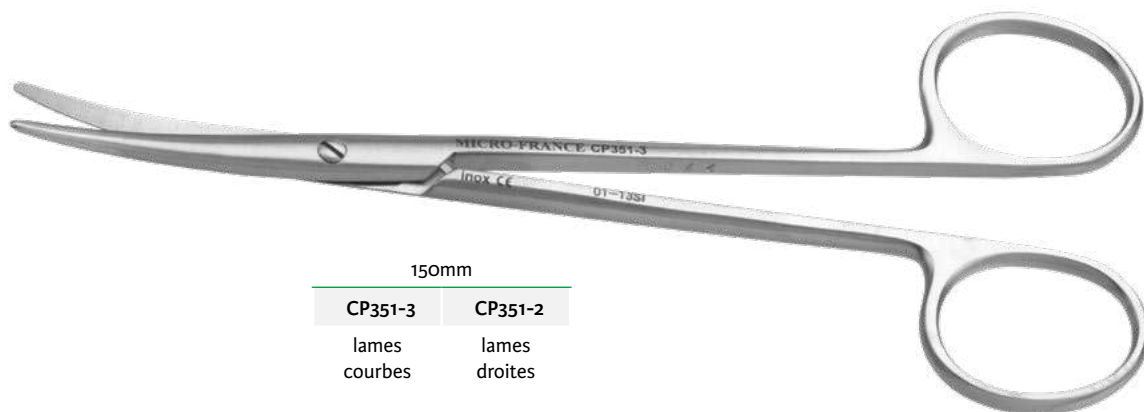

150mm

<b>CP351-3</b>	<b>CP351-2</b>
lames courbes	lames droites

## Lames Fines

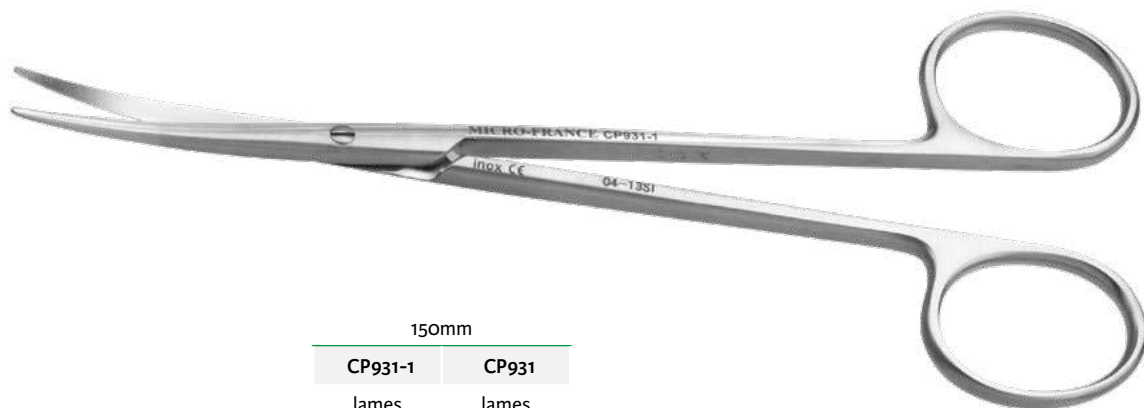

150mm

<b>CP931-1</b>	<b>CP931</b>
lames courbes	lames droites





CP351-5

Courbe standard

CP351-5	CP351-1
200mm	180mm



CP931-5

Courbe modèle fin

CP931-5	CP931-3
200mm	180mm



170mm  
CP352-2  
lames droites



150mm  
CP352  
lames droites



170mm  
CP352-3  
lames courbes



150mm  
CP352-1  
lames courbes

**Pince à disséquer 110mm**

Castroviejo

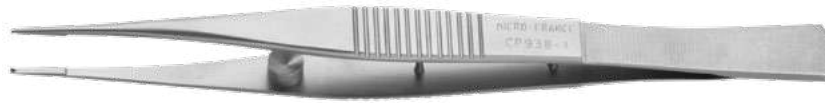

CP938-1

Griffes horizontales et plateaux lisses

Castroviejo



CP37

Griffes obliques et plateaux lisses



CP332

Mors striés croisés 1,4mm

**Pince à disséquer 120mm**



mors striés

CP414

Mors 1mm



7831A-12

Mors 1,5mm



mors à griffes

CP406

Mors 1mm



7833A-12

Mors 1,5mm



CP400-1

5x5 griffes

150mm

Adson



CP604-15 mors striés 1,5mm

CP605-15 mors à griffes 1,5mm

Adson-Brown



CP606-15 mors 7x7 griffes

120mm



Adson-Tubiana

Mors 1mm



Adson

Mors 1,5mm



Mors 1,5mm



Adson-Brown

Mors 7x7 griffes

M832 striés	M833 à griffes	CP604 striés	CP605 à griffes	CP606A striés tungstène	CP606
----------------	-------------------	-----------------	--------------------	----------------------------	-------

**Mac-Indoe**

140mm



CP934

Griffes obliques et plateaux striés

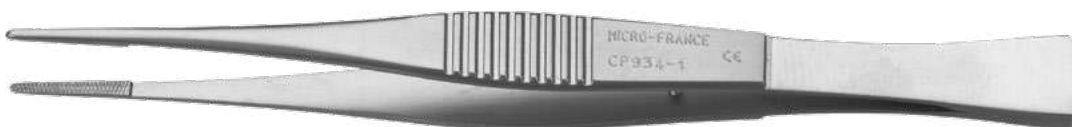

CP934-1

Plateaux striés

**Debakey**

**Barraya**

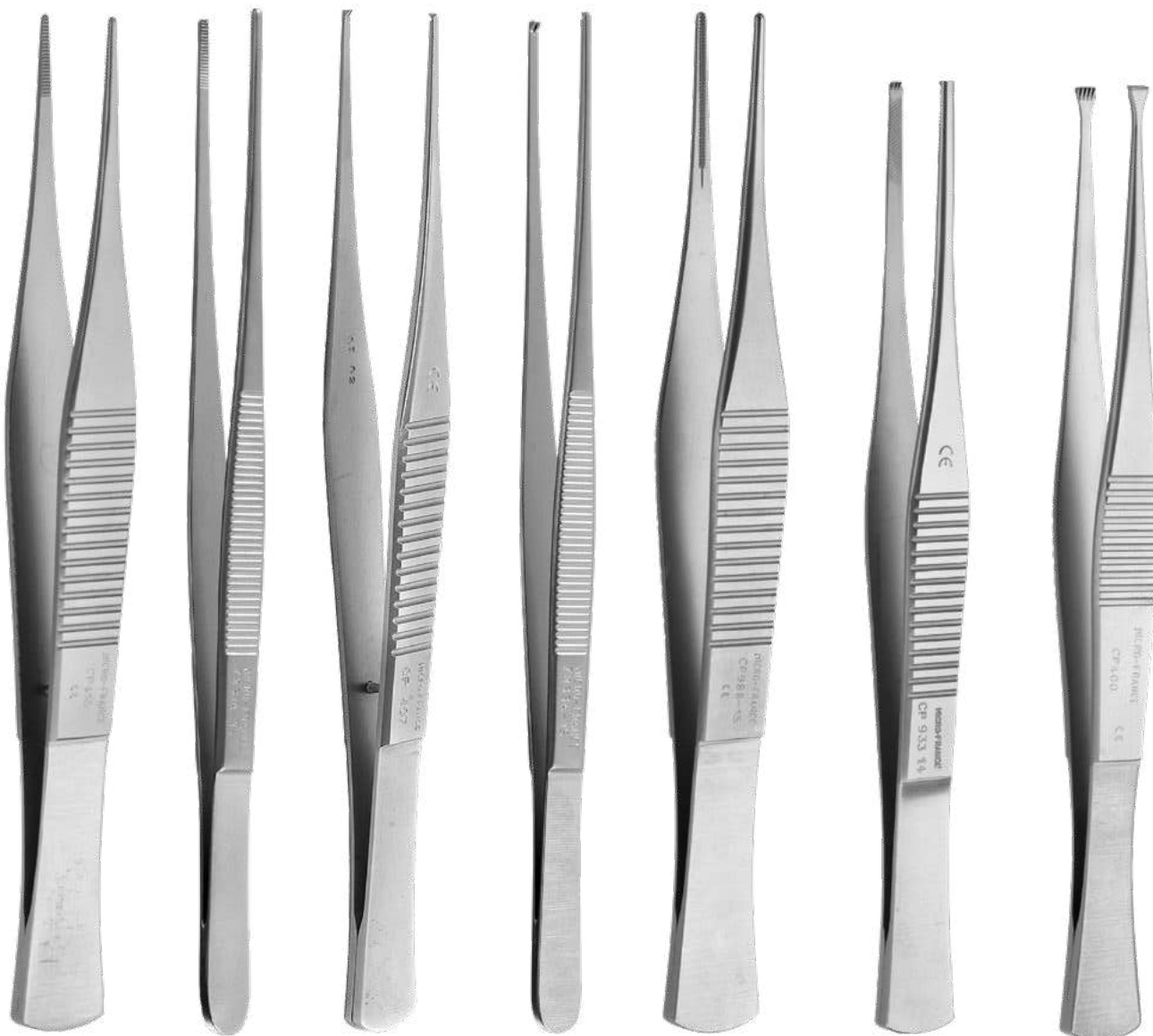

150mm

140mm

<b>CP415</b>	<b>7831A-15</b>	<b>CP407</b>	<b>7833A-15</b>	<b>CP988-15</b>	<b>CP933-14</b>	<b>CP400</b>
Mors striés 1mm	Mors striés 1,5mm	Mors à griffes 1mm	Mors à griffes 1,5mm	Mors 1,5mm	3x4 griffes et plateaux striés	Mors 5x5 griffes

Précelle



150mm

CP345

mors striés

Barraya



160mm

CP933-16

3x4 griffes  
et plateaux striés

Claoué



160mm

CP401

5x6 griffes

Mac-Indoe



170mm

CP936

1x2 griffes  
et plateaux striés

Debaquey



1,5mm  
7831A-18



1,5mm  
CP988-18



1mm  
CP409  
1x2



1,5mm  
7833A-18  
1x2

Barraya



1,5mm  
CP933-18  
3x4  
et plateaux striés



6x6  
CP400-2

Debakey



200mm

7832

1mm  
mors striés



210mm

7834

1mm  
1x2 griffes



2mm

7831A-20

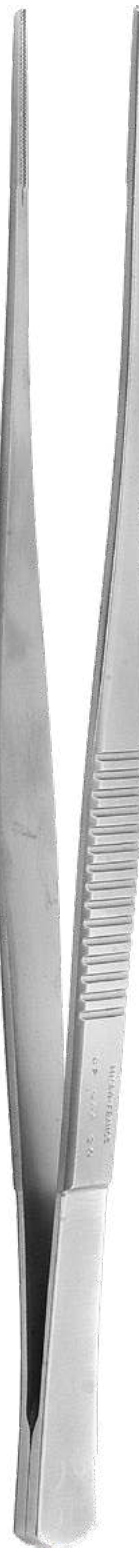

1,5mm

CP988-20



2mm

7833A-20

1X2



Câbles bipolaires - 4,5 m

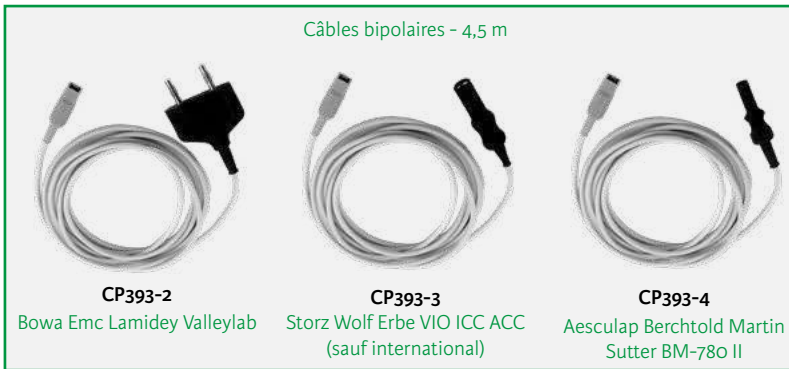

Magnan

Adson



110mm	120mm		160mm		200mm	
CP392-1R	CP604BR	CP605BR	CP392-2R	CP392-8R	CP392BI	CP392BS
Mors lisses 1x8mm	Mors striés 1,5mm	Mors à griffes 1,5mm	Mors lisses 1x8mm	Mors lisses 1x8mm	Mors lisses 0,5x5mm	Mors lisses 0,5x5mm



Câbles bipolaires - 4,5 m



**CP393-2**  
Bowa Emc Lamidey Valleylab



**CP393-3**  
Erbe VIO ICC ACC  
(sauf international)  
Storz Wolf



**CP393-4**  
Aesculap Berchtold Martin  
Sutter BM-78o II

CP392-3R	CP392-10R	CP392-5R	CP392-9R
Droite	Coudée	Baïonnette	Baïonnette
Mors lisses	Mors lisses	Mors lisses	Mors coudés
1x8mm	1x8mm	1x8mm	1x8mm

Dousset



300mm

CEV392D30

Mors 3mm

Belghiti



230mm

CEV392D20

Mors 2mm



230mm

CEV392P20

Mors 2mm



Soubrane



230mm

CEV392S20

Mors 2mm

Gayet



240mm

CEV392G24

Mors 5x15mm

Partenski



210mm

CEV392R15

Mors 4x10mm

Câbles bipolaires - 4,5 m

 <b>CP393-2</b> Bowa Emc Lamidey Valleylab	 <b>CP393-3</b> Storz Wolf Erbe VIO ICC ACC (sauf international)	 <b>CP393-4</b> Aesculap Berchtold Martin Sutter BM-780 II
---	---	---



**Adson**

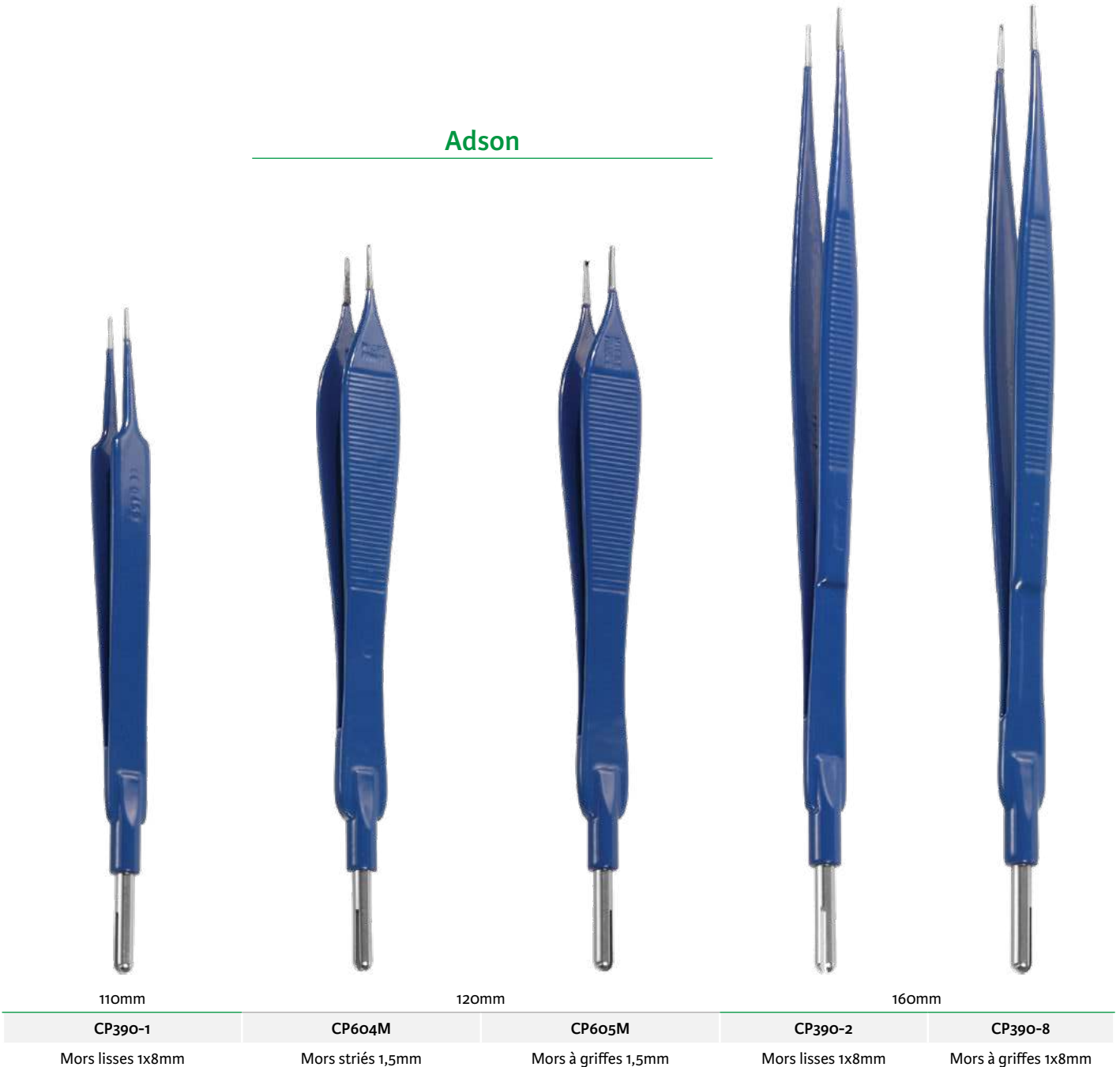

Echelle 2/3

Longueur utile - «L»

**Chambon**



290mm L 260mm

**CP390L26**

Mors lisses 1x8mm



**CP390-3**

Mors lisses 1x8mm



230mm L 200mm

**CP390-5**

Mors coudés 1x8mm



**CP390-7**

Mors lisses 1x8mm

Câbles monopolaires 3,5 m



**CP391E**

Erbe ACC ICC/VIO  
Storz Wolf



**CP391M**

Aesculap Berchtold Martin  
Erbe T Serie Lamidey  
Sutter BM-780 II



**CP391V**

Bowa Bovie Conmed Valleylab

**Halsey**

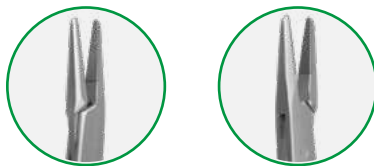

130mm

<b>703T</b>	<b>704T</b>
Mors striés	Mors lisses



703T

**Crile-Wood Mayo-Hégar**

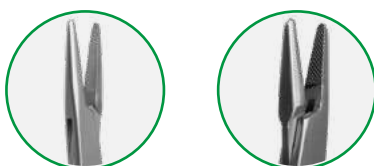

150mm

<b>702T</b>	<b>714T</b>
-------------	-------------



702T

**Becker**



130mm

**CP1107**

Mors diamantés

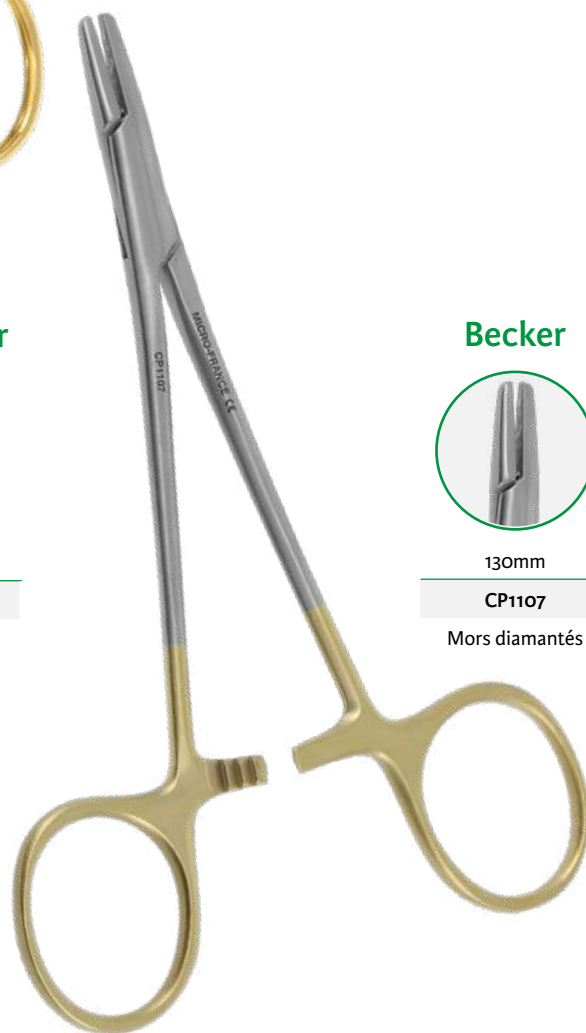

Echelle 2/3

Crile-Wood

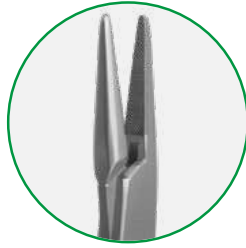

200mm

720T



Crile-Wood

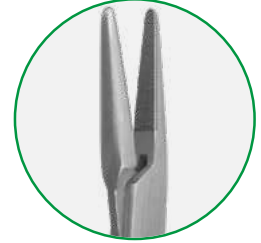

180mm

701T



Stratte



210mm

7945T

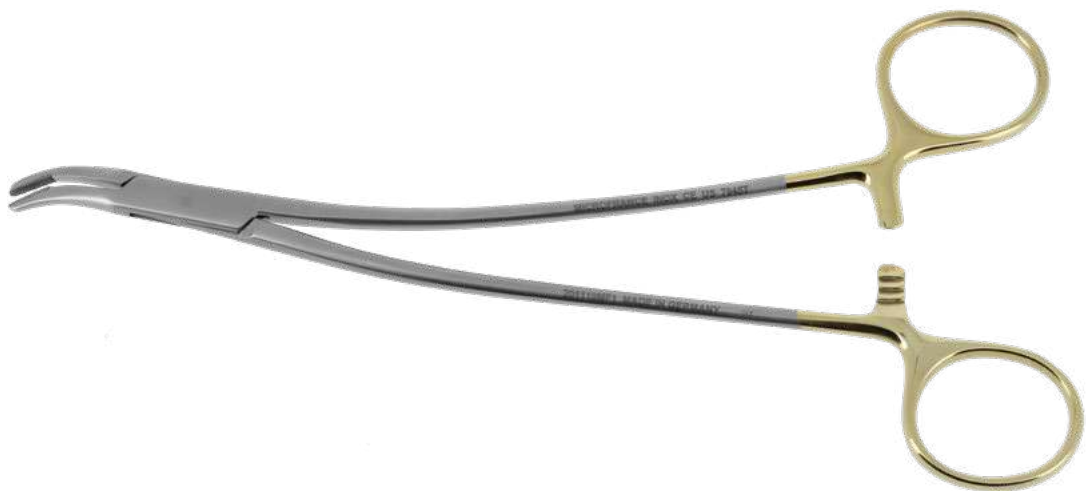

**Halsted**

120mm - à griffes

P761-7	P761-8
--------	--------

Droite	Courbe
--------	--------



P761-7

**Leriche**

140mm - sans griffe

7867-1	7867-2
--------	--------

Droite	Courbe
--------	--------

140mm - à griffes

7867-3	7867-4
--------	--------

Droite	Courbe
--------	--------



7867-1



### Kelly

Sans griffe

140mm	160mm
-------	-------

P762-2	P762-4
--------	--------

Courbe	Courbe
--------	--------



P762-2

### Kocher

140mm	160mm	180mm
-------	-------	-------

Droite sans griffe

P764-1	P764-5	-
--------	--------	---

Droite à griffes

P764-3	P764-7	P764-11
--------	--------	---------



P764-3



**Martel**

130mm

P763

Pince striée  
à griffes en «T»



**Terrier**

130mm

P769

Pince hémostatique  
mors striés



**Péan**

140mm 160mm

P765-14 P765-16

Pince hémostatique  
mors striés

P765-14



**Chaput**

130mm

7866-13

2x3 griffes



**Ombredanne**

Pince à griffes  
130mm

P771

Pince hémostatique  
fenêtrée  
160mm

P770

mors en cœur

**Aspirateur boutoné**

Echelle 1/4

Longueur utile - «L»

	2mm	2,5mm	3mm	3,5mm	4mm
L 450mm	MCL920L45	MCL925L45	MCL930L45	MCL935L45	MCL940L45
L 550mm	MCL920L55	MCL925L55	MCL930L55	MCL935L55	MCL940L55

MCL940L45

**Pinces**

L 400mm

Pinces	Mors crocodile	Mors curette Ø 4mm	Mors curette s'ouvrant en haut 3,5x10mm	Mors curette coudée dessus Ø 4mm
L 400mm	7844T3L40	7844T5L40	7844T6L40	7844T7L40
L 450mm	7844T3L45	7844T5L45	7844T6L45	7844T7L45
L 500mm	7844T3L50	7844T5L50	7844T6L50	7844T7L50
L 550mm	7844T3L55	7844T5L55	7844T6L55	7844T7L55
L 600mm	7844T3L60	7844T5L60	7844T6L60	7844T7L60

7844T5L40

**Oesophagoscope**

**MCL320** Oesophagoscope seul sans poignée ni fibre  
12x16mm

**MCL330** Oesophagoscope seul sans poignée ni fibre  
12x16mm

L 300mm

Poignée MCL112H

Fibre MCL320F

L 500mm

Poignée MCL112H

Fibre MCL330F

Container  
**7874MF-61**  
640x189x95mm - L 610x180x80mm

Echelle 1/3

Echelle 1/4

Longueur utile - «L»



	2mm	2,5mm	3mm	3,5mm	4mm
L 250mm	MCL920L25	MCL925L25	MCL930L25	MCL935L25	MCL940L25
L 350mm	MCL920L35	MCL925L35	MCL930L35	MCL935L35	MCL940L35

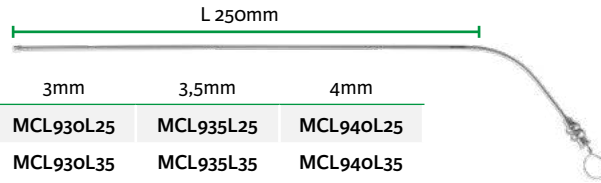

**Aspirateur boutoné**

MCL930L25

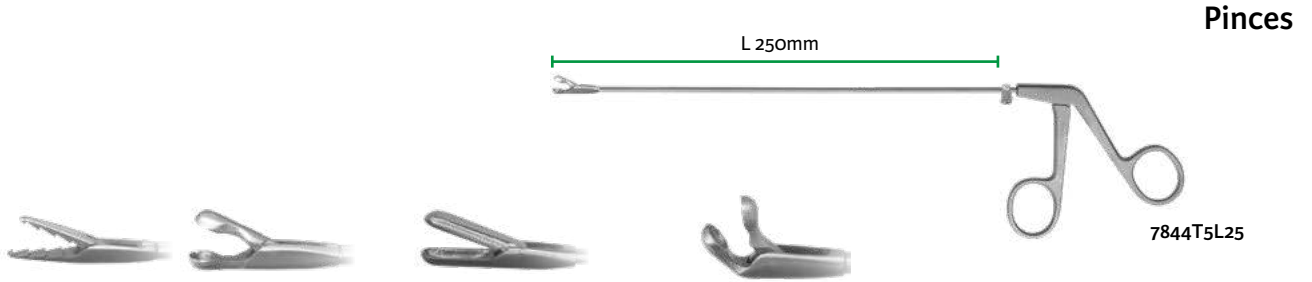

**Pinces**

7844T5L25

Pinces	Mors crocodile	Mors curette Ø 4mm	Mors curette s'ouvrant en haut 3,5x10mm	Mors curette coudée dessus Ø 4mm
L 200mm	7844T3L20	7844T5L20	7844T6L20	7844T74L20
L 250mm	7844T3L25	7844T5L25	7844T6L25	7844T74L25
L 300mm	7844T3L30	7844T5L30	7844T6L30	7844T74L30
L 350mm	7844T3L35	7844T5L35	7844T6L35	7844T74L35

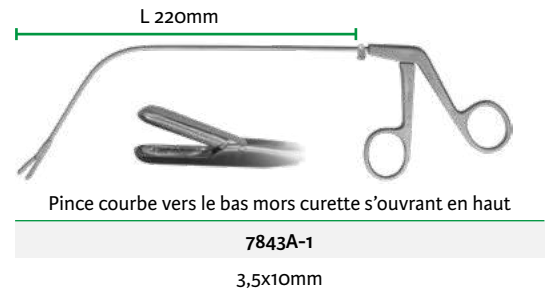
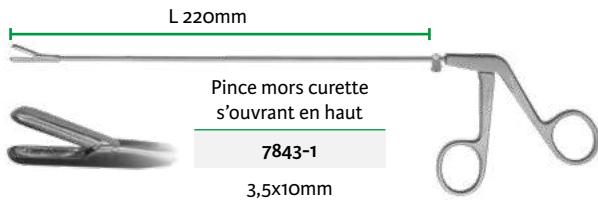

**Hypopharyngoscope**

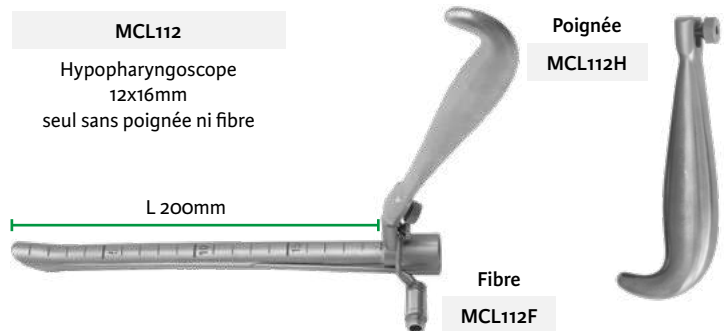
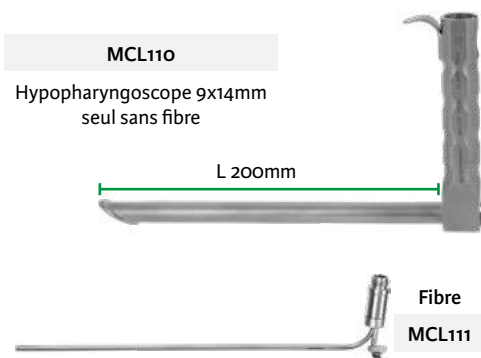

Echelle 1/3

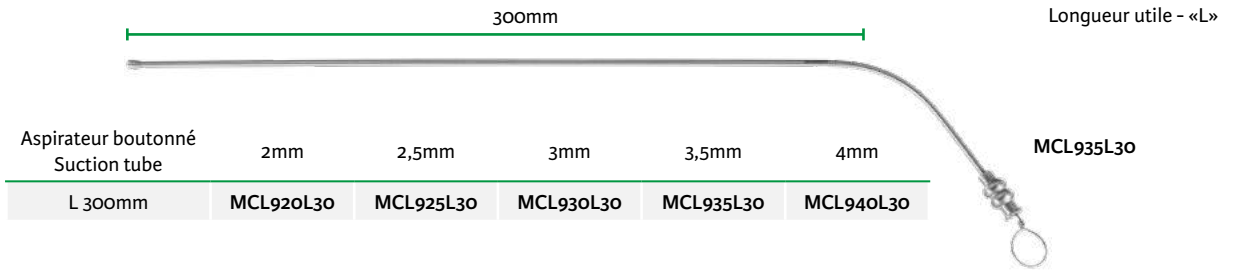

**Diverticuloscope de Lacau**

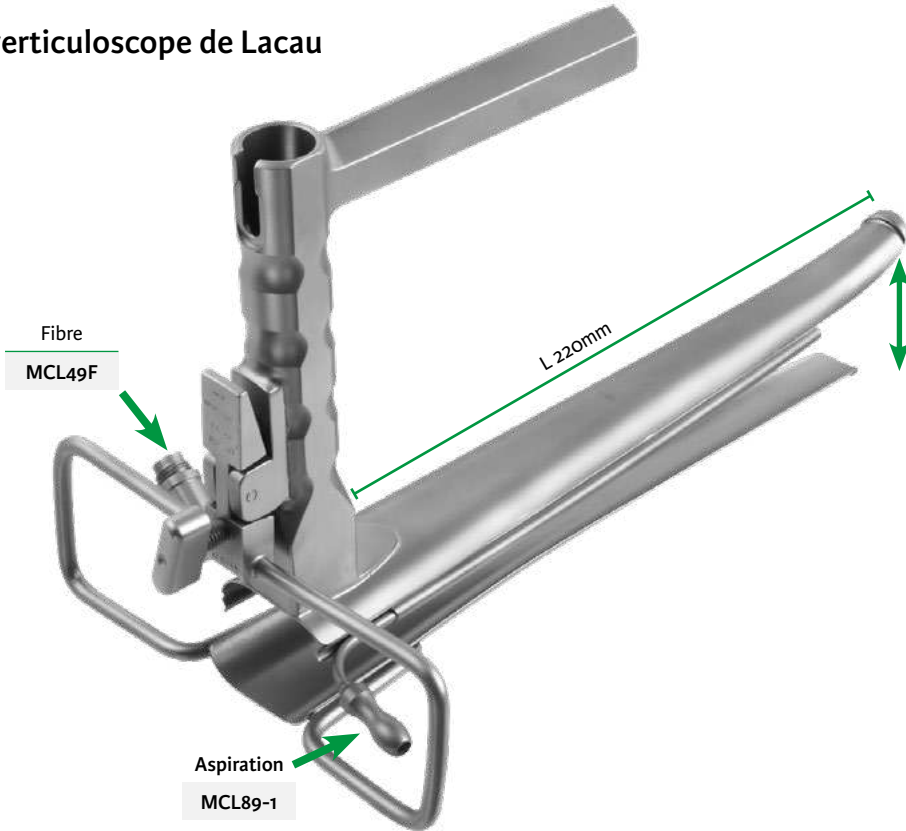

Diverticuloscope seul  
sans aspirateur ni fibre

**MCL49**  
Articulé

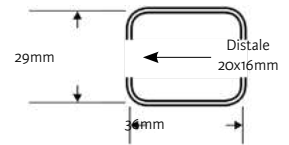

**Diverticuloscope de Reyt**

Diverticuloscope seul  
sans aspirateur ni fibre

**MCL88**  
250mm

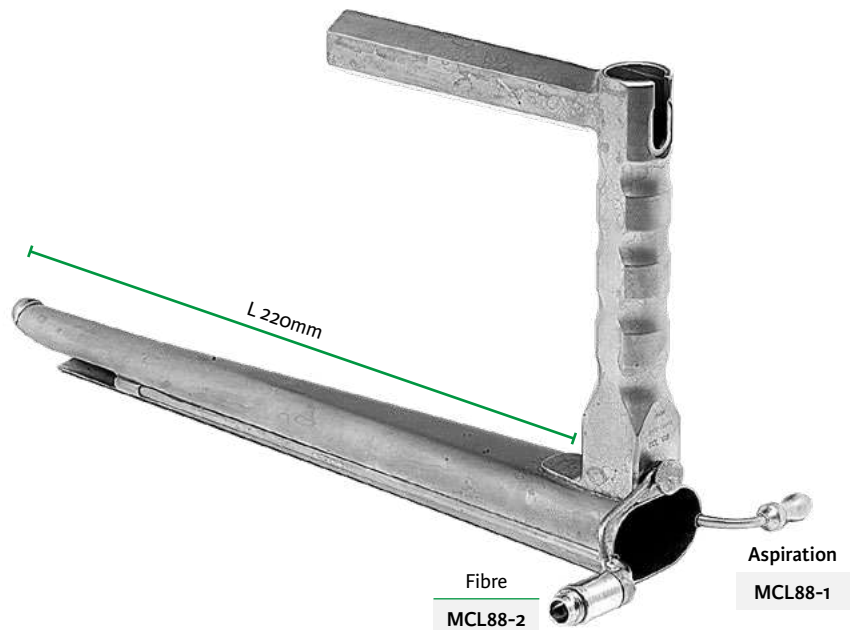
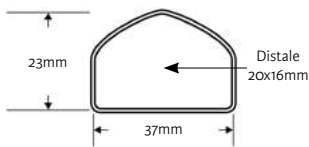

Photos à titre indicatif, sans échelle

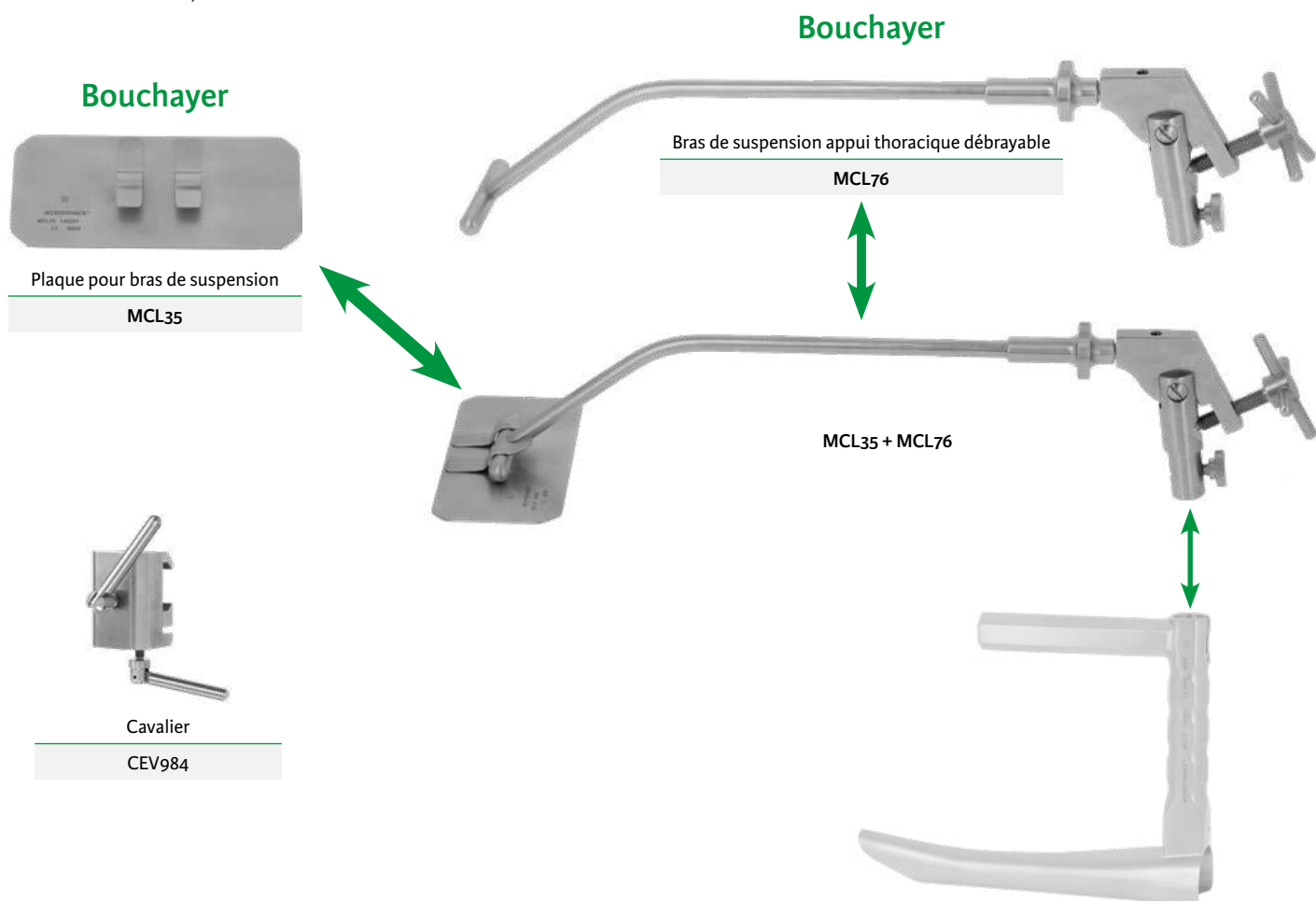

**Lumière froide**



Raccords	côté générateur	côté instrument
<b>Wolf</b>	MCL170 <sup>(D)(1)*</sup>	MCL171 <sup>(D)(1)*</sup>
<b>Storz</b>	MCL173 <sup>(D)(1)*</sup>	MCL174 <sup>(D)(1)*</sup>
<b>Olympus</b>	MCL197 <sup>(D)(1)*</sup>	

<sup>(D)</sup> Distribué par Integra MicroFrance SAS (France) - Voir tableau d'équivalence annexe pour la référence du fabricant correspondante.  
\* Veuillez vérifier auprès de votre représentant commercial la disponibilité de ce produit dans votre pays.

<sup>(1)</sup> Produit non dispositif médical

Echelle 1/3

Longueur utile - «L»

**Lescanne**

**MCL37D**

livré sans fibre

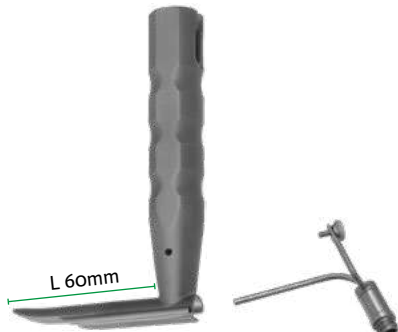
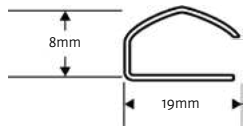

Fibre

**MCL37DF**

**Lescanne**

**MCL37C**

livré sans fibre

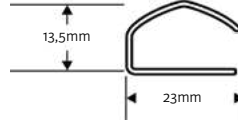

Fibre

**MCL37CF**

**Garabédian**

**MCL37G**

livré sans fibre

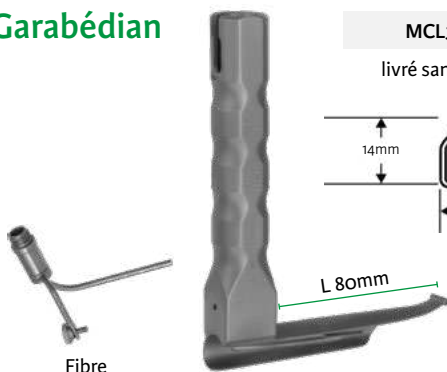
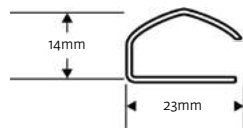

Fibre

**MCL42**

**Garcin**

**MCL37**

livré sans fibre

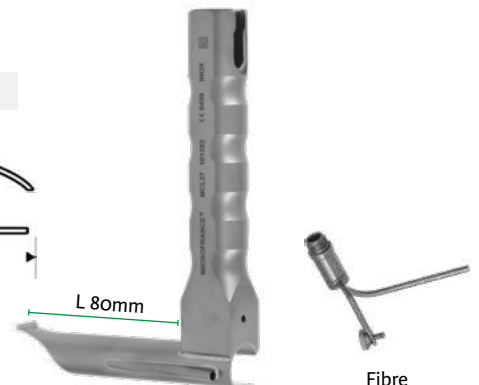
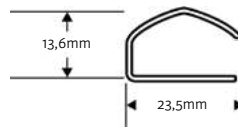

Fibre

**MCL42**

**Legent**

**MCL52**

livré sans fibre

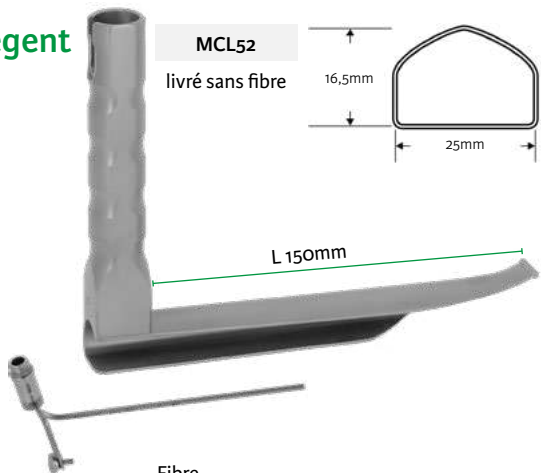
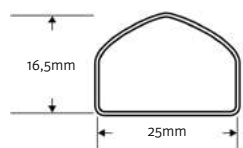

Fibre

**MCL54**

**Legent**

**MCL51**

livré sans fibre

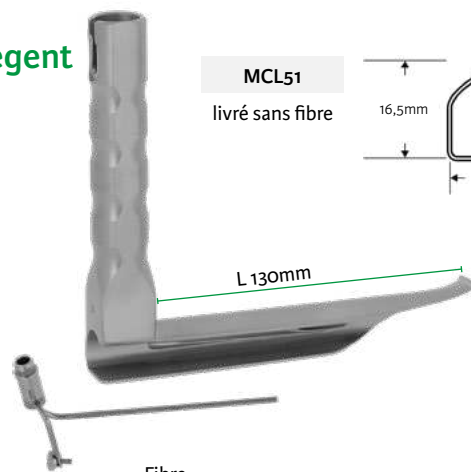
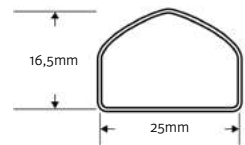

Fibre

**MCL53**



Echelle 1/3

Longueur utile - «L»

**Bouchayer**

**MCL79**  
livré sans fibre

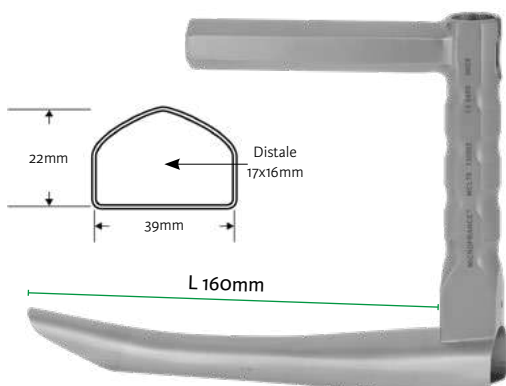

Fibre  
**MCL78**

**Bouchayer**

**MCL77**  
livré sans fibre

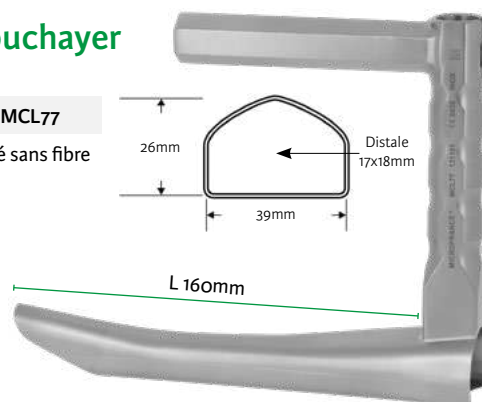

**Pignat**

**MCL64**  
livré sans fibre  
Petite taille

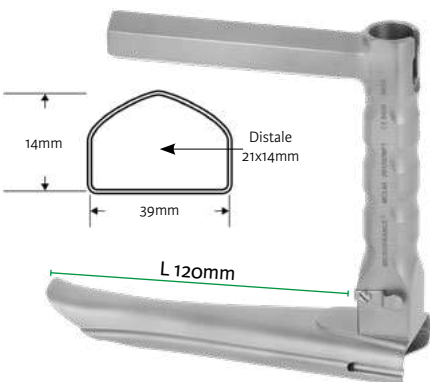

Fibre  
**MCL64F**

**Pignat**

**MCL63**  
livré sans fibre  
Grande taille



Fibre  
**MCL63F**

Echelle 1/3

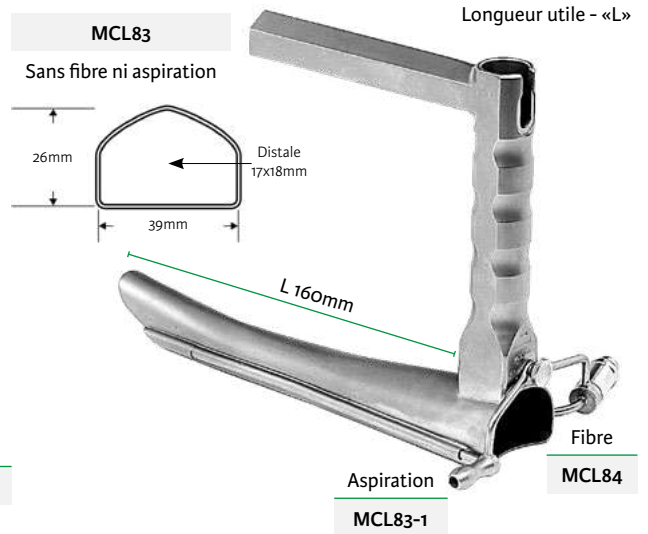
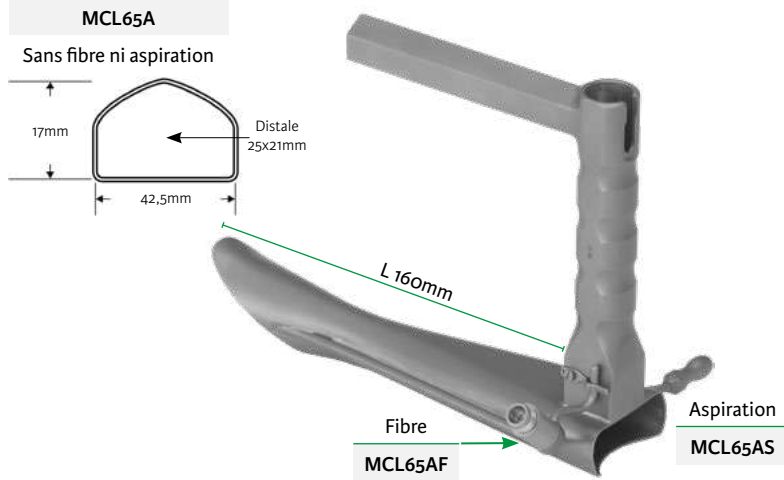

**Abitbol**

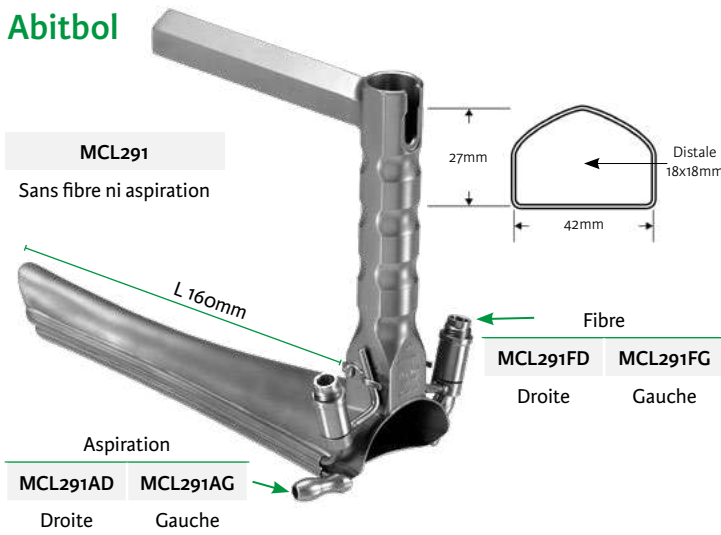

**Brasnu**

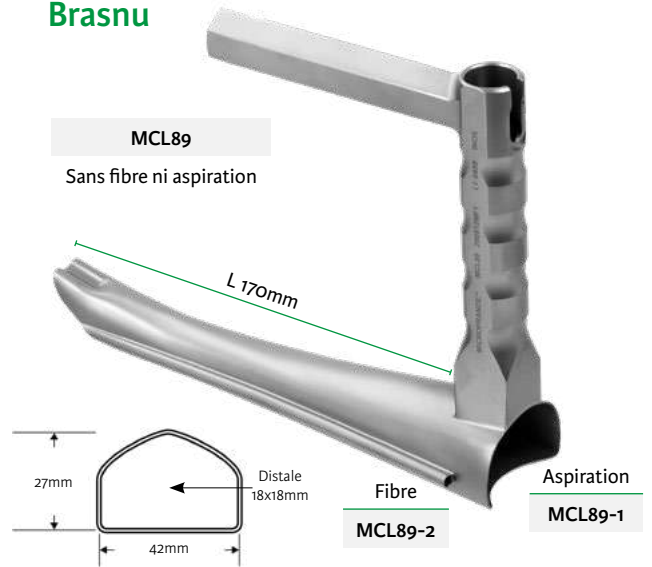

**Abitbol**

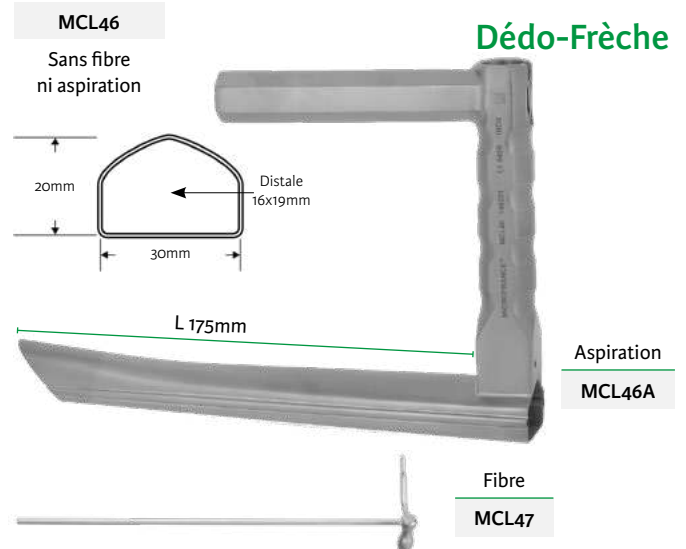
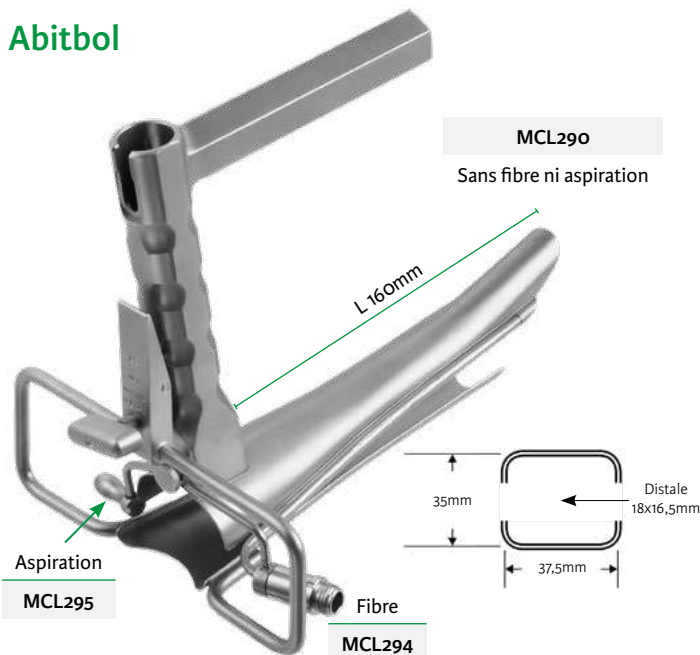

Echelle 1/3

**Sataloff**

Longueur utile - «L»

**MCL120**

taille pédiatrique  
Avec fibre et aspiration

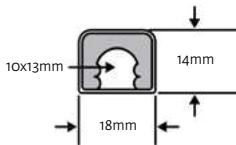

**MCL121**

taille médium homme  
Avec fibre et aspiration

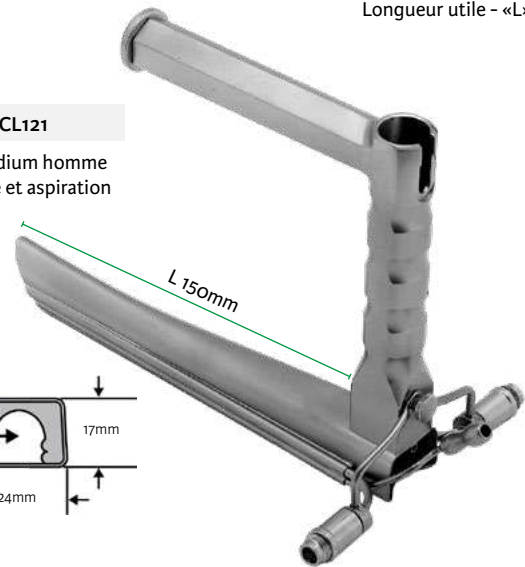
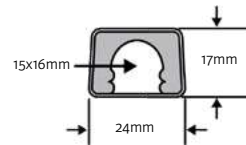

**MCL122**

taille adulte  
Avec fibre et aspiration

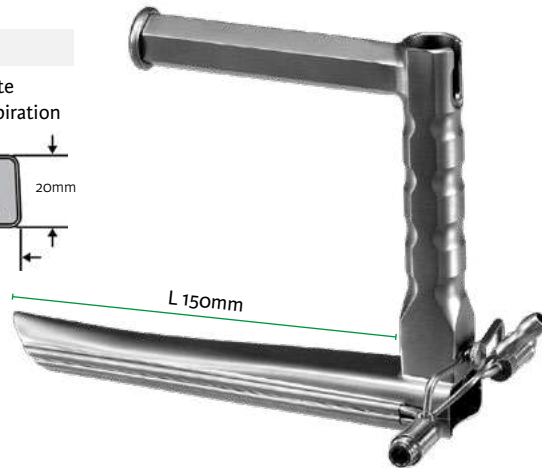
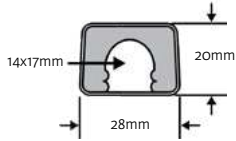

**MCL123**

taille médium femme  
Avec fibre et aspiration

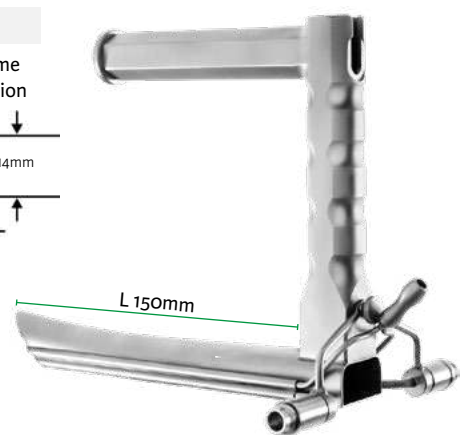
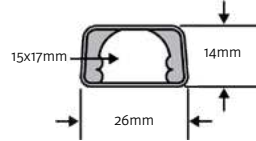

**MCL124**

«sillon épiglottique»  
Avec fibre et aspiration

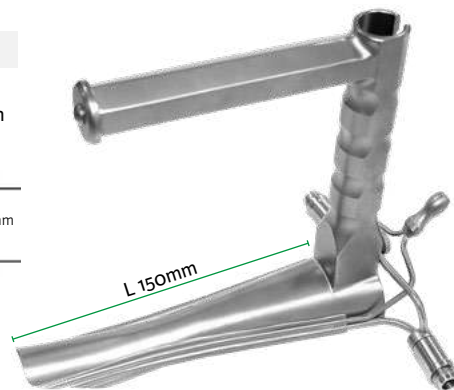
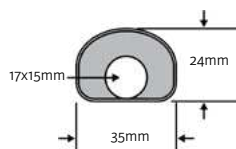

**MCL125**

Avec fibre et aspiration

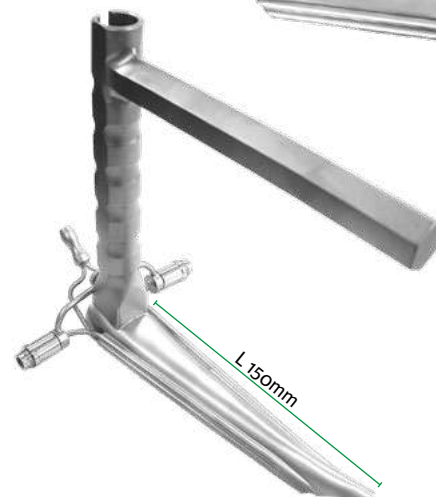
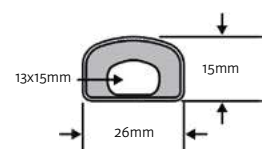

Laryngoscope complet	Fibre à lumière froide droite	Fibre à lumière froide gauche	Aspirateur double
MCL120	MCLS120-2	MCLS120-1	MCLS120-3
MCL121	MCLS121-2	MCLS121-1	MCLS121-3
MCL122	MCLS122-2	MCLS122-1	MCLS122-3
MCL123	MCLS123-2	MCLS123-1	MCLS1233
MCL124	MCL124FR	MCL124FL	MCL124ST
MCL125	MCL125FR	MCL125FL	MCL125ST

**Aspirateur raccord olivaire**

**Bouchayer**

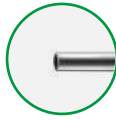

MCL10  
Ø 2,5mm



**Aspirateur boutonné à crépine**

**Brasnu**



MCL100  
Ø 2,5mm

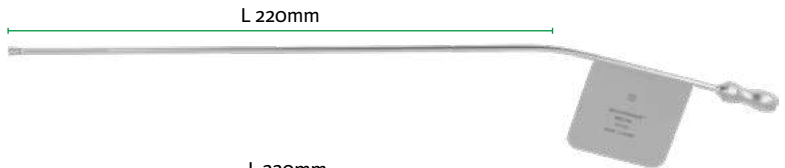

**Garabédian**



MCL100T20 MCL100T15  
Ø 2,0mm Ø 1,5mm

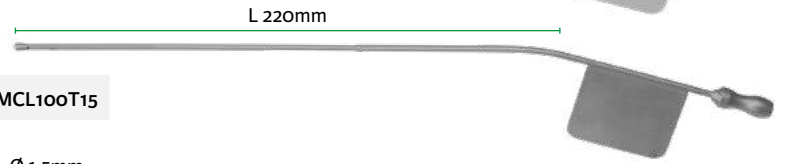

**Aspirateur gainé à soupape**

**Abitbol**

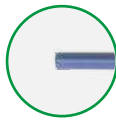

MCL210  
Ø 2,5mm



**Aspirateur double**

**Huttenbrink**

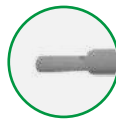

MCL103  
Ø 2,5mm



**Aspirateur de Sataloff**

**Sataloff**

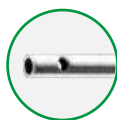

Micro aspirateur à crépine  
MCL-S16



Micro aspirateur rétracteur dessous  
MCL-S17



Micro aspirateur rétracteur dessus  
MCL-S17-1



MCL-S17

Longueur utile - «L»

Echelle 1/3

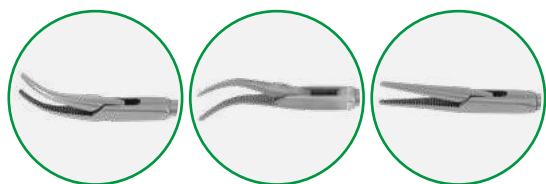

<b>MCL18</b> A droite	<b>MCL15</b> A gauche	<b>MCL25</b> Droite
--------------------------	--------------------------	------------------------

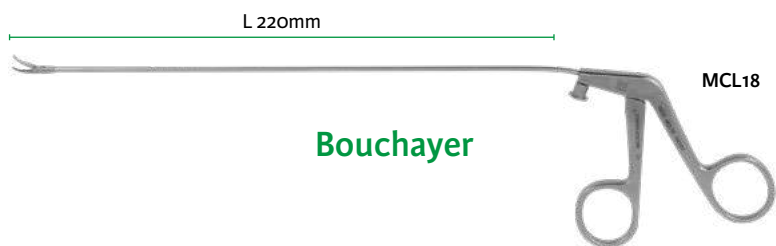

<b>MCL19</b> A gauche	<b>MCL19BIS</b> A droite
--------------------------	-----------------------------

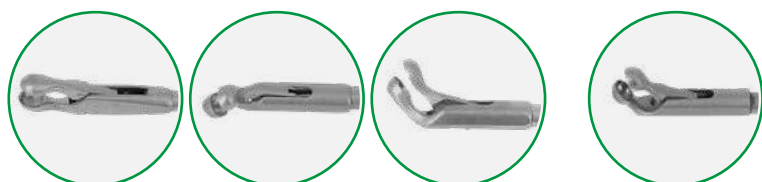
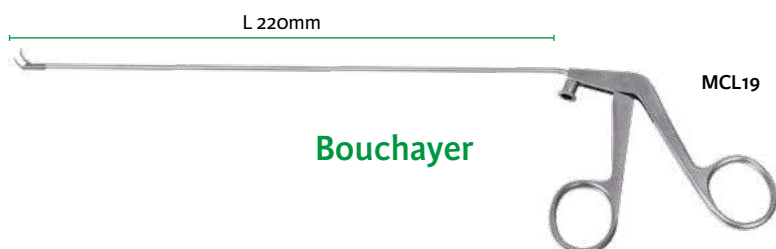

<b>MCL12</b>	<b>MCL29</b> A gauche 45°	<b>MCL30</b> A droite 45°	<b>MCL33</b> Coudée dessus
--------------	---------------------------------	---------------------------------	-------------------------------

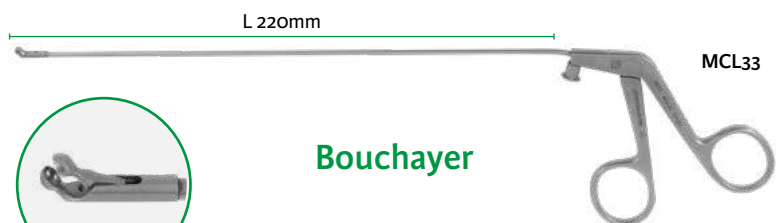

<b>MCL67</b> Coudée dessus	<b>MCL68</b> A gauche	<b>MCL69</b> A droite
-------------------------------	--------------------------	--------------------------

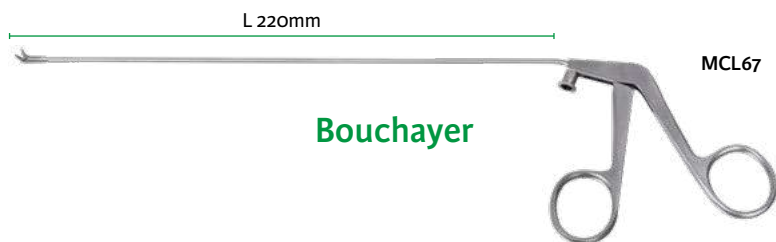

Echelle 1/2

**Ciseaux**

**Bouchayer**

L 220mm



MCL11

Droit



MCL31

Coudés dessus - 45°



MCL16

Courbe à droite

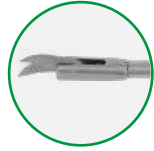

MCL17

Courbe à gauche



MCL11

**Bistouri lancéolé, Décolleurs**

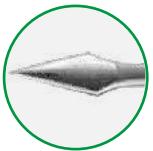

Bistouri lancéolé

MCL57



Décolleur coudé 90°

MCL81BL

à gauche



MCL81BR

à droite



Décolleur courbe

MCL56BL

à gauche



MCL56BR

à droite

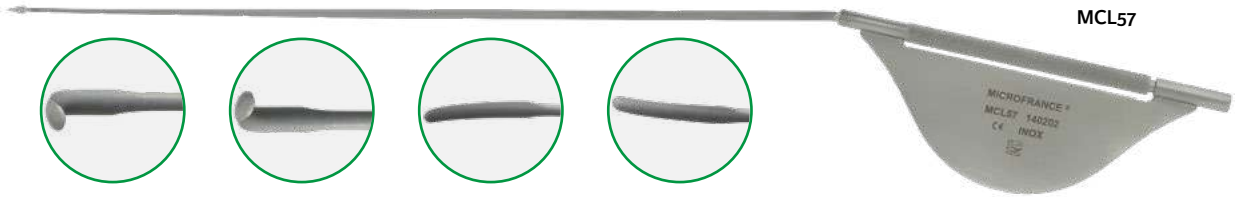

MCL57

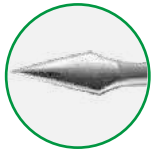

Bistouri lancéolé : poignée et 3 lames

MCL93

Jeu de 3 lames

MCL93-2



MCL93

**Micro porte-aiguille**



MCL94

mors droits  
1,5x5mm

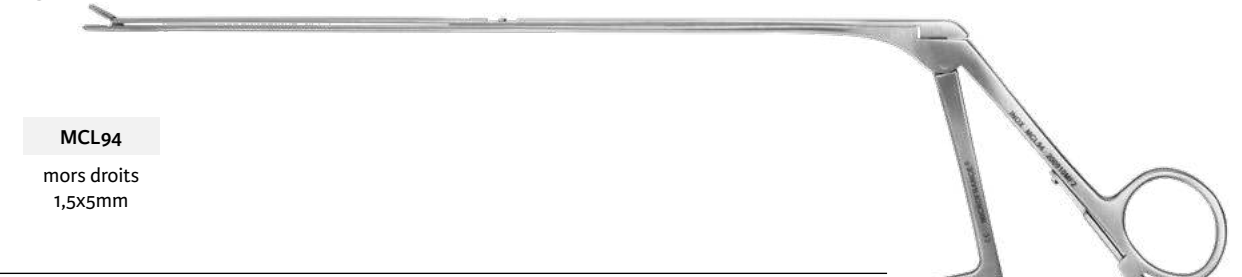

**Micro pince écarteur à crémaillère**

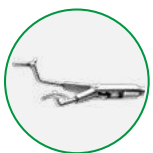

MCL82



Echelle 1/2

L 220mm

**Décolleurs**



Micro décolleur coudé 90°

Micro décolleur courbe

<b>MCL81PL</b> à gauche	<b>MCL81PR</b> à droite	<b>MCL56PL</b> à gauche	<b>MCL56PR</b> à droite
----------------------------	----------------------------	----------------------------	----------------------------



Echelle 1/3

**Poignée stylet et insert porte-aiguille**

Micro porte-aiguille poignée et insert

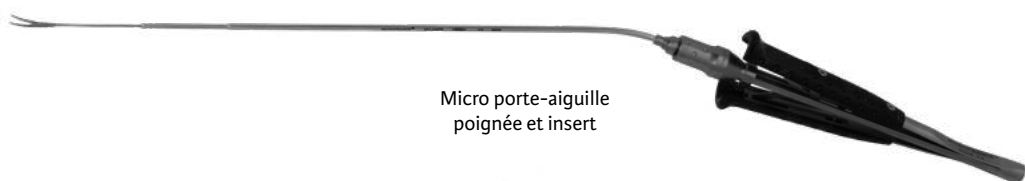

Insert porte-aiguille mors lisses tungstène

**MCL94IPR**

**MCL94IP**

courbe à droite

courbe à gauche

livré avec un raccord MCEN39L pour lavage



**MCL94IPR**

Poignée stylet sans crémaillère

**MCL828**



**MCEN39L**

Raccord luer-lock pour lavage insert  
Boîte 3

**Abitbol**

Echelle 1/3

Longueur utile - «L»

**Micro aspirateur gainé à soupape**

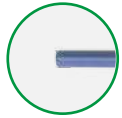

MCL210

Ø 2,5mm

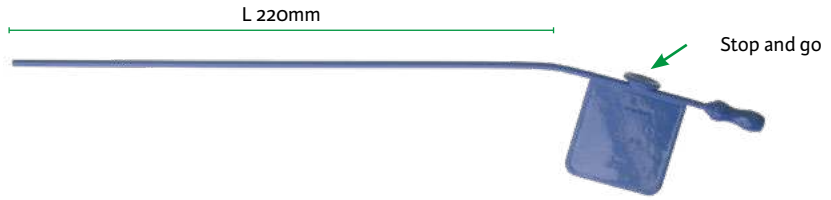

**Pince mors fenêtrés**



MCL205



**Pince mors en coeur**



MCL219

Courbe à droite



MCL219-1

Courbe à gauche

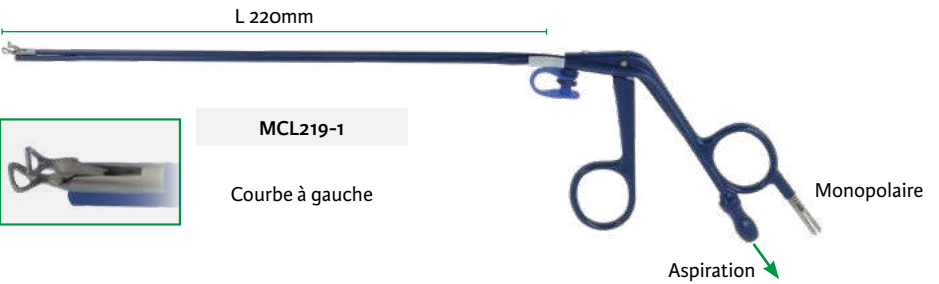

**Pince mors alligator**



MCL241

Courbe à droite



MCL241-1

Courbe à gauche

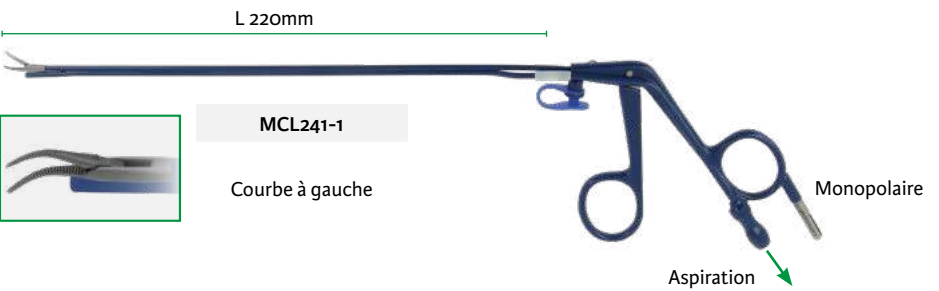

Câbles monopolaires - 3,5 m



CP391E

Erbe ACC ICC/VIO Storz Wolf



CP391M

Aesculap Berchtold Lamidey Martin Erbe T Serie Sutter BM-780 II



CP391V

Bowa Bovie Conmed Valleylab



Echelle 1/2 Longueur utile - «L»

**Manche de bistouri, lames**

Lames de bistouri stériles, usage unique, Boîte 25  
Echelle 2/3

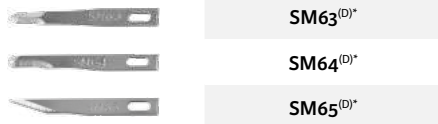

Diastème laryngé - pédiatrie

CP821E

Manche de bistouri 170mm

**Garabédian**

Echelle 1/3

L 180mm

Micro porte-aiguille pédiatrique  
poignée et insert



Insert porte-aiguille mors lisses tungstène



MCL94IG

livré avec un raccord  
MCEN39L pour lavage



MCEN39L

Raccord luer-lock  
pour lavage insert  
Boîte 3

Poignée stylet à crémaillère

MCL828C

**Porte-aiguille**

**Garabédian**

Echelle 1/2

L 230mm

Porte-aiguille mors tungstènes



MCL94G

Nettoyage  
instrument

**Garabédian**

**Bistouri, crochet, écarteur**

Echelle 1/2

L 220mm



MCL4

Bistouri 3x4mm



MCL5

Bistouri 45° 2mm



MCL7

Crochet mousse



MCL48

Ecarteur 7mm

**Micro Faux**

Echelle 1/2

Micro faux courbe 10mm

L 220mm



MCL1BIS

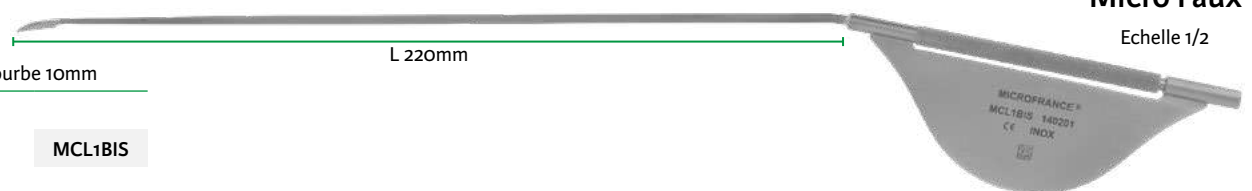

<sup>(D)</sup> Distribué par Integra MicroFrance SAS (France) - Voir tableau d'équivalence annexe pour la référence du fabricant correspondante.  
\* Veuillez vérifier auprès de votre représentant commercial la disponibilité de ce produit dans votre pays.

**Parsons**

Micro canule à irrigation laryngée

L 200mm

Echelle 1/2  
Longueur utile - «L»

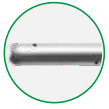

**MCL98**

Ø 1,5mm



**Bouchayer**

Aiguille à injection en baïonnette

L 210mm



**MCL58**

Ø 0,5mm

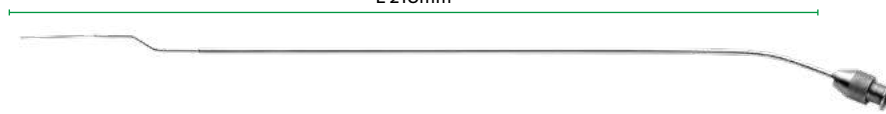

**Woo**

Ciseaux lames 5mm

L 200mm



**MCLW10**

droits

**MCLW11**

coudés dessus 45°

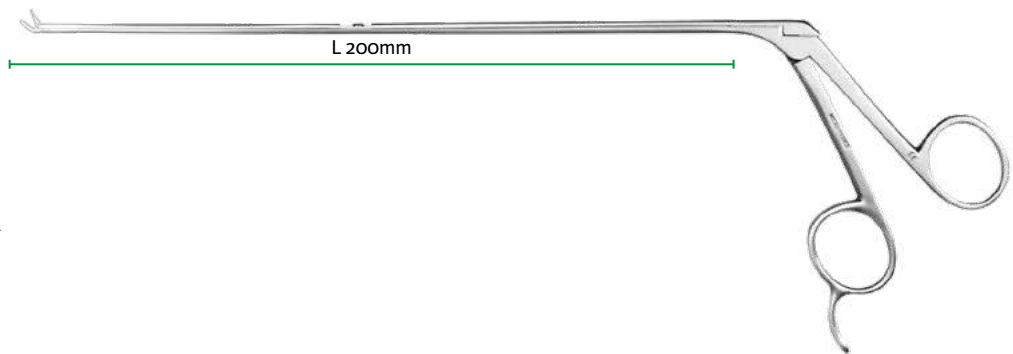

**3734115**

Micro bistouri

L 250mm



**Lowinger**

Sonde double

**MCL101**

Ø 2,5mm / 1mm  
280mm

**MCL102**

Ø 2mm / 1mm  
260mm

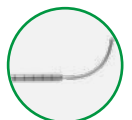

Echelle 1/3

Longueur utile - «L»

## Instruments monopolaires

### Frèche

Micro pointe baïonnette

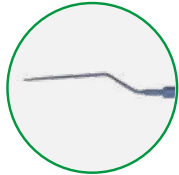

MCL59



Aspirateur à soupape

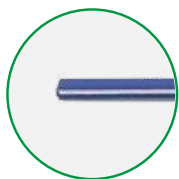

MCL62

Ø 2,5mm

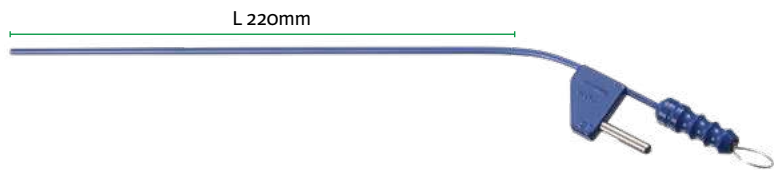

Câbles monopolaires - 3,5 m



CP391E

Erbe ACC ICC/VIO Storz Wolf



CP391M

Aesculap Berchtold Lamidey Martin Erbe T Serie Sutter BM-780 II



CP391V

Bowa Bovie Conmed Valleylab

## Pinces bipolaires

Micro pince mors droits



MCL34



Livré avec container

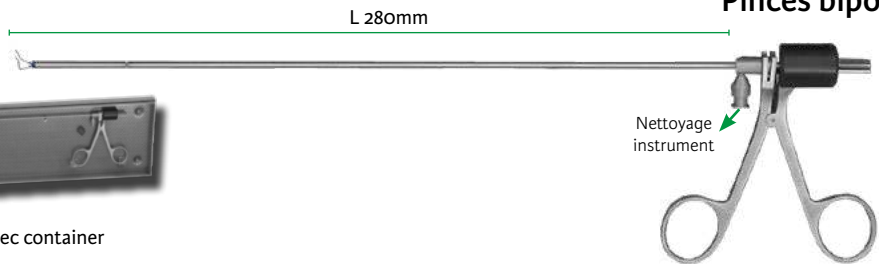

### Peretti

Micro pince mors coudés



MCL340

Mors 45° - 2mm

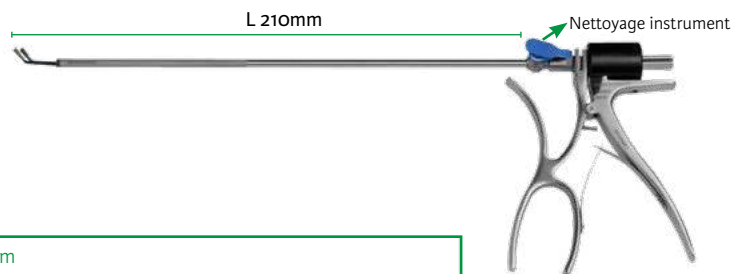

Câbles bipolaires - 4,5 m



CP393-2

Bowa Emc Lamidey Valleylab



CP393-3

Storz Wolf Erbe VIO ICC ACC (sauf international)



CP393-4

Aesculap Berchtold Martin Sutter BM-780 II

**Pistolet pour injection, aiguille à injection**

Echelle 1/3  
Longueur utile - «L»

**Bouchayer**

Aiguille à injection en baïonnette Ø 1mm



MCL55-1



MCL55-2  
à droite



MCL55-3  
à gauche

Aiguilles à injection droites malléables Ø 0,5mm



MCL55U

Bte 6 - Usage unique  
livré non stérile



L 220mm



MCL55-1

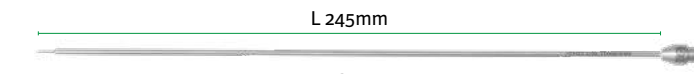

L 245mm

MCL55U

Pistolet pour injection

MCL55

livré avec aiguille MCL55-1

MCL55B

livré avec raccord MCL55R

Raccord luer-lock



MCL55R

Echelle 1/1

**Injection laryngée transcervicale**

**Casiano**

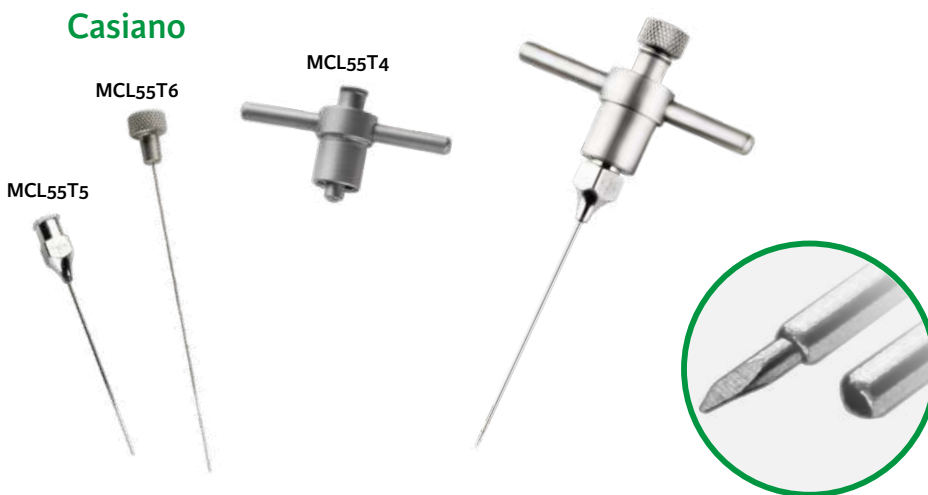

MCL55T6

MCL55T4

MCL55T5

Poignée pour aiguille

MCL55T4

Mandrin

MCL55T6

Aiguille à injection  
Ø 0,8mm L 40mm - Boîte 6

MCL55T5

Livré non stérile

Aiguille à injection droite - 80 mm Ø 0.4 mm

MCL-S4

Boîte 6

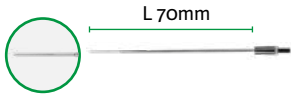

Aiguille à injection coudée - 80 mm Ø 0.4 mm

MCL-S5

Boîte 6

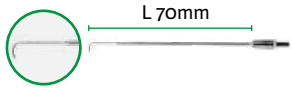

Raccord luer-lock droit  
165mm

L 145mm

MCL-S0

Raccord luer-lock  
angulé  
50 mm

MCL-S27

Echelle 1/3

Longueur utile - «L»

Aiguille à injection droite  
90mm Ø 1,3mm

L 50mm



MCL-S35

### Instruments démontables pour poignée MCL-S19

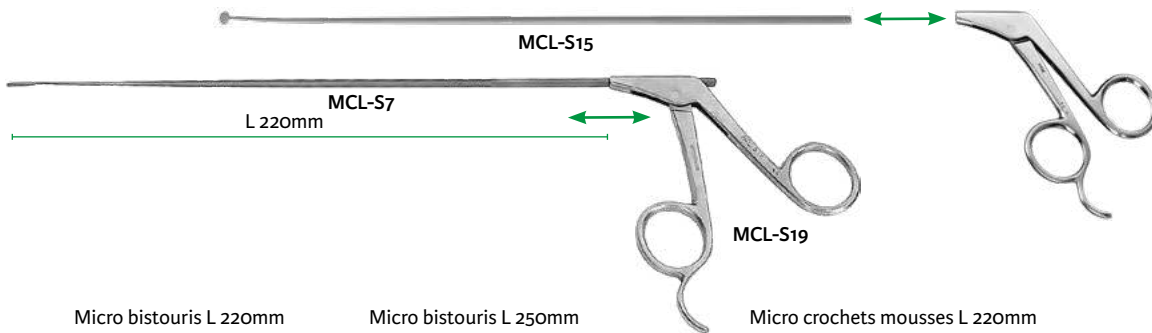

Poignée  
porte-micro instruments  
MCL-S19

Micro bistouris L 220mm

Micro bistouris L 250mm

Micro crochets mousses L 220mm

Micro décolleurs L 220mm



MCL-S6 MCL-S20 MCL-S25 MCL-S9 MCL-S26

MCL-S11 MCL-S12 MCL-S13

MCL-S8 MCL-S1 MCL-S7

falciforme droit 7mm boîte 6  
vasculaire 2mm  
falciforme courbe 6mm boîte 6  
tranchant 90° 2mm  
90° 3mm

45° Ø 3mm  
90° Ø 2,5mm  
90° Ø 3mm

coudé 8mm 20°  
courbe 1x9mm  
droit 1x10mm

Instruments L 220mm

L 250mm

Ecarteur Miroir Palpeur Porte-coton

Curette courbe à kyste

Miroir



MCL-S2 MCL-S14 MCL-S10 MCL-S3

MCL-S38

MCL-S15

Pointu, 2 griffes 70° - Ø 3mm

19mm

Ø 1mm

70° - Ø 4mm

Echelle 2/3  
Longueur utile - «L»

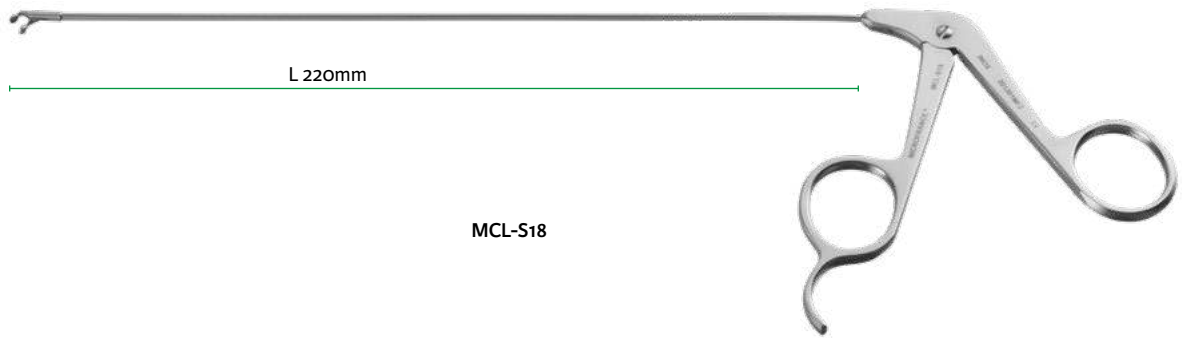

MCL-S18

Pince mors curettes



MCL-S18

Coudées dessous

Pince mors en cœur



MCL-S21

A droite



MCL-S22

A gauche

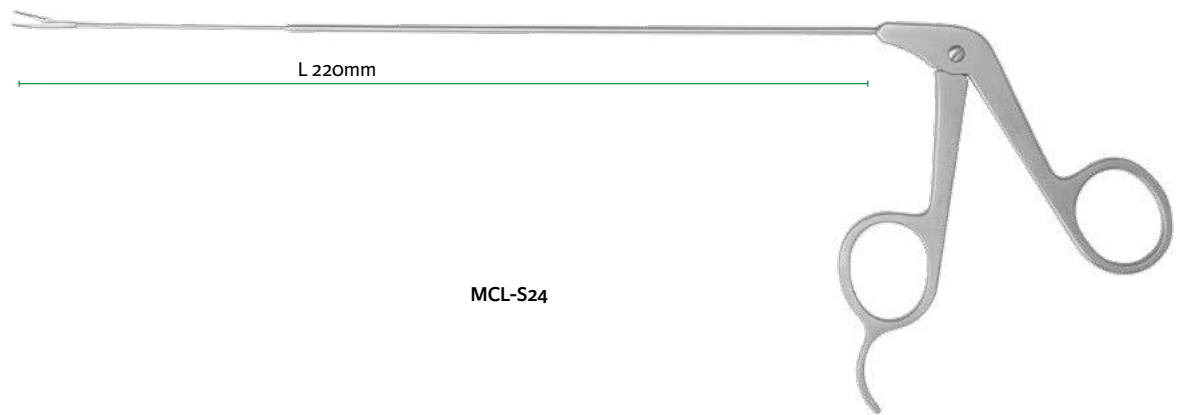

MCL-S24

Pince mors striés



MCL-S23

A droite



MCL-S24

A gauche



MCL-S39

A droite  
Mors larges



MCL-S41

A gauche  
Mors larges

Echelle 1/3

Longueur utile - «L»

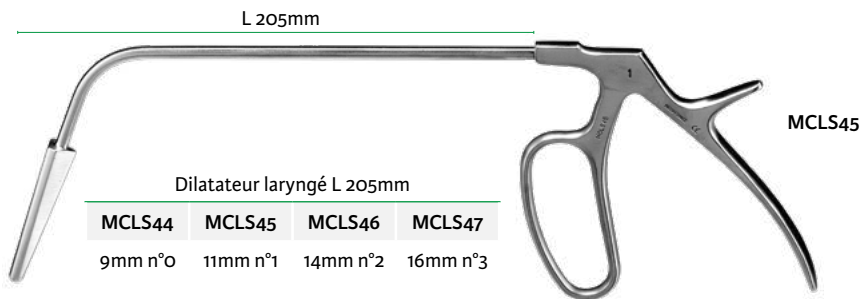

Micro pince mors curettes Ø 2,4mm - L 180mm



MCL49	MCL50	MCL51
mors droits	mors à gauche	mors à droite

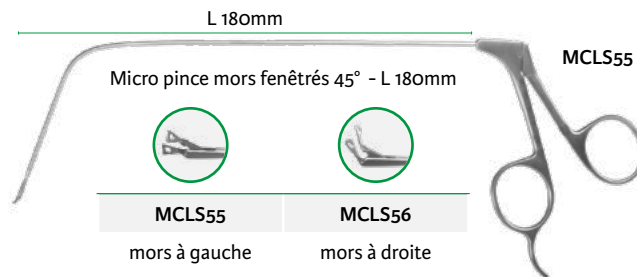

Micro ciseaux lames 3mm - L 180mm



MCL52	MCL53	MCL54
droits	courbe à droite	courbe à gauche

Micro pince mors striés Ø 5mm - L 180mm



MCL57	MCL58	MCL59
mors droits	mors à droite	mors à gauche

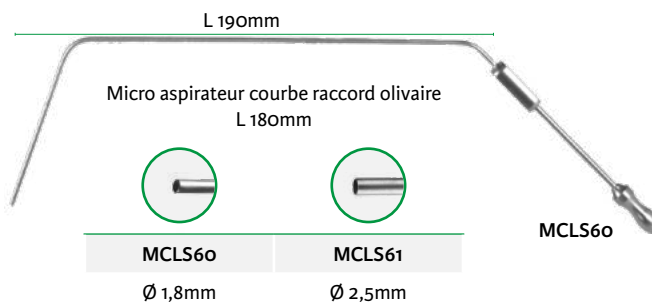
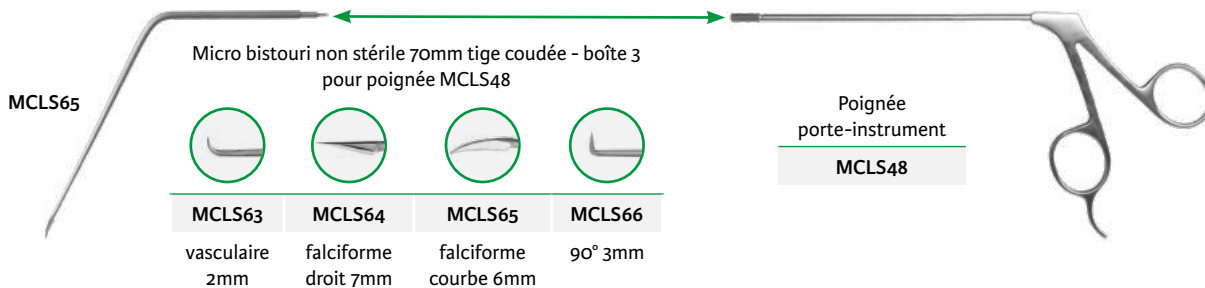

Aiguille à injection Ø 0,7mm - Boîte 6



Echelle 1/3

Longueur utile 220mm



Ciseaux



**MCLB16**

Courbe à droite

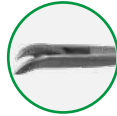

**MCLB17**

Courbe à gauche



**MCLB31**

Coudés dessus

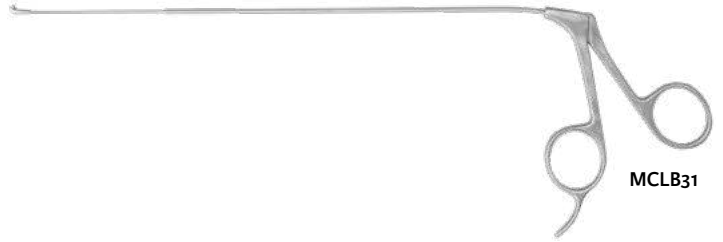

**MCLB31**

Pince mors curettes



**MCLS18R**

280mm

Coudées dessus

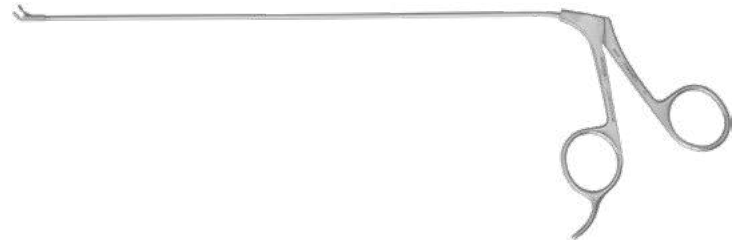

Pince mors en cœur



**MCL-S21R**

A droite



**MCL-S22R**

A gauche

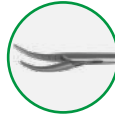

**MCL-S23R**

A droite



**MCL-S24R**

A gauche

Pince mors striés



**MCL-S22R**

Porte-aiguille



**MCLB94**

280mm

Mors coudés - 45°



Pousse-noeud



**MCLB30**

250mm





Echelle 1/2  
Longueur utile «L»



Bague de fixation  
pour trocart Ø 10mm

**MCLP70**

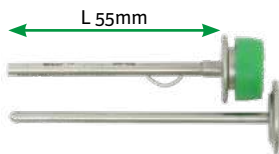

Trocart complet sans valve  
avec mandrin mousse

**MCLP10**

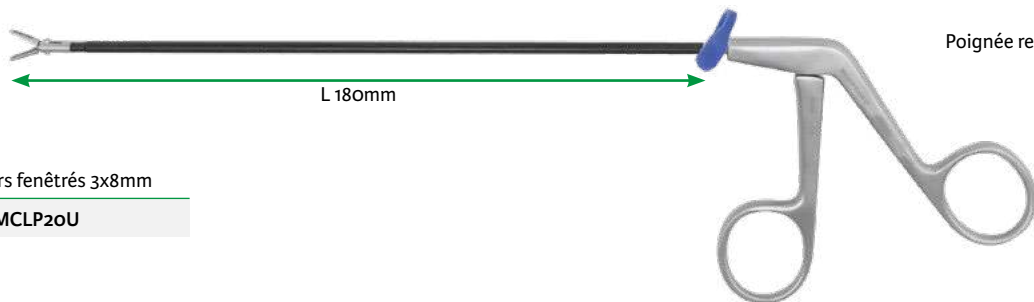

Pince mors fenêtrés 3x8mm

**MCLP20U**

Poignée revolver



Pince mors fenêtrés 3x8mm

**MCLP25U**

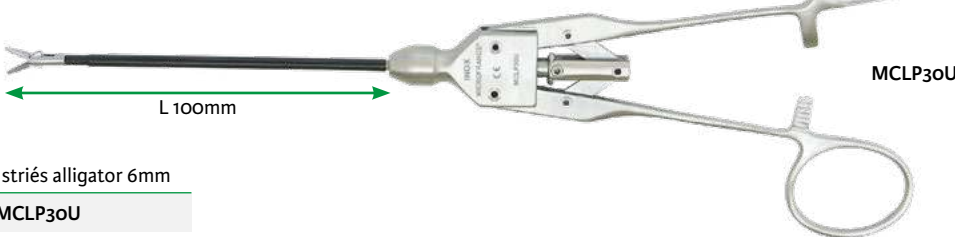

**MCLP30U**

Poignée axiale



Pince mors striés alligator 6mm

**MCLP30U**



Ciseaux courbes à droite lames 4mm

**MCLP40U**

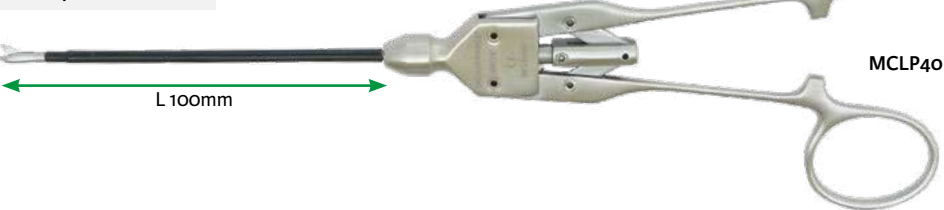

**MCLP40U**

Poignée axiale



Crochet monopolaire

**MCLP50**



**MCLP50**









Palpateur boutoné

**MCLP60**

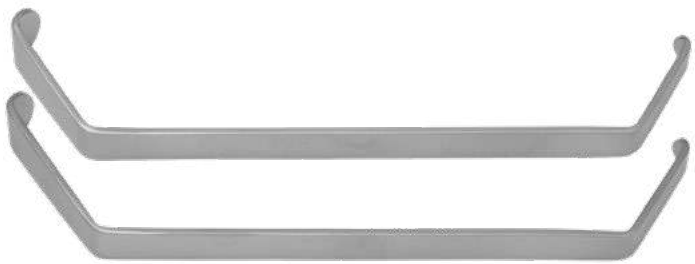

**MCLP60**

L 180mm









		Ecarteur double 2 valves mousses 180mm	
<b>MCLT10</b>	petite taille 8x35 / 15x40mm		
<b>MCLT11</b>	grande taille 8x35 / 15x50mm		
		Décolleur courbe 190mm	
<b>MCLT20</b>	2mm		
<b>MCLT21</b>	4mm		
		Décolleur Aspirateur 200mm Ø 3mm	
<b>MCLT40</b>	malléable, à soupape		
		Aspirateur à soupape et crépine 200mm Ø 3mm	
<b>MCLT50</b>	malléable		
		Porte-boule de coton 200mm Ø 3mm poignée axiale	
<b>MCLT30</b>			

## Chirurgie robotique de la thyroïde

<b>MCLT12R</b>	Ecarteur	
<b>MCLT13R</b>	Ecarteur aspirateur	non représenté
<b>MCLT21R</b>	Décolleur courbe Ø 4mm 440mm	
<b>MCLT40R</b>	Décolleur aspirateur malléable Ø 3mm 270mm	
<b>MCLT50R</b>	Micro aspirateur malléable à soupape et crépine 330mm	

**Trocart métal**

Longueur utile	
50 mm	80 mm



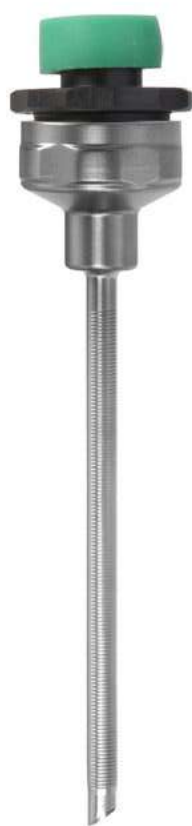



Mandrin	mousse		<b>CEV8143A4</b>	<b>CEV143A4</b>
	pointu		<b>CEV8143A3</b>	<b>CEV143A3</b>
Joint capuchon	Vert		<b>CEV103P6</b> Boîte 6	
Tête de trocart	à valve aimantée		<b>CEV177A3</b> livré complet avec une valve aimantée et un joint capuchon vert	
	à valve silicone		<b>CEV127T3</b> livré complet avec une valve silicone et un joint capuchon vert	
Valve pour tête de trocart	Aimantée		<b>CEV179A5</b> Boîte 6	
	Silicone		<b>CEV125P6</b> Boîte 6	
Chemise métal crénelée	Avec robinet		<b>CEV8143A7</b>	<b>CEV143A7</b>
	Sans robinet		<b>CEV8143B7</b>	<b>CEV143B7</b>



Echelle 1/1

**Trocart composite à valve silicone**



			Longueur utile	
			45 mm	70 mm
Mandrin 	mousse 	<b>CEV8826M (1)</b>	<b>CEV326M (1)</b>	
	pointu 	<b>CEV8826P (1)</b>	<b>CEV326P (1)</b>	
Joint capuchon	Vert 	<b>CEV103P6</b> Boîte 6		
Valve pour tête de trocart	Silicone 	<b>CEV125P6</b> Boîte 6		
Corps de trocart composé d'une tête de trocart avec chemise composite à valve silicone	avec chemise lisse sans robinet 	<b>CEV8826L (1)</b>	<b>CEV326L (1)</b>	
		<b>CEV8826V (1)</b>	<b>CEV326V (1)</b>	
	avec chemise à pas de vis sans robinet 	<b>CEV8826L (1)</b>	<b>CEV326L (1)</b>	
		<b>CEV8826V (1)</b>	<b>CEV326V (1)</b>	

(1) Nouvelle référence

### Crochet monopolaire



**CEV890**  
225mm Ø 3,5mm

**Montupet**



**CEV890C**  
90° 225mm Ø 3,5mm



Page 69

### Bistouri à lame rétractable



**CEV898**  
90mm Ø 3,5mm  
Livré avec une lame CEV898L



**CEV898L**  
Lame de bistouri pour pylorotomie  
Boîte 3

### Aspirateurs irrigateurs

Aspirateur irrigateur gradué 50/100/150mm bout rétreint et crépine



**CEV8103G3** Canule graduée pour poignée CEV103GH  
ou CEV103BG  
Ø 3,5mm 195mm



**CEV103GH** Poignée de commande















(1) Nouvelle référence **CEV103BG (1)** Poignée de commande















**CEV896**  
Ø 3,5mm 220mm

Aspirateur irrigateur à robinet bout rétreint et crépine



<b>NON démontable</b>			
<b>Instruments complets : pinces bipolaires</b>			
Mors Echelle 1/1		Poignée	Longueur utile
 Pince mors striés bipolaires 1,5mm		 Revolver, bipolaire	<b>CEV897</b> 250 mm
		 1/3	
 Pince mors fenêtrés bipolaires 10x3mm		 Ergonomique, bipolaire	<b>CEV897BG</b> 250 mm
		 1/3	
 Pince mors spatulés bipolaires 2,0mm		 Ergonomique, bipolaire	<b>CEV897C</b> 250 mm
		 1/3	

Câbles bipolaires - 4,5 m		
 <b>CP393-2</b> Bowa Emc Lamidey Valleylab	 <b>CP393-3</b> Storz Wolf Erbe VIO ICC ACC (sauf international)	 <b>CP393-4</b> Aesculap Berchtold Martin Sutter BM-780 II

Semi-démontable		
Inserts - Tubes		Poignée
Mors avec tube gainé Echelle 1/1	Longueur utile	N° Pages
 Insert Babcock	CEV891IU 235 mm	      <b>Rotatif</b> page 82 - 83
 Insert ciseaux courbes lames crantées 8 mm	CEV893IU 230 mm	
 Insert ciseaux droits lames crantées 8mm	CEV894IU 230 mm	
 Insert mors fenêtrés 3x12mm	CEV895IU 235 mm	
 Insert mors à griffes grip-pince	CEV899IU 220 mm	
 Insert mors striés alligator 6 mm	CEV896IU 235 mm	
 Insert dissector passe-fil courbure moyenne à gauche 10 mm	CEV898IU 230 mm	
	CEV39L Raccord luer lock pour lavage insert et tube	 

## Démontable

### Instruments rotatifs

Poignées revolver  
bague noire de rotation  
Echelle 1/3



Crémaillère externe  
Poignée deux branches mobiles

CEV1019T5BU  
Modèle large



Crémaillère interne  
Poignée une branche mobile

CEV10195CU



Crémaillère externe  
Poignée une branche mobile

CEV10195DU



Crémaillère externe  
Poignée une branche mobile

CEV10195RU



sans crémaillère  
Poignée deux branches mobiles

CEV1039T5TBU  
Modèle large



sans crémaillère  
Poignée une branche mobile

CEV10395DU



sans crémaillère  
Poignée une branche mobile

CEV10395RU



sans crémaillère  
Poignée gainée une branche mobile

CEV1039G5U



## Démontable

### Instruments rotatifs

Poignées axiales  
 Bague noire de rotation  
 Echelle 1/3

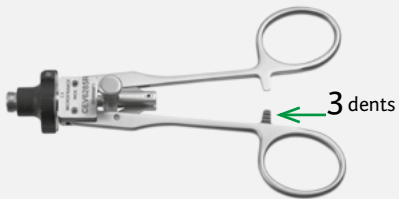

Crémaillère interne 3 dents

CEV6285R



Sans crémaillère

CEV6385RU



Crémaillère interne longue 5 dents

CEV628P5



Crémaillère externe longue

CEV728T5

## Démontable

### Instruments rotatifs

Poignées ergonomiques  
bague noire de rotation  
Echelle 1/3

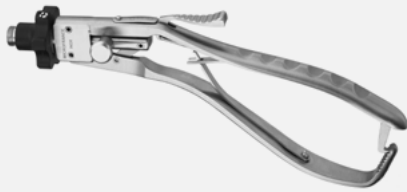

Grip large  
A crémaillère débrayable

CEV720BRUC



Poignée fine  
A crémaillère débrayable

CEV720RU











**Elhadad**  
Poignée fine  
A crémaillère

CEV7285RU











Grip large  
A crémaillère débrayable

CEV728BR5U





<b>NON démontable</b>		
<b>Instruments complets</b>		
Mors Echelle 1/1	Poignée	Longueur utile
 <b>Montupet</b> Pince mors Babcock	 Revolver avec crémaillère longue	<b>CEV891MU</b> 200 mm
 <b>Montupet</b> Ciseaux droits lames crantées 8mm	 Revolver	<b>CEV894MU</b> 220 mm
 <b>Montupet</b> Pince mors fenêtrés 3x12mm	 Revolver avec crémaillère longue	<b>CEV895MU</b> 195 mm
 Pince mors à griffes grip-pince	 Revolver avec crémaillère longue	<b>CEV899U</b> 220 mm

**NON démontable**

Instruments complets : Instruments de **De Lagausie**

Mors Echelle 1/1	Poignée	Longueur utile
 Pince mors fenêtrés 3x12mm	 Axiale	CEV995MU 220 mm
 Ciseaux droits lames crantées 8mm	 Axiale	CEV996MU 220 mm
 Pince mors striés alligator 6mm	 Axiale	CEV997MU 210 mm
 Dissecteur courbure moyenne à gauche 10mm	 Axiale	CEV998MU 220 mm

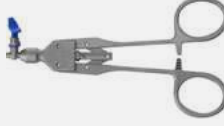
**Porte-aiguille**

 <b>Montupet</b> Porte-aiguille mors droits tungstène	 Revolver avec crémaillère longue	CEV892 220 mm
 <b>Reinberg</b> Porte-aiguille mors droits	 Axiale	CEV992 220 mm
 Porte-aiguille mors courbes tungstène	 Axiale	CEV992D 220 mm

## Cupule

7876-60<sup>(D)\*</sup>

## Cupule

7876-60 <sup>(D)*</sup>	60mm
7876-80 <sup>(D)*</sup>	80mm
7876-100 <sup>(D)*</sup>	100mm
7876-120 <sup>(D)*</sup>	120mm
7876-160 <sup>(D)*</sup>	160mm

## Plateau inox

7872-24<sup>(D)\*</sup>  
Echelle 1/2

## Plateau inox

7872-24 <sup>(D)*</sup>	240x180mm
-------------------------	-----------

<sup>(D)</sup> Distribué par Integra MicroFrance SAS (France) - Voir tableau d'équivalence annexe pour la référence du fabricant correspondante.  
 \* Veuillez vérifier auprès de votre représentant commercial la disponibilité de ce produit dans votre pays.

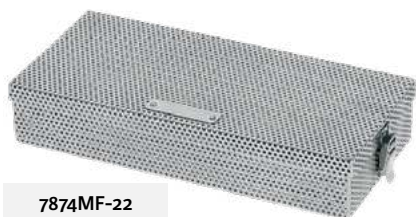

**7874MF-22**

220x100x40mm

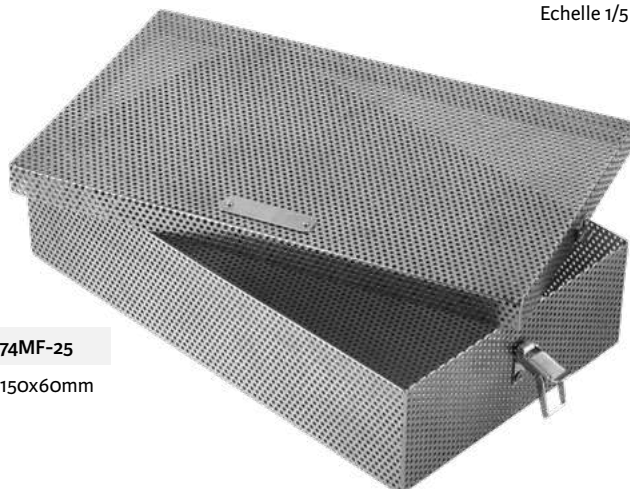

**7874MF-25**

250x150x60mm

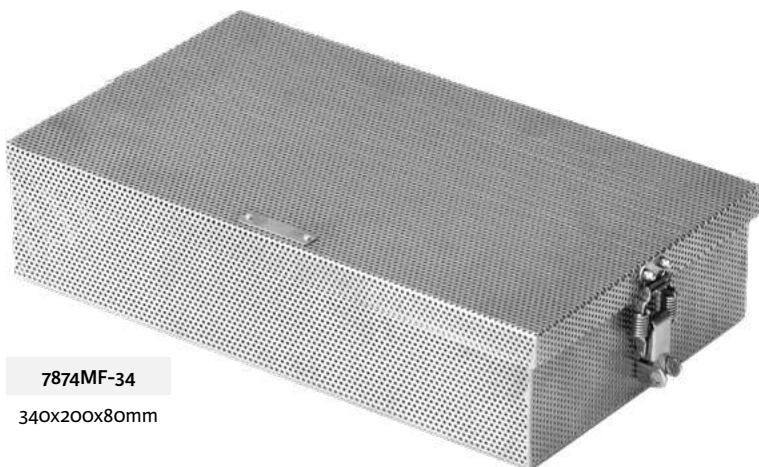

**7874MF-34**

340x200x80mm

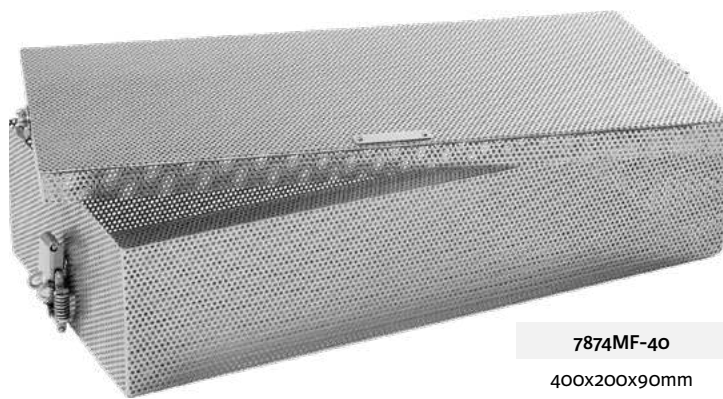

**7874MF-40**

400x200x90mm

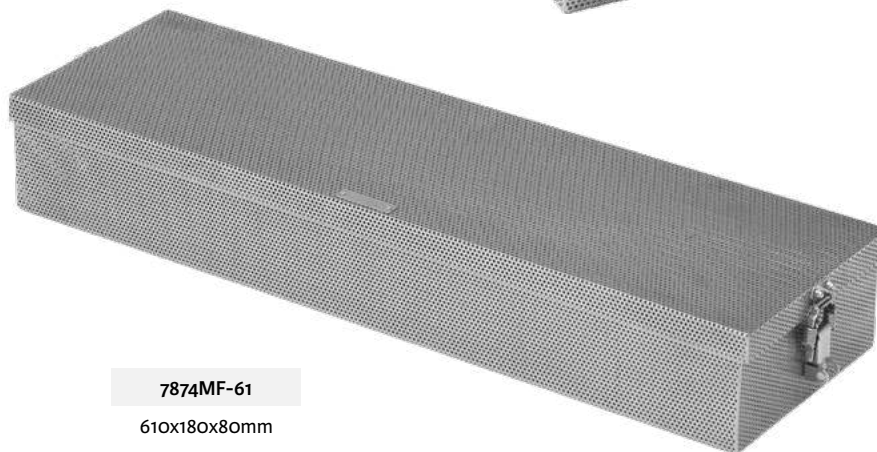

**7874MF-61**

610x180x80mm

Photos à titre indicatif, sans échelle

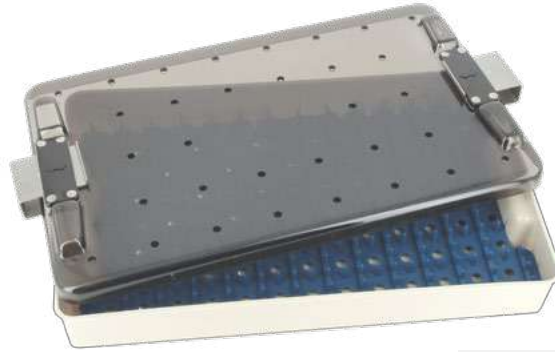

MCEN136SC

270x160x35mm



3717011

528x250x123mm

Photos à titre indicatif, sans échelle



3717001

530x250x140mm

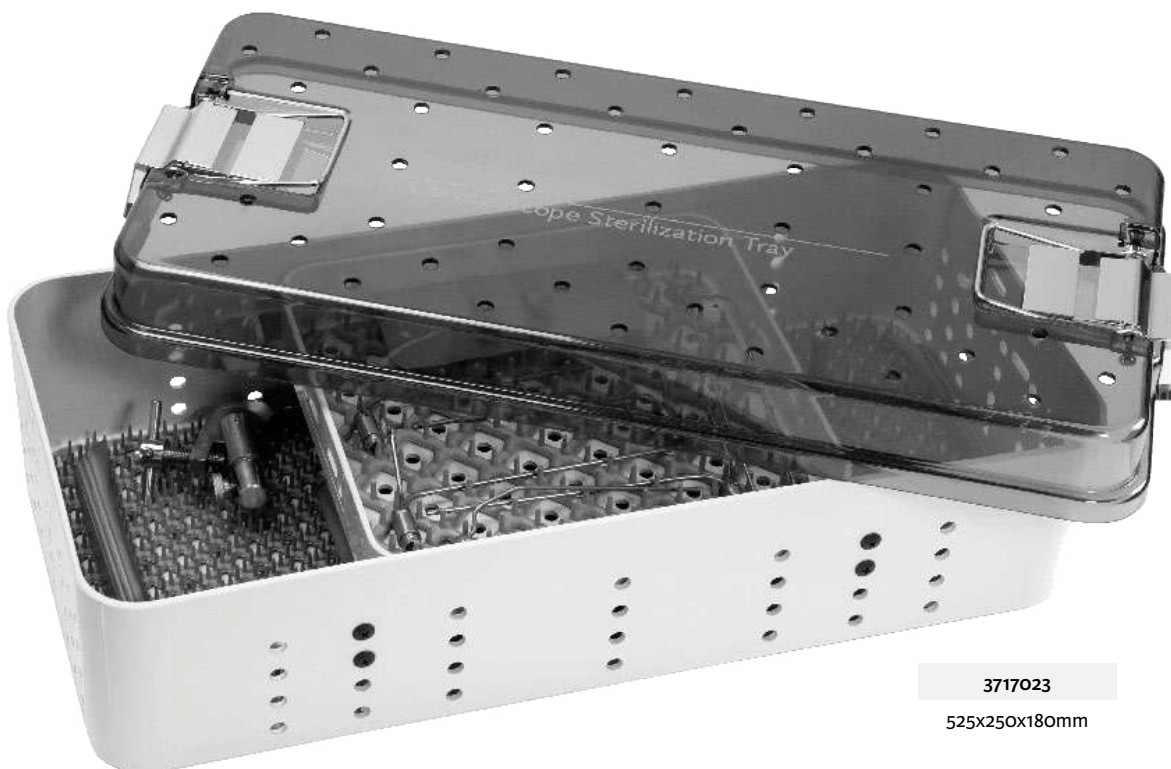

3717023

525x250x180mm



## **Index numérique**

**0**

0-28-7 ..... 26

**1**

1003IG(D) ..... 21  
1003LI(D) ..... 12, 21  
1004IG(D) ..... 21  
1005I(D) ..... 21

**3**

3714O27 ..... 25  
3714O28 ..... 25  
3717001 ..... 89  
3717011 ..... 13  
3717023 ..... 90  
3724O59 ..... 22  
3734O42 ..... 13  
3734115 ..... 68

**7**

701T ..... 49  
702T ..... 48  
703T ..... 48  
704T ..... 48  
714T ..... 48  
720T ..... 49  
7755-1-0-4 ..... 15  
7755-1-0-5 ..... 15  
7755-1-0-6 ..... 15  
7768 ..... 24  
7768-1 ..... 24  
7773 ..... 28  
7781 ..... 27  
7782-1-2 ..... 25  
7787-10 ..... 22  
7796 ..... 2  
7797-1 ..... 10  
7797-2 ..... 10  
7798T1(D) ..... 2  
7798T(D) ..... 2  
7800MF ..... 10  
7802C ..... 4  
7802P ..... 3, 4, 9  
7802S-1 ..... 4  
7802S-2 ..... 4  
7802S-3 ..... 4  
7802S-4 ..... 4  
7802S-5 ..... 4  
7803B ..... 4

7803C ..... 3  
7803S-1 ..... 3  
7803S-2 ..... 3  
7803S-3 ..... 3  
7804-9 ..... 6  
7804-11 ..... 6  
7804-13 ..... 6  
7805-11 ..... 6  
7805-13 ..... 6  
7808L-1 ..... 15  
7808L-2 ..... 15  
7808L-3 ..... 15  
7808M ..... 15  
7809MF ..... 5  
7810 ..... 15  
7811 ..... 12  
7812 ..... 12  
7813 ..... 15  
7813-1 ..... 15  
7814 ..... 12  
7814M ..... 12  
7815 ..... 12  
7819 ..... 11  
7820 ..... 11  
7821A ..... 5  
7821B ..... 5  
7822 ..... 11  
7823 ..... 11  
7825 ..... 11  
7826-1-7 ..... 11  
7828-1-10 ..... 14  
7828-1-13 ..... 14  
7828-1-16 ..... 14  
7828-1-19 ..... 14  
7828-10 ..... 14  
7828-13 ..... 14  
7828-16 ..... 14  
7828-19 ..... 14  
7829-10 ..... 14  
7829-13 ..... 14  
7829-16 ..... 14  
7829-19 ..... 14  
7830M ..... 16  
7831A-12 ..... 37  
7831A-15 ..... 39  
7831A-18 ..... 41  
7831A-20 ..... 42  
7832 ..... 42  
7833A-12 ..... 37  
7833A-15 ..... 39  
7833A-18 ..... 41  
7833A-20 ..... 42  
7834 ..... 42

7835 ..... 16  
7837-18 ..... 16  
7838 ..... 16  
7839 ..... 16  
7840 ..... 16  
7843-1 ..... 55  
7843A-1 ..... 55  
7844T3L20 ..... 55  
7844T3L25 ..... 55  
7844T3L30 ..... 55  
7844T3L35 ..... 55  
7844T3L40 ..... 54  
7844T3L45 ..... 54  
7844T3L50 ..... 54  
7844T3L55 ..... 54  
7844T3L60 ..... 54  
7844T5L20 ..... 55  
7844T5L25 ..... 55  
7844T5L30 ..... 55  
7844T5L35 ..... 55  
7844T5L40 ..... 54  
7844T5L45 ..... 54  
7844T5L50 ..... 54  
7844T5L55 ..... 54  
7844T6L20 ..... 55  
7844T6L25 ..... 55  
7844T6L30 ..... 55  
7844T6L35 ..... 55  
7844T6L40 ..... 54  
7844T6L45 ..... 54  
7844T6L50 ..... 54  
7844T6L55 ..... 54  
7844T6L60 ..... 54  
7844T74L20 ..... 55  
7844T74L25 ..... 55  
7844T74L30 ..... 55  
7844T74L35 ..... 55  
7844T74L40 ..... 54  
7844T74L45 ..... 54  
7844T74L50 ..... 54  
7844T74L55 ..... 54  
7844T74L60 ..... 54  
7857 ..... 10  
7866-13 ..... 53  
7867-1 ..... 50  
7867-2 ..... 50  
7867-3 ..... 50  
7867-4 ..... 50  
7872-24(D) ..... 87  
7874MF-22 ..... 88  
7874MF-25 ..... 88  
7874MF-34 ..... 9, 88

<sup>(D)</sup> Distribué par Integra MicroFrance SAS (France) - Voir tableau d'équivalence annexe pour la référence du fabricant correspondante

7874MF-40.....	88	CEV894MU.....	85	CP332.....	37
7874MF-61.....	54, 88	CEV895MU.....	85	CP335.....	25
7876-60(D).....	87	CEV896.....	79	CP335P.....	29
7876-80(D).....	87	CEV897.....	80	CP344A.....	23
7876-100(D).....	87	CEV897BG.....	80	CP344AT.....	23
7876-120(D).....	87	CEV897C.....	80	CP344B.....	23
7876-160(D).....	87	CEV898.....	79	CP344BT.....	23
7878.....	12	CEV898L.....	79	CP344C.....	23
7879.....	12	CEV899U.....	85	CP344CT.....	23
7884.....	12	CEV984.....	57	CP344D.....	23
7895.....	12	CEV992.....	86	CP344DT.....	23
7920.....	16	CEV992D.....	86	CP344E.....	23
7921.....	16	CEV995MU.....	86	CP344ET.....	23
7923.....	29	CEV996MU.....	86	CP345.....	40
7945T.....	49	CEV997MU.....	86	CP351-1.....	35
7960T40(D).....	3, 5, 9	CEV998MU.....	86	CP351-2.....	34
		CEV1019T5BU.....	82	CP351-3.....	34
		CEV1039G5U.....	82	CP351-5.....	35
		CEV1039T5TBU.....	82	CP351-6.....	34
		CEV6285R.....	83	CP351-7.....	34
		CEV6385RU.....	83	CP352.....	36
		CEV7285RU.....	84	CP352-1.....	36
		CEV8103G3.....	79	CP352-2.....	36
		CEV8143A3.....	77	CP352-3.....	36
		CEV8143A4.....	77	CP353.....	30
		CEV8143A7.....	77	CP354.....	30
		CEV8143B7.....	77	CP354A.....	30
		CEV8826L.....	78	CP355.....	31
		CEV8826M.....	78	CP355A.....	31
		CEV8826P.....	78	CP355C.....	33
		CEV8826V.....	78	CP356.....	30
		CEV10195CU.....	82	CP358.....	30
		CEV10195DU.....	82	CP358A.....	30
		CEV10195RU.....	82	CP362.....	31
		CEV10395DU.....	82	CP363.....	32
		CEV10395RU.....	82	CP365.....	33
				CP367.....	31
				CP367-1.....	31
				CP390-1.....	47
				CP390-2.....	47
				CP390-3.....	46
				CP390-5.....	46
				CP390-7.....	46
				CP390-8.....	47
				CP390L26.....	46
				CP391E.....	12, 46, 47, 66, 69
				CP391M.....	12, 46, 47, 66, 69
				CP391V.....	12, 46, 47, 66, 69
				CP392-1R.....	43
				CP392-2R.....	43
				CP392-3R.....	44
				CP392-5R.....	44
				CP392-8R.....	43

## CEV

## CP

CP392-9R.....44  
 CP392-10R .....44  
 CP392Bl .....43  
 CP392BS .....43  
 CP393-2 ..... 43, 44, 45, 69, 80  
 CP393-3 ..... 43, 44, 45, 69, 80  
 CP393-4 ..... 43, 44, 45, 69, 80  
 CP400.....39  
 CP400-1 ..... 37  
 CP400-2 ..... 41  
 CP401 .....40  
 CP406 ..... 37  
 CP407 .....39  
 CP409 ..... 41  
 CP414 ..... 37  
 CP415 .....39  
 CP604 .....38  
 CP604-15 .....38  
 CP604BR .....43  
 CP604M ..... 47  
 CP605 .....38  
 CP605-15 .....38  
 CP605BR .....43  
 CP605M ..... 47  
 CP606 .....38  
 CP606-15 .....38  
 CP606A .....38  
 CP609 ..... 25  
 CP611 ..... 20  
 CP616-13.....33  
 CP616-15.....33  
 CP625 ..... 20  
 CP626 ..... 20  
 CP627 ..... 20  
 CP628 ..... 24  
 CP637.....32  
 CP818-8 ..... 28  
 CP818-10 ..... 28  
 CP818-12.....28  
 CP818-15.....28  
 CP818-20.....28  
 CP821..... 21  
 CP821E..... 67  
 CP822-10..... 24  
 CP822-12 ..... 24  
 CP822-14 ..... 24  
 CP825.....22  
 CP919 ..... 30  
 CP919A ..... 30  
 CP921..... 33  
 CP922 ..... 32  
 CP922A..... 32  
 CP922B..... 32  
 CP931 ..... 34

CP931-1..... 34  
 CP931-3 ..... 35  
 CP931-5 ..... 35  
 CP933-14 ..... 39  
 CP933-16 ..... 40  
 CP933-18 ..... 41  
 CP934 ..... 39  
 CP934-1 ..... 39  
 CP936 ..... 40  
 CP938-1 ..... 37  
 CP941..... 24  
 CP984 ..... 28  
 CP984-1 ..... 28  
 CP985 ..... 20  
 CP988-15 ..... 39  
 CP988-18 ..... 41  
 CP988-20 ..... 42  
 CP997 ..... 31  
 CP1107 ..... 48

MCL35 ..... 9, 57  
 MCL37 ..... 58  
 MCL37C..... 58  
 MCL37CF..... 58  
 MCL37D ..... 58  
 MCL37DF ..... 58  
 MCL37G ..... 58  
 MCL38N(D)..... 9, 57  
 MCL42 ..... 58  
 MCL46 ..... 60  
 MCL46A ..... 60  
 MCL47 ..... 60  
 MCL48 ..... 67  
 MCL49 ..... 56  
 MCL49F..... 56  
 MCL51 ..... 58  
 MCL52 ..... 58  
 MCL53 ..... 58  
 MCL54 ..... 58  
 MCL55 ..... 70  
 MCL55-1 ..... 70  
 MCL55-2 ..... 70  
 MCL55-3 ..... 70  
 MCL55B..... 70  
 MCL55R..... 70  
 MCL55T4 ..... 70  
 MCL55T5..... 70  
 MCL55T6 ..... 70  
 MCL55U ..... 70  
 MCL56BL ..... 64  
 MCL56BR ..... 64  
 MCL56PL ..... 65  
 MCL56PR ..... 65  
 MCL57 ..... 64  
 MCL58 ..... 68  
 MCL59 ..... 69  
 MCL62 ..... 69  
 MCL63 ..... 59  
 MCL63F ..... 59  
 MCL64 ..... 59  
 MCL64F..... 59  
 MCL65A ..... 60  
 MCL65AF ..... 60  
 MCL65AS ..... 60  
 MCL67 ..... 63  
 MCL68 ..... 63  
 MCL69 ..... 63  
 MCL76 ..... 9, 57  
 MCL77 ..... 59  
 MCL78 ..... 59  
 MCL79 ..... 59  
 MCL81BL ..... 64  
 MCL81BR..... 64  
 MCL81PL ..... 65

**M**

M832 ..... 38  
 M833 ..... 38

**MCEN**

MCEN39L ..... 65, 67  
 MCEN136SC ..... 89  
 MCEN770J30 ..... 19  
 MCEN770J40 ..... 19

**MCL**

MCL1BIS ..... 67  
 MCL4 ..... 67  
 MCL5 ..... 67  
 MCL7 ..... 67  
 MCL10 ..... 62  
 MCL11 ..... 64  
 MCL12 ..... 63  
 MCL15 ..... 63  
 MCL16 ..... 64  
 MCL17 ..... 64  
 MCL18 ..... 63  
 MCL19 ..... 63  
 MCL19BIS ..... 63  
 MCL25 ..... 63  
 MCL29 ..... 63  
 MCL30 ..... 63  
 MCL31 ..... 64  
 MCL33 ..... 63  
 MCL34 ..... 69

<sup>(D)</sup> Distribué par Integra MicroFrance SAS (France) - Voir tableau d'équivalence annexe pour la référence du fabricant correspondante

MCL81PR.....	65	MCL206A6.....	8
MCL82.....	64	MCL206A7.....	8
MCL83.....	60	MCL206C.....	7, 8
MCL83-1.....	60	MCL206K.....	8
MCL84.....	60	MCL206P.....	7, 8
MCL88.....	56	MCL210.....	62, 66
MCL88-1.....	56	MCL219.....	66
MCL88-2.....	56	MCL219-1.....	66
MCL89.....	60	MCL241.....	66
MCL89-1.....	9, 56, 60	MCL241-1.....	66
MCL89-2.....	9, 60	MCL290.....	60
MCL93.....	64	MCL291.....	60
MCL93-2.....	64	MCL291AD.....	60
MCL94.....	64	MCL291AG.....	60
MCL94G.....	67	MCL291FD.....	60
MCL94IG.....	67	MCL291FG.....	60
MCL94IP.....	65	MCL294.....	60
MCL94IPR.....	65	MCL295.....	60
MCL98.....	68	MCL320.....	54
MCL100.....	9, 62	MCL320F.....	54
MCL100T15.....	62	MCL330.....	54
MCL100T20.....	62	MCL330F.....	54
MCL101.....	68	MCL340.....	69
MCL102.....	68	MCL359.....	27
MCL103.....	62	MCL828.....	65
MCL110.....	55	MCL828C.....	67
MCL111.....	55	MCL920L25.....	55
MCL112.....	55	MCL920L30.....	56
MCL112F.....	55	MCL920L35.....	55
MCL112H.....	54, 55	MCL920L45.....	54
MCL120.....	61	MCL920L55.....	54
MCL121.....	61	MCL925L25.....	55
MCL122.....	61	MCL925L30.....	56
MCL123.....	61	MCL925L35.....	55
MCL124.....	61	MCL925L45.....	54
MCL124FL.....	61	MCL925L55.....	54
MCL124FR.....	61	MCL930L25.....	55
MCL124ST.....	61	MCL930L30.....	56
MCL125.....	61	MCL930L35.....	55
MCL125FL.....	61	MCL930L45.....	54
MCL125FR.....	61	MCL930L55.....	54
MCL125ST.....	61	MCL935L25.....	55
MCL170(D)(1).....	9, 57	MCL935L30.....	56
MCL171(D)(1).....	9, 57	MCL935L35.....	55
MCL173(D)(1).....	9, 57	MCL935L45.....	54
MCL174(D)(1).....	9, 57	MCL935L55.....	54
MCL197(D)(1).....	9, 57	MCL940L25.....	55
MCL205.....	66	MCL940L30.....	56
MCL206.....	8	MCL940L35.....	55
MCL206A1.....	7, 8	MCL940L45.....	54
MCL206A2.....	8	MCL940L55.....	54
MCL206A3.....	8		
MCL206A4.....	8		
MCL206A5.....	8		

## MCLB

MCLB16.....	74
MCLB17.....	74
MCLB30.....	74
MCLB31.....	74
MCLB94.....	74

## MCLP

MCLP10.....	75
MCLP20U.....	75
MCLP25U.....	75
MCLP30U.....	75
MCLP40U.....	75
MCLP50.....	75
MCLP60.....	75
MCLP70.....	75

## MCL-S

MCL-S0.....	71
MCL-S1.....	71
MCL-S2.....	71
MCL-S3.....	71
MCL-S4.....	71
MCL-S5.....	71
MCL-S6.....	71
MCL-S7.....	71
MCL-S8.....	71
MCL-S9.....	71
MCL-S10.....	71
MCL-S11.....	71
MCL-S12.....	71
MCL-S13.....	71
MCL-S14.....	71
MCL-S15.....	71
MCL-S16.....	62
MCL-S17.....	62
MCL-S17-1.....	62
MCL-S18.....	72
MCL-S18R.....	74
MCL-S19.....	71
MCL-S20.....	71
MCL-S21.....	72
MCL-S21R.....	74
MCL-S22.....	72
MCL-S22R.....	74
MCL-S23.....	72
MCL-S23R.....	74
MCL-S24.....	72
MCL-S24R.....	74
MCL-S25.....	71
MCL-S26.....	71

<sup>(1)</sup> Produit non dispositif médical

<sup>(2)</sup> Distribué par Integra MicroFrance SAS (France) - Voir tableau d'équivalence annexe pour la référence du fabricant correspondante

MCL-S27.....	71
MCL-S35.....	71
MCL-S38.....	71
MCL-S39.....	72
MCL-S41.....	72
MCL-S42.....	73
MCL-S43.....	73
MCLS44.....	73
MCLS45.....	73
MCLS46.....	73
MCLS47.....	73
MCLS48.....	73
MCLS49.....	73
MCLS50.....	73
MCLS51.....	73
MCLS52.....	73
MCLS53.....	73
MCLS54.....	73
MCLS55.....	73
MCLS56.....	73
MCLS57.....	73
MCLS58.....	73
MCLS59.....	73
MCLS60.....	73
MCLS61.....	73
MCLS62SC.....	73
MCLS63.....	73
MCLS64.....	73
MCLS65.....	73
MCLS66.....	73
MCLS120-1.....	61
MCLS120-2.....	61
MCLS120-3.....	61
MCLS121-1.....	61
MCLS121-2.....	61
MCLS121-3.....	61
MCLS122-1.....	61
MCLS122-2.....	61
MCLS122-3.....	61
MCLS123-1.....	61
MCLS123-2.....	61
MCLS1233.....	61

### MCLT

MCLT10.....	76
MCLT11.....	76
MCLT12R.....	76
MCLT13R.....	76
MCLT20.....	76
MCLT21.....	76
MCLT21R.....	76
MCLT30.....	76
MCLT40.....	76

MCLT40R.....	76
MCLT50.....	76
MCLT50R.....	76

### MCLW

MCLW10.....	68
MCLW11.....	68

### MCM

MCM1R.....	18
MCM4BISR.....	17
MCM4R.....	17
MCM7BISR.....	18
MCM7R.....	18
MCM10-0-5.....	17
MCM10-1-0.....	17
MCM12R.....	18
MCM13.....	17
MCM13-1.....	17
MCM25-3.....	9, 18
MCM970.....	18
MCM973D3.....	17
MCM973D5.....	17

### MCO

MCO201-2-5.....	19
MCO201-3-0.....	19
MCO305.....	20
MCO770-1-5.....	19
MCO770-2-0.....	19
MCO770-2-5.....	19
MCO770-3-0.....	19
MCO770-3-5.....	19
MCO770-4-0.....	19
MCO771-2-5.....	19
MCO771-3-0.....	19
MCO771-4-0.....	19
MCO803.....	20
MCO979.....	22
MCO988.....	22

### MCR

MCR2A.....	3
MCR3A.....	3

### P

P761-7.....	50
P761-8.....	50
P762-2.....	51
P762-4.....	51
P763.....	52
P764-1.....	51
P764-3.....	51
P764-5.....	51
P764-7.....	51
P764-11.....	51
P765-14.....	52
P765-16.....	52
P769.....	52
P770.....	53
P771.....	53

### S

SM63(D).....	67
SM64(D).....	67
SM65(D).....	67

<sup>(D)</sup> Distribué par Integra MicroFrance SAS (France) - Voir tableau d'équivalence annexe pour la référence du fabricant correspondante







**Tableau d'équivalence  
à titre informatif**

Integra MicroFrance® référence produit	Référence fabricant équivalente
1003IG	M3IG
1003LI	M3LI
1004IG	M4IG
1005I	M5I
7798T	101
7798T1	101 B
7872-24	1224
7876-100	310
7876-120	312
7876-160	316
7876-60	306
7876-80	308
7960T40	731901
MCL170 <sup>(1)</sup>	CO101
MCL171 <sup>(1)</sup>	CO201
MCL173 <sup>(1)</sup>	CO100
MCL174 <sup>(1)</sup>	CO200
MCL197 <sup>(1)</sup>	CO103
MCL38N	EC-BLU50U090
SM63	SM63
SM64	SM64
SM65	SM65

<sup>(1)</sup> Produit non dispositif médical





Integra MicroFrance SAS (France)  
Le Pavillon ■ 03160 Saint Aubin le Monial ■ France



Swann Morton Ltd  
Penn Works ■ Owlerton Green ■ Sheffield  
South Yorkshire S6 2BJ ■ Royaume Uni



Emergo Europe  
Prinsessegracht 20  
2514 AP The Hague ■ Pays-Bas

CE Class I products only :



Agencinox  
Zone Industrielle  
89110 Aillant sur Tholon ■ France



Directa AB  
Box 723  
19427 Upplands Vasby ■ Suède



Sunoptic Technologies  
6018 Bowdendale Avenue  
Jacksonville 32216 ■ Florida USA



AJW Technology Consulting GmbH  
Breite Straße 3  
40213 Düsseldorf ■ Allemagne

### Informations supplémentaires pour les clients Europe, Moyen-Orient, Afrique :

**Attention :** la loi restreint la vente de ces appareils à des médecins ou suite à leur prescription.

Tous les dispositifs médicaux mentionnés dans ce document sont marqués CE conformément aux lois européennes applicables, sauf mention spécifique "PAS DE MARQUAGE CE". Les références qui ne sont pas des dispositifs médicaux sont identifiées avec la mention "PRODUIT NON DISPOSITIF MEDICAL".

Les produits mentionnés dans ce document ne sont pas inscrits à la Liste des Produits et Prestations Remboursables (LPPR) mentionnée à l'article L165-1 du code de la sécurité sociale et ne sont pas éligibles au remboursement par l'Assurance Maladie.

Tous les textes et diagrammes contenus dans ce catalogue sont à considérer comme des notes d'orientations et sont à but illustratif seulement. Aucune information contenue dans ce catalogue n'a pour but de se substituer au mode d'emploi présent dans chaque emballage des produits Integra. Veuillez toujours vous référer au mode d'emploi approprié pour les instructions cliniques complètes. Pour des informations supplémentaires techniques et cliniques sur les produits Integra, veuillez contacter votre spécialiste Integra. Lire attentivement la notice d'instructions du produit.

La disponibilité de ces produits peut varier d'un pays ou d'une région à l'autre du fait de procédures d'enregistrement réglementaires ou de conditions de vente locales spécifiques.

Les produits identifiés par le symbole (D) sont distribués par Integra MicroFrance SAS (France).

Produits de classe I, Is, Ila, Ilb. Pour plus d'informations sur la classe des produits, veuillez contacter le Service Client Integra.

Consultez les étiquettes et les notices des produits pour connaître les indications, les contre-indications, les dangers, les avertissements et les précautions à prendre.

Date de dernière révision: 06/2023

## Pour plus d'informations, veuillez contacter le service client :

### Europe, Moyen-Orient, Afrique

International : +33 (0) 437 47 59 50 ■ +33 (0) 437 47 59 25 (Fax) ■ [csemea@integralife.com](mailto:csemea@integralife.com)  
France : +33 (0) 437 47 59 10 ■ +33 (0) 437 47 59 29 (Fax) ■ [custservfrance@integralife.com](mailto:custservfrance@integralife.com)  
Royaume-Uni : +44 (0) 1264 312 725 ■ +44 (0) 1264 312 821 (Fax) ■ [custsvcs.uk@integralife.com](mailto:custsvcs.uk@integralife.com)  
Belgique & Luxembourg : +32 (0)2 257 4130 ■ +32 (0)2 253 2466 (Fax) ■ [custsvcbenelux@integralife.com](mailto:custsvcbenelux@integralife.com)  
Pays-Bas : +31(0) 852 083 167 ■ +31(0) 207 093 627 (Fax) ■ [custsvcnetherlands@integralife.com](mailto:custsvcnetherlands@integralife.com)  
Italie : +39 (0)2 577 8921 ■ +39 (0)2 575 113 71 (Fax) ■ [custsvcityaly@integralife.com](mailto:custsvcityaly@integralife.com)  
[integralife.eu/contact](http://integralife.eu/contact)

MicroFrance, Integra et le logo Integra sont des marques enregistrées de Integra LifeSciences Corporation ou de ses filiales aux USA et/ou dans d'autres pays. Toutes les autres marques et noms de produits sont la propriété de leurs propriétaires respectifs.

©2023 Integra LifeSciences Corporation. Tous droits réservés.

0329661-6-FR

DOCUMENT DESTINE A L'EUROPE, AU MOYEN-ORIENT ET A L'AFRIQUE UNIQUEMENT.